



PRICE BOOK

EFFECTIVE JULY 3rd, 2023

SECURING
CONFIDENCE.
OPENING
POSSIBILITIES.



Customer Support

Customer Support

Our Customer Support team is available to answer questions or provide any assistance you may need.

717.656.4281, help@pdqlocks.com.

Monday through Friday – 8am to 5pm EST.

Placing Orders

To place orders, email:

orders@pdqlocks.com

Product and Technical Support

PDQ Mechanical: 833.273.7832, support@pdqlocks.com

Quotation and Product Cross Reference

quotes@pdqlocks.com, 717.656.4281

Value Engineering Services (Complimentary)

quotes@pdqlocks.com, 717.656.4281

Specification Writing Services (Complimentary)

quotes@pdqlocks.com, 717.656.4281

World Headquarters Administrative Office U.S. Manufacturing Center

PDQ Manufacturing
2230 Embassy Drive
Lancaster, PA 17603 USA

Remittances

PDQ Manufacturing
P.O. Box 6426
Lancaster, PA 17607 USA

Regional Distribution Centers

Lancaster, PA, Norcross, GA, Auburn, WA

International Sales and Distribution Centers

Abu Dhabi, United Arab Emirates

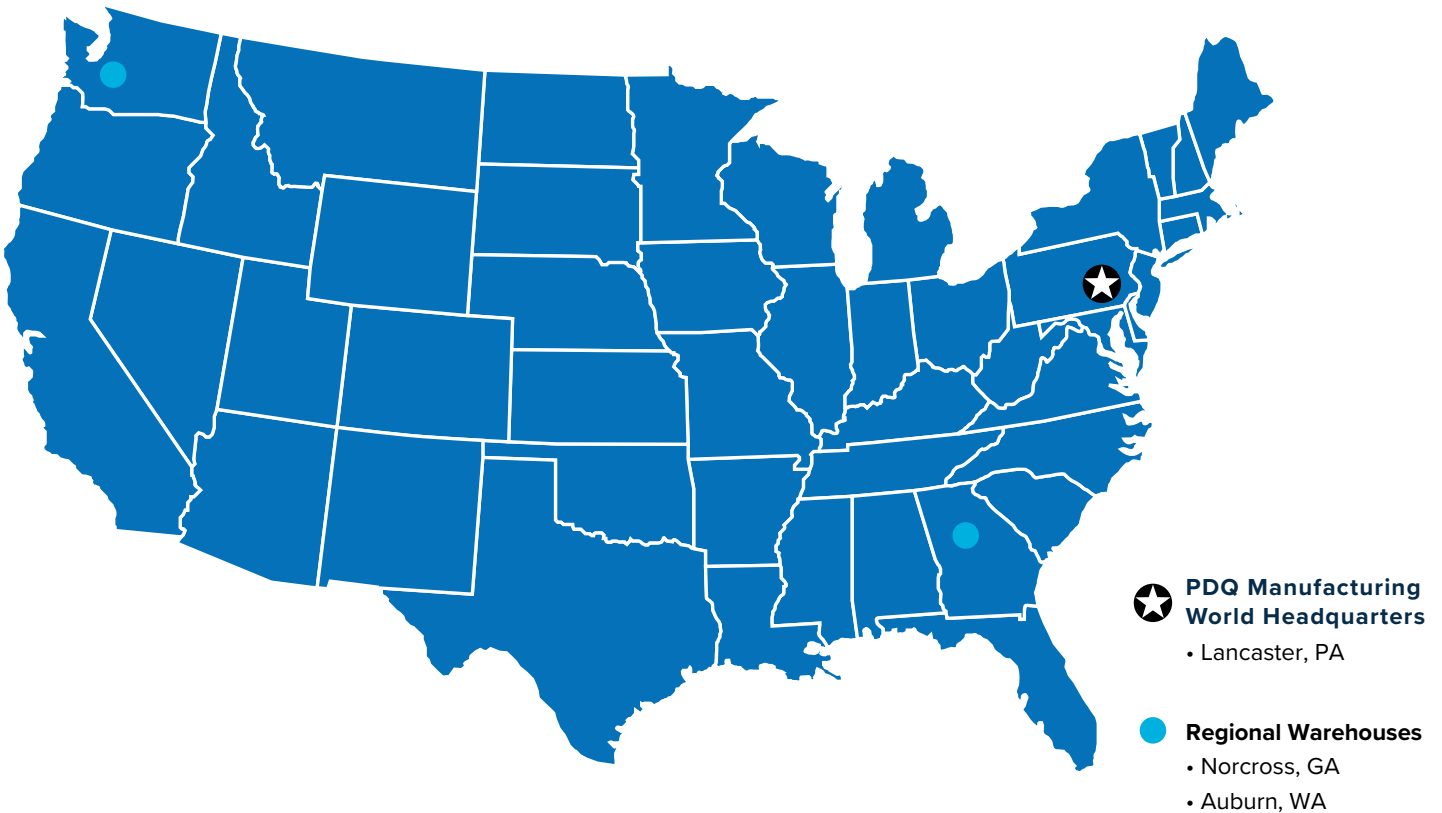



Table of Contents

Common Pricing Information	4	Door Closers	186
Terms & Conditions	5	7100 Series Grade 1 Closer	187
Warranty	6	5100 Series Grade 1 Closer	193
Mortise Locks	10	5300/5500 Series Grade 1 Closer	199
MR Series Grade 1 Mortise	10	3100 Series Grade 1 Closer	206
TJ Tubular Trim Suite	29	SCS Spring Cushion Stop	214
Cylindrical Locks Grade 1	33	Electrified Solutions	215
XGT/GT199A Series Grade 1 Electrified Cylindrical	34	Electric Strikes	217
XGT/GT135LED Classroom Intruder	35	Key Switches and Push Buttons	218
XGT Series Grade 1 Cylindrical	36	Power Supplies	219
GT Series Grade 1 Cylindrical	46	Hinges	220
SX Series Grade 1 Ball Knob	57	Commercial Hinges	221
Cylindrical Locks Grade 2	63	Electrified Hinges	226
GP Series Grade 2 Cylindrical	64	Flat Goods	227
SD Series Grade 2 Cylindrical	72	Flush and Surface Bolts	229
SF Series Grade 2 Cylindrical	80	Coordinators	232
CL Series Inter-Connected Grade 2	85	Push Plates	235
SV Series Grade 2 Ball Knob	92	Pulls and Pull Plates	237
Deadbolts	98	Push and Push-Pull Bars	244
KM Series Heavy Duty Bored Deadbolt — Rim Cylinder	99	Fasteners	246
KT Series Heavy Duty Bored Deadbolt — Mortise Cylinder	104	Door Protection Plates	247
KV Series Commercial Duty Bored Deadbolt — Rim Cylinder	108	General Hardware	249
MJ Mortise Cylinder Deadbolt	111	Sliding Barn Door Hardware	253
Padlocks, Euro Profile	113	Key Systems and Keying Forms	255
PL Series Padlock	113		
EPIC Series European Profile Interchangeable Core	115		
Cylinders, Keying Systems and Keys	117		
High Security Cylinders & Cores	118		
Cylinders	120		
Interchangeable Cores, Housings, Cams	123		
Keys & Keying Systems	126		
Exit Devices	128		
6300/6400R Rim	130		
6300/6400V Surface Vertical Rod	133		
6300/6400C Concealed Vertical Rod	137		
6300M Mortise	141		
6300D Dummy	144		
6300/6400 Parts	151		
6300/6400 Trim	156		
9300 Mullions	172		
4200 Commercial Exit Device	175		
4200R Rim	177		
4200V Surface Vertical Rod	178		
4200 Trim	179		

Common Pricing Information

1.	Locks are furnished with standard features unless otherwise specified.
2.	Door thickness is 1-3/4" unless otherwise specified.
3.	Split finishes and designs will be priced at the highest list price of the design and/or finish + lock adjustment.
4.	 Light blue shaded cell denotes a lock or part that requires an extended lead time.
5.	 denotes a handed product and requires handing to be specified.
6.	For all restricted keyways (TA, PDQ3) and additional high security and restricted keyways see page 125.
7.	Locks, keys and cylinders containing restricted keyways require additional documentation to order. A letter of authorization on the end user's stationary must be submitted with the initial order to establish the authorized ship to location.
8.	Keyway must be specified for keyed functions and cylinder. If not specified, the default keyway will be SCC.
9.	Multiple keying options are available. Locks and cylinders are furnished KD unless otherwise specified or excepted by notation.
10.	Control Keys for permanent and construction cores are not included with the lock or cylinder and must be ordered separately.
11.	Stamping standards and charges are listed on page 126.
12.	Locks and cylinders will be furnished with 2 keys each as standard. Additional keys will be charged at the additional cut key charge appropriate for the cylinder/key type.

Customer Support

Customer Service	717.656.4281	help@pdqlocks.com
Placing Orders		orders@pdqlocks.com
Technical Support	833.2-PDQTEC (833.273.7832)	support@pdqlocks.com
Quotation	717.656.4281	quotes@pdqlocks.com

This Price List Supersedes and Cancels All Previous Price Lists. Prices Shown are Subject to Change Without Notice.

Terms & Conditions

Prices

All prices are subject to change without notice. All prices are per unit (each) unless otherwise specified and do not include freight. All prices are in U.S. dollars.

Errors and Omissions

While PDQ Manufacturing makes every effort to provide an accurate price list, we are not responsible for errors and/or omissions that may appear. Customers will be invoiced the actual and true price on all orders.

Credit Terms

Standard credit terms are 1% 10 days net 30. Net 30 days payment must be received by PDQ on or before 30 days from the date of the invoice. Interest will be charged at the rate of 1-1/2% per month on past due accounts. A \$25.00 fee will be charged for all returned payments.

Acceptance of Orders

Possession of prices from PDQ Manufacturing does not commit PDQ to accept any order. PDQ Industries reserves the right to refuse any order or request for quotation and will not be bound to fill any order until it has been accepted by a representative of PDQ and confirmed by a written acknowledgment. Quotations are valid for the period stated on the official quotation request form. Orders must be submitted in writing.

Acknowledgments

An Acknowledgment is an exact copy of a customer's order as entered by PDQ and should be verified by the customer. If the Acknowledgment does not agree with customer's understanding, PDQ should be advised within three (3) days or the order will be billed as acknowledged. PDQ Manufacturing's sales terms shall apply irrespective of any special stipulation appearing in customer orders, unless specifically acknowledged and accepted by PDQ Manufacturing, Inc. Estimates of delivery are made by PDQ Manufacturing in good faith and are not guaranteed. PDQ Manufacturing does not assume responsibility for delay in deliveries.

Product Will Call Orders

Product Will Call orders shall be picked-up within 3 working dates from the available date shown on the acknowledgment. Orders not picked-up after the 3 days shall be subject to cancellation charges.

Product Return

Products may not be returned unless customer receives written authorization from PDQ. If the return is authorized by PDQ a Return Goods Authorization (RGA) number will be issued to the customer. Products returned must have the RGA number clearly marked on the outside of the box and reach PDQ within 45 days from the date RGA is issued. All documentation and RGA number must accompany the return along with the original invoice number and an explanation why the material is being returned so that PDQ may inspect the material in question. Only material that has been in customer's inventory for less than 60 days from the invoice date, is current standard, non-obsolete and not specially manufactured, unused and in their original condition and original packaging will be considered for return. Master keyed items cannot be returned for credit. If the product is accepted for a return there will be minimum 35% processing charge of the net material value on the original invoice, less freight and cash discounts. Full credit against future purchases or replacements will be made at the option of PDQ. Care must be taken to package all returns to ensure that they are not damaged in shipment. PDQ will not credit items returned that have not been properly packed and as a result sustain damage in shipment back to our facility

Force Majeure

PDQ will not be held responsible for delays in delivery caused by Strikes, acts by government agencies, fires, floods or any other causes beyond our control, including the delivery of material to us. Under no circumstances shall PDQ be liable or accountable for consequential damages due to failure of delivery.

Invoices

Copies of invoices and sales orders are posted and accessible on PDQ's website. Contact Customer Service for obtaining secured access authorization. Invoices are in U.S. dollars.

Minimum Order

Minimum order is \$100 net invoice value at current buying program, less freight.

Changes or Cancellations

Changes or cancellations to an order acknowledged must be made in writing subject to a 50% cancellation fee.

Claims

Every possible care is taken in the final examination and packing of goods, and no complaints can be entertained unless made promptly on receipt of goods. No claim will be allowed for work done by others, consequential damages, or other expenditure, and PDQ's undertaking to repair or replace defective goods is its only liability. No claim for damage, shortage or loss in transit will be considered unless notice in writing is given to the carrier and to PDQ Industries within ten (10) days.

Back Charges

PDQ is not responsible for, does not authorize, and will not accept any charges for the cost of labor or material incurred by anyone other than PDQ Manufacturing for any installation, repair, service or replacement unless incurred with PDQ's prior written consent and agreement.

Freight Charges

FOB point is Lancaster, PA, Norcross, GA, or Auburn, WA. Ship location is at factory discretion. Freight is prepaid if invoice exceeds \$3,000 net. Air freight and other special shipments are not deductible. Freight allowance methods are at the discretion of PDQ. C.O.D. freight charges are paid by consignee.

Credit Card Payments

When paying by credit card a 3% surcharge will be added to the invoice at time of payment.

Discontinuance

PDQ Manufacturing reserves the right to discontinue or change any price, product, design, function and finish without notice.

Quotations and Invoices

Quotations and Invoices are the proprietary property of PDQ Distributors and the Company. Distributors are not permitted to redistribute quotations or invoices to third parties. Any redistribution may result in the loss of the distributor's rights to the PDQ product line.



Warranty

PDQ Manufacturing Limited Warranty

Grade 1 Lock Product	
MR Series Mortise Locks	Limited Lifetime Warranty
XGT Series	Limited Lifetime Warranty
GT Series	25-Year Warranty
SX Series	5-Year Warranty
Grade 2 Lock Product	
GP Series	8-Year Warranty
SD Series	5-Year Warranty
SF Series	3-Year Warranty
SV Series	1-Year Warranty
CL Series	2-Year Warranty
TJ Series Decorative Tubular	
TJ Series	5-Year Warranty
Deadbolts	
K Series	1-Year Warranty
Closers	
3100 Series	25-Year Warranty
5100 Series	25-Year Warranty
5300 Series	25-Year Warranty
5500 Series	25-Year Warranty
7100 Series	25-Year Warranty
Exit Devices	
4200 Series	5-Year Warranty
6300 Series	10-Year Warranty
6400 Series	10-Year Warranty
Mullions	
Mullions	10-Year Warranty
Hinges, Flat Goods and Sliding Barn Door Hardware	
Commercial Hinges	5-Year Warranty
Flat Goods	5-Year Warranty
Sliding Barn Door Hardware	5-Year Warranty
Electrified Products	
Mechanical Components	Series Warranty
Electric Components	2-Year Warranty

PDQ Manufacturing ("PDQ") warrants that, during the applicable warranty period set forth in the chart to the left, its products will be free from defects in workmanship and materials under normal use and service conditions. If a product or a component part thereof is found to be defective, PDQ will, at its sole discretion, either repair or replace such defective item. If PDQ no longer manufactures the particular product or component, PDQ reserves the right to substitute an item which PDQ deems to be comparable or superior in its place.

A warranty claim must be initiated by calling PDQ's toll-free number at 800.441.9692. A brief description of the defect will be required, and further instructions for returning the product will be given. The provision of return instructions is not a guarantee that the product will be covered under this warranty.

This warranty does not cover:

- Defects or damage arising from improper installation; lack of or improper maintenance; improper storage, shipping or handling; corrosion; erosion; ordinary wear and tear; misuse or abuse; or accident.
- Products which have been modified in any way, regardless of whether such modification caused or contributed to the alleged defect.
- The protective coatings and finishes applied to the surface of the product (wear or tarnishing of such finishes is considered "ordinary wear and tear").
- Labor costs, including the costs of removing and reinstalling the product.
- Shipping charges incurred in returning the product to PDQ.
- This Limited Warranty does not apply to ANSI A156.2 Grade 2 Key-In-Lever product installed on Educational Facilities.

All products returned to PDQ will be inspected to verify that (1) the alleged defect does exist, and (2) none of the exclusionary conditions listed above (abuse, corrosion, modification, etc.) is present. Products deemed not to be "in warranty" will be returned to the customer at the customer's expense.

This warranty is exclusive and in lieu of all other warranties, express and implied, including the implied warranties of merchantability and fitness for a particular purpose.

PDQ's maximum liability hereunder is limited to the original purchase price of the product.

PDQ shall not be liable for any incidental, consequential, indirect, special, exemplary or punitive damages, whether based on contract, warranty, tort (including strict liability and negligence), patent infringement or any other theory of liability, even if advised of the possibility of such damage.

No agent, sales representative or dealer has the authority to increase or alter PDQ's obligations under this warranty.



ASSEMBLED
IN THE USA

Designed to Over-Perform

Tested to 11 million cycles and still counting! That's how PDQ backs up its claim to manufacture some of the toughest hardware in the market. Our mortise locks are built to withstand the rigors of daily use without fail, keeping people and their assets safe while delivering consistent reliable performance. Easy to install, and simple to repair and maintain. That means fewer callbacks for you and total safety and security for your customers.

Comprehensive Offering

MR Mechanical

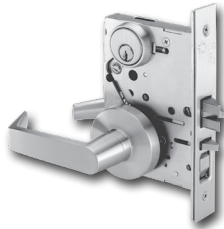

Applications

Healthcare, K-12, higher education, offices, commercial buildings and government facilities.

MR199A Electro-Mechanical

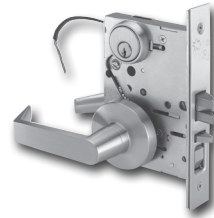

Applications

Computer rooms, storage areas, child care facilities, restrooms, nursing staff lounges and stairwell towers.

MR Visual Indicators



Applications

Classroom security, student housing and traditional OCCUPIED/VACANT and LOCKED/UNLOCKED applications.

TJ Tubular Trim Suite

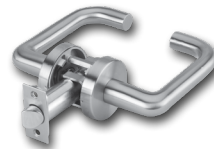

Applications

Interior doors in high-end residential, multi-family and commercial spaces. Trim matches MR mortise achieving a coordinated look throughout the property.

Lock Status at a Glance

PDQ's MR Series mortise lock indicators offer exceptional visibility and flexibility. The unique features of the indicator make it ideally suited for classroom security applications as well as traditional occupied/vacant applications.

Typical Applications

- Classroom Security
- LOCKED/UNLOCKED Applications
- Student Housing
- Traditional OCCUPIED/VACANT Applications



Features and Functions

- Conforms to ANSI Z535.1 Safety Colors: Red and Green
- Optional Security Screws Available
- Intruder Deadbolt with Dead-latch for School Security Applications
- Dormitory Security
- Faculty Restroom with Deadbolt w/Indicator
- Privacy w/Indicator
- Privacy with Deadbolt w/Indicator
- Privacy with Deadbolt and Egress w/Indicator



MR 199A MR200

Electrified Mortise Solutions



ASSEMBLED
IN THE USA

MR199A Electrified Storeroom MR200 Electrified Institutional

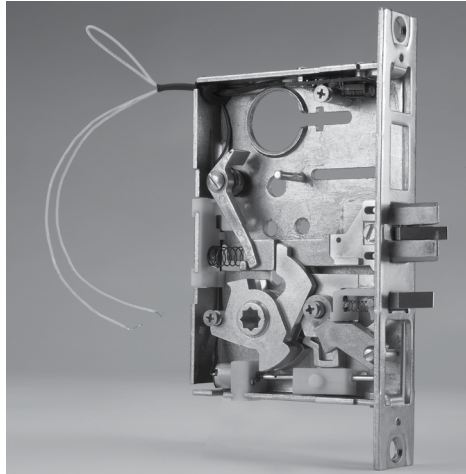

Innovative motor drive controls
FAIL SECURE or FAIL SAFE locking
mode.

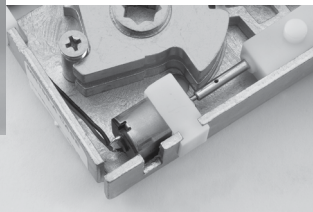

Typical Applications

- Child Care Facilities
- Computer Rooms
- Nursing Staff Lounges
- Rest Rooms
- Stairwell Towers
- Storage Areas

Features

- Motorized locking/unlocking.
- **FAIL SECURE** (Factory Default)– Outside trim is UNLOCKED when power is ON, and LOCKED when power is OFF. Lockset will lock in the event of a power failure.
- **FAIL SAFE** – Outside trim is LOCKED when power is ON, and UNLOCKED when power is OFF. Lockset will unlock in the event of a power failure.
- Field changeable from FAIL Secure to FAIL SAFE.
- Built around PDQ's world class MR series mortise lock chassis platform.
- Meets requirements of the Buy American Act.
- SMARTSENSE™ control board automatically accepts AC or DC input voltage.
- Request to exit option.
- Latch bolt monitor option.
- Field reversible handing - consult factory.

Specifications



PERFORMANCE:	<ul style="list-style-type: none"> • Motor drive factory tested to over 1.4 million cycles (nearly 3x the ANSI/BHMA Grade 1 Standard).
RECOMMENDED POWER SUPPLY:	<ul style="list-style-type: none"> • PDQ Model # PS220. <ul style="list-style-type: none"> – Input: 110-120 VAC 60Hz – Output: 24VDC, 2A, filtered and regulated. • Rated for simultaneous operation of 2ea mortise lock assemblies. • Power Supply Requirements: <ul style="list-style-type: none"> – AC/DC Output Voltage – 1A min (filtered and regulated). • 12-24VDC @ < 1A initial surge (1 sec), 5mA standby after 30 sec. – AC Output Voltage. • 12-24VAC (60Hz) @ < 1A initial surge (1 sec), 15mA standby after 30 sec
ELECTRICAL SPECIFICATIONS:	<ul style="list-style-type: none"> • Input voltage: 12-24VDC or 12-24VAC. • Max In-rush current: 1.0A. • Standby current: <ul style="list-style-type: none"> – 12VAC: 12mA. – 24VAC: 10mA. – 12VDC: 3mA. – 24VDC: 5mA. <p>Note: Operating voltage at ± 10% of rated voltage.</p>
CERTIFICATIONS, LISTINGS, COMPLIANCES:	<ul style="list-style-type: none"> • ANSI/UL10C and CAN/ULC-5104 Listed for "Fire Exit Hardware" up to 3 hours for 4'0" x 8'0" maximum single, 8'0" x 8'0" maximum pairs. • Assembled in the U.S.A. with U.S. and foreign material. Meets requirements of the Buy American Act as a COTS product manufactured in the United States.
WARRANTY:	<ul style="list-style-type: none"> • 2-Years

MR SERIES

Grade 1 Mortise



ASSEMBLED
IN THE USA

Typical Applications

- Assisted Living
- Government Facilities
- Healthcare
- Hospitality
- Houses of Worship
- Industrial
- Multi-family
- Offices
- Public Buildings
- Retail
- Higher Education
- K-12 Education

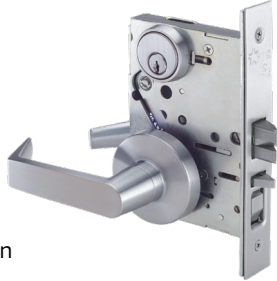

Specifications



FOR DOORS:	• 1-3/4" standard, 2"-3" thick doors available as special order
BACKSET:	• 2-3/4"
CASE:	• 12-gauge cold rolled steel mechanism • Dichromated for corrosion resistance • Features weakened spindle design to prevent case damage
ARMOR FRONT:	• Beveled 1/8" on 2" • 625 (US26) & 630 (US32D) use stainless steel as base material, all other finishes use stainless steel or brass as base material
STRIKE:	• Non-handed Curved Lip Strike • 625 (US26) & 630 (US32D) use stainless steel as base material, all other finishes use stainless steel or brass as base material
LEVERS:	• F Series Sectional/Escutcheon: Philadelphia, Boston, Miami • J Series Sectional/Escutcheon: Philadelphia, Boston, Miami, Chicago, Dallas, Houston, Los Angeles, Memphis, Orlando, Ball Knob
LATCHBOLT:	• 3/4" Throw • Investment Cast Stainless Steel • Anti-friction
DEADBOLT:	• 1" Throw • Investment Cast Stainless Steel
HAND:	• Most functions field reversible. Specify handing for Strikes, consult factory for details
TRIM:	• F trim - forged brass levers and escutcheons • Round and square rose available • J Trim - stainless steel sectional/escutcheon trim and levers, PHL, MEM, MIA and BSN are solid levers LAX, ORL, DAL and CHI are tube levers
KEYS:	• Two (2) per Lock
KEYWAYS:	• SCC standard (Schlage C Compatible) • Also available in keyways of other manufacturers
INTERCHANGEABLE CORE:	• 6 or 7-pin • Compatible with Best, Falcon & Arrow • Large Format IC Cores compatible with Schlage.
CYLINDER:	• 6 or 7-pin Brass Mortise Cylinder • Standard High Security and UL437 Cylinders Available
KEYING:	• Options: MK, CMK or GMK • Zero Bitted (KO), Keyed Different (KD) or Keyed Alike (KA) Can be keyed into existing master key systems
FINISHES:	• F Series Trim: 626 (US26D) • J Trim: 605 (US3), 606 (US4), 612 (US10), 613E, 622 (US19), 629 (US32), 630 (US32D) • Antimicrobial Coating available on 626 (US26D) & 630 (US32D) for F and J Trim.
PERFORMANCE:	• Tested to over 11 million cycles, 11X ANSI/BHMA standard
CERTIFICATIONS, LISTINGS, COMPLIANCES:	• UL listed for 3 hrs, for single doors up to 4'0" x 8'0" • Certified to ANSI/BHMA 156.13 Operational Grade 1 and Security Grade 1 • Approved for Florida HVHZ (High Velocity Hurricane Zone). PDQ Product Approval: FL 21376. Design load rating: ± 70.0 PSF for single door (3' x 7') • Complies with ADA (Americans with Disabilities Act) and ICC/ANSI 117.1 for Accessible and Usable Buildings • J Wide Escutcheon Trim complies with Unified Facilities Guide Specification 08 71 00 (August 2008)
WARRANTY:	• Lifetime Limited Warranty
COUNTRY OF ORIGIN:	• Assembled in the U.S.A. with U.S. and foreign material. Meets requirements of the Buy American Act as a COTS product manufactured in the United States.

Note: Heavy Duty Spindle for High Abuse situations is available for F trim.

‡ Available with antimicrobial coating, technology that is known to inhibit the growth of microbes.

MR SERIES



LIST PRICE

Effective July 3, 2023

Locksets/Trim

Notes:

- 1 - Lock adjustment for Square Rose, Wide J Trim, see page 13.
- 2 - Finishes 605, 606 and 612 consult factory for lead-time.
- 3 - F-Trim available in 626 only.

SECTIONAL			ESCUTCHEON		
					
SERIES:	F SERIES	J SERIES	F SERIES	J SERIES	
LEVERS:	PHL, BSN, MIA	ALL LEVERS & KNOB	PHL, BSN, MIA	ALL LEVERS & KNOB	
ROSE/ESCUTCHEON:	ROUND (SF)	ROUND (SJ) SQUARE (SR)	(EF) 2-1/16" W x 7-5/8" H	STANDARD (EJ): 1-3/4" W x 7-5/8" H WIDE (EW): 2-9/16" W x 8" H	

	ANSI NO.	FUNCTION	DESCRIPTION	626	630	605, 606, 612, 613E, 622, 629	626	630	605, 606, 612, 613E, 622, 629
NON-KEYED	F01	126	Passage	\$550.00	\$520.00	\$570.00	\$580.00	\$550.00	\$610.00
		174	Privacy with Thumbturn Both Sides	\$630.00	\$600.00	\$650.00	\$660.00	\$630.00	\$690.00
	F22	176	Privacy						
SINGLE CYLINDER	F06	113	Classroom Hold back Single Cyl	\$660.00	\$630.00	\$680.00	\$690.00	\$660.00	\$720.00
	F07	115	Storeroom						
	F04	116	Entry						
	F05	148	Classroom						
		149	Assisted Living						
		181	Office						
DOUBLE CYLINDER		114	Classroom Hold back Double Cyl	\$730.00	\$700.00	\$750.00	\$760.00	\$730.00	\$790.00
	F30	138	Institution						
	F09	186	Apartment Entrance						
NON-KEYED WITH DEADBOLT	F02	178	Privacy with Deadbolt	\$700.00	\$670.00	\$720.00	\$730.00	\$700.00	\$760.00
	F19	179	Privacy with Deadbolt and Egress						
SINGLE CYLINDER WITH DEADBOLT	F08	117	Front Door	\$685.00	\$655.00	\$705.00	\$715.00	\$685.00	\$745.00
	F21	135	Entrance, Storeroom						
	F13	136	Dormitory, Entrance						
		139	Closet, Storeroom						
		141	Storeroom with Deadbolt						
	F10	154	Entrance						
	F20	162	Apartment, Corridor						
		213	Double Cylinder and Thumbturn Deadbolt with Dummy Trim						
	215	Single Cylinder Deadbolt with Dummy Trim							
DOUBLE CYLINDER WITH DEADBOLT		128	Institution with Deadbolt	\$750.00	\$720.00	\$770.00	\$780.00	\$750.00	\$810.00
	F14	137	Store Door						
	F34	157	Intruder Deadbolt with Deadlatch						
	F11	158	Dormitory						
	F33	159	Dormitory						
		214	Double Cylinder and Thumbturn Deadbolt with Dummy Trim						
DEADLOCK	F18	131	Single Cylinder Deadbolt	\$420.00	\$390.00	\$440.00			
	F17	132	Cylinder and Thumbturn Deadbolt						
	F16	133	Double Cylinder Deadbolt	\$430.00	\$400.00	\$450.00			
	F29	134	Classroom Deadbolt						
ELECTRIFIED		199A	Storeroom, Single Cylinder	\$1030.00	\$1000.00	\$1050.00	\$1060.00	\$1030.00	\$1090.00
		200	Institutional, Double Cylinder	\$1060.00	\$1030.00	\$1080.00	\$1090.00	\$1060.00	\$1120.00
WITH INDICATORS	—	232	Privacy Single Cylinder Deadbolt w/Indicator	N/A	\$750.00	\$800.00	N/A	\$780.00	\$840.00
	F13	236	Dormitory, Entrance w/Indicator						
		241	Storeroom with Deadbolt w/Indicator						
	F34*	257	Intruder w/Indicator						
	F33*	259	Dormitory w/Indicator						
	F15*	260	Faculty Restroom w/Deadbolt w/Indicator						
		269	Privacy w/Indicator						
	F22*	276	Privacy w/Indicator						
	F02*	278	Privacy w/Deadbolt w/Indicator						
	F19*	279	Privacy w/Deadbolt and Egress w/Indicator						
DUMMY/ DUMMY TRIM		205	Double Dummy	\$390.00	\$360.00	\$410.00	\$420.00	\$390.00	\$450.00
		206	Double Dummy with Chassis	\$490.00	\$460.00	\$510.00	\$520.00	\$490.00	\$550.00
		207	Double Dummy with Active Trim						
		211	Single Dummy	\$210.00	\$180.00	\$205.00	\$240.00	\$210.00	\$240.00
		212	Single Dummy with Chassis	\$310.00	\$280.00	\$330.00	\$340.00	\$310.00	\$370.00

*w/Indicator

J Series Rose and Escutcheon Lock Adjustment

CODE	DESCRIPTION	LOCK ADJUSTMENT
		630, 605, 606, 612, 613E, 622, 629
SR	Sectional Square Rose - J Trim	\$20.00
EJ	Standard Width Escutcheon - J Trim Dimensions: 1-3/4" W x 7-5/8" H	N/C
EW	Wide Width Escutcheon - J Trim Dimensions: 2-9/16" W x 8" H	\$10.00 (Additional add to EJ List Price)
SJ	Sectional Round Rose - J Trim	N/C

F Type Levers



PHILADELPHIA — PF



BOSTON — BF



MIAMI — MF

J Type Levers



PHILADELPHIA — PJ



BOSTON — BJ



MIAMI — MJ



CHICAGO — CJ



DALLAS — DJ



HOUSTON — HJ



MEMPHIS — TJ



ORLANDO — OJ

(Specify handing)



LOS ANGELES — LJ



BALL KNOB — KJ*



ALL LEVERS

*Knobs are not ADA Compliant

CYLINDER OPTIONS	ICON
D	
SFL	
LFL	

IC Core not included see page 15 for core options

Sectional Trim



ROUND ROSE (SF)
F-TRIM



SQUARE ROSE (SR)
J-TRIM ONLY



ROUND ROSE (SJ)
J-TRIM

Escutcheon Trim



EF
STANDARD F



EJ
STANDARD J



EW
WIDE J

MR SERIES

LIST PRICE

Effective July 3, 2023

PDQ KEYWAY	COMPATIBLE WITH	SOLD WITH LOCK
AR1	Arrow / AR1	N/C
CO59A1	Corbin / 59A1	
CO6	Corbin / 60	
CL4	Corbin / L4	
RUD	Ruswin / D1	
SCE	Schlage / E	
SCC	Schlage / C	
SCC-K	Schlage / C-K	
SAL	Sargent / LA	
RA-RC	Sargent / RA-RC	
YA8	Yale / E1R	
GA	Yale / GA	
FAL	Falcon / E-R	
KW	Kwikset	
TA	PDQ / TA (Restricted. Limited to Grandmaster systems w/4 masters)	
Dummy	—	
T-Turn	—	
L	Less Cylinder	
HIGH SECURITY CYLINDERS AND CORES		
SEE HIGH SECURITY CYLINDERS AND CORES SECTION, PAGE 118.		

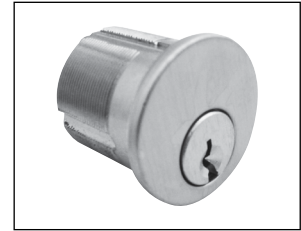

Mortise Cylinder

NOTES:

- Uncombined cores do not include springs & pins
- Combined cores include master keying in the list price
- **PDQ1, PDQ2, PDQ3 (Restricted)**
BEST A2 & A4 Systems Available
- Control Keys must be ordered separately

Cores and Keyways

DESCRIPTION	PDQ NO.	ADD
SMALL FORMAT UNCOMBINED		
6 Pin Cores	I5206 + KEYWAY	\$40.00
7 Pin Cores	I5207 + KEYWAY	
COMBINATED		
6 Pin Cores	I5206-1 + KEYWAY	\$60.00
7 Pin Cores	I5207-1 + KEYWAY	
BEST Compatible		
A (DEFAULT), B, C, D, E, F, G, H, J, K, L, M, Q,		
WA, WB, WC, WG, WH, TB, TD, TE, & R		
PDQ Exclusive		
PDQ1, PDQ2		
PDQ Exclusive and Restricted		
PDQ3		
SFIC CONSTRUCTION		
Construction Core 6-pin only		\$60.00
Dummy Construction Core Plastic		\$8.00
LFIC CONSTRUCTION		
Construction Core 6-pin only. Construction cores are invoiced at shipment and credited upon return.		\$70.00
IC Tailpiece Assembly		\$10.00
LFIC COMBINATED		
Schlage compatible LFIC, SCC (Schlage C compatible) keyway		\$70.00
PDQ TA LFIC Restricted		
LFIC UNCOMBINED		
Schlage compatible LFIC, SCC (Schlage C compatible) keyway		\$50.00
HIGH SECURITY IC CORES		

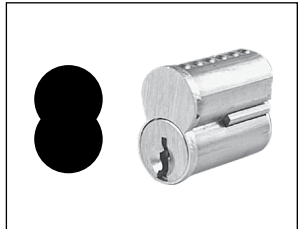

SFL/SFIC Core

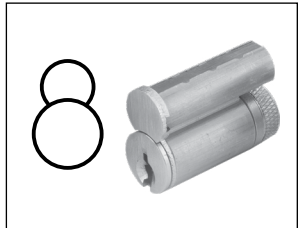

LFL/LFIC Schlage Format



IC Mortise Housing

Options

CODE	DESCRIPTION	LOCK ADJUSTMENT
TC1IS	Tactile Abrasive Coating - Inside only (PHL and MIA levers only)	\$25.00
TC1OS	Tactile Abrasive Coating - Outside only (PHL and MIA levers only)	
TC2	Tactile Abrasive Strip - Both Sides (PHL and MIA levers only)	\$50.00
SSM	Sectional Single Sided Mounting Assembly	
LL	Lead-wrapped Case	\$185.00
SHS	Security Head Screws	\$15.00
EASA	Extended Lip Strike (1-3/8, 1-5/8, 1-7/8)	\$10.00
REX	Request to Exit (Available for functions 199A and 200 only)	\$185.00
LM	Latch Bolt Monitoring	
SF	Split Finishes	Higher Finish Price
HDS	HD Spindle for high abuse applications (for F Trim Only)	\$35.00
AM	Antimicrobial Coating - Sectional Mortise Lock inside lever, rose, thumbturn, outside lever (Not available with 605 finish)	
AM	Antimicrobial Coating - Escutcheon Mortise Lock inside lever, rose, thumbturn, outside lever (Not available with 605 finish)	
ADA	Disability Turn (ADA) - for J Trim Only	\$10.00
TD1	MR adapted to accommodate 2-1/4"-2-1/2" thick door	\$65.00
TD2	MR adapted to accommodate 2-3/4" thick door	
TD3	MR adapted to accommodate 3" thick door	



Thick Door Installation Kits

DESCRIPTION	PDQ NO.	LIST PRICE
J TRIM SECTIONAL		\$150.00
2-1/2" door	W51447	
2-3/4" to 3" door	W51448	
J TRIM ESCUTCHEON AND ESCUTCHEON WIDE		\$150.00
2-1/2 -2-3/4" door	W51449	
3" door	W51450	

Note: Kits include hardware to install lock in center of door. Cylinders and strikes not included.

Strikes

DESCRIPTION	LIP LENGTH	PDQ NO.	LIST PRICE
1-1/4" x 4-7/8" ANSI/ASA Curved Lip (NON-HANDED)	1-3/16"	W51290-(designate finish)	\$30.00
Extended Straight Lip	1-7/8"	W51002-(designate finish)	\$40.00

Mortise Lock Body with Armor Plate

TYPE	LOCK BODY BY FUNCTION	PDQ NO.	LIST PRICE
Non-Keyed	126, 174, 176	Contact Customer Support	\$265
Non-Keyed Deadbolt	178, 179		\$290
Single Cylinder	113, 115, 116, 148, 149, 181		\$300
Single Cylinder Deadbolt	117, 135, 136, 139, 141, 154, 162, 213, 215		\$330
Double Cylinder	114, 138, 186		\$300
Double Cylinder Deadbolt	128, 137, 157, 158, 159, 214		\$330
Electrified	199A / 200		\$500
Electrified w/ REX	199A / 200 REX		\$550

Sectional Trim Packs* (Lever and Rose)

DESCRIPTION	PDQ NO.	LIST PRICE
Full Sectional Trim Pack (both sides of door), "F" or "J" Trim, All Functions*	Contact Customer Support	\$400.00
Half Sectional Trim Pack (one side of door), "F" or "J" Trim, All Functions*		\$200.00

* Note - Cylinders priced separate, See cylinders page 130

Escutcheon Trim Packs* (Lever and Escutcheon)



DESCRIPTION	PDQ NO.	LIST PRICE
Full Escutcheon Trim Pack (both sides of door), "F" or "J" Trim, All Functions*	Contact Customer Support	\$450.00
Half Escutcheon Trim Pack (one side of door), "F" or "J" Trim, All Functions*		\$225.00

* Note - Cylinders priced separate, See cylinders page 130





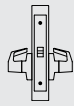
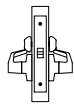

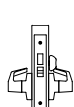
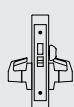
Miscellaneous Parts

DESCRIPTION	PDQ NO.	LIST PRICE
Cam (Corbin A01) For #16 mortise Cylinder	I127-4201	\$10.00
IC Cam for SFIC Mortise Housing	I54061	
IC Cam for LFIC Mortise housing	I54261	
Collar Cyl Vandal 3/8" (specify finish)	W51214	\$20.00
Collar Spring	W51049	\$8.00
Anti-Friction Latchbolt	W91904	\$40.00
1-3/8" Extended Straight Lip	W51002-1-3/8"	
1-3/4" Extended Straight Lip	W51002-1-5/8"	

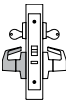

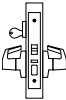

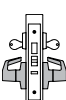

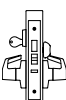
PDQ Functions – Non Keyed

FUNCTION	FUNCTION NUMBER	OUTSIDE INSIDE	DESCRIPTION	ANSI NUMBER
Passage	MR126		<ul style="list-style-type: none"> Latchbolt operated by lever from either side 	F01
Privacy with Thumbturn on Both Sides	MR174		<ul style="list-style-type: none"> Latchbolt operated by lever from either side Thumbturn outside locks/unlocks outside lever Thumbturn inside locks/unlocks outside lever Closing door unlocks outside lever Rotating inside lever unlocks outside lever 	—
Privacy	MR176		<ul style="list-style-type: none"> Latchbolt operated by lever from either side Emergency coin turn outside unlocks outside lever Thumbturn inside locks/unlocks outside lever Closing door unlocks outside lever Rotating inside lever unlocks outside lever 	F22
Privacy with Deadbolt	MR178		<ul style="list-style-type: none"> Latchbolt operated by lever from either side Emergency coin turn outside retracts deadbolt Thumbturn inside extends/retracts deadbolt Not field reversible Specify handing 	F02
Privacy with Deadbolt and Egress	MR179		<ul style="list-style-type: none"> Latchbolt operated by lever from either side Emergency coin turn outside retracts deadbolt Thumbturn inside extends/retracts deadbolt Inside lever simultaneously retracts latchbolt and deadbolt 	F19

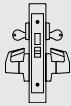
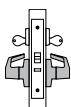
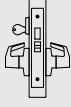
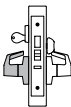
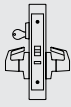

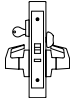

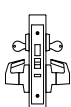

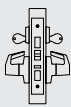
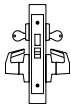
PDQ Functions – Keyed

FUNCTION	FUNCTION NUMBER	OUTSIDE INSIDE	DESCRIPTION	ANSI NUMBER
Hold Back Single Cylinder	MR113		<ul style="list-style-type: none"> Latchbolt operated by lever from inside Key outside retracts latchbolt Rigid outside lever Auxiliary latch deadlocks latchbolt Key outside secures latchbolt when latchbolt is retracted by inside lever Not field reversible Specify handing 	F06
Hold Back Double Cylinder	MR114		<ul style="list-style-type: none"> Latchbolt operated by lever from inside Key outside retracts latchbolt Rigid outside lever Auxiliary latch deadlocks latchbolt Key inside secures latchbolt when latchbolt is retracted by inside lever Not field reversible Specify handing 	—
Storeroom	MR115		<ul style="list-style-type: none"> Latchbolt operated by lever from inside Key outside retracts latchbolt Rigid outside lever Auxiliary latch deadlocks latchbolt 	F07
Entry	MR116		<ul style="list-style-type: none"> Latchbolt operated by lever from either side Toggle locks/unlocks outside lever Key outside retracts latchbolt Auxiliary latch deadlocks latchbolt 	F04
Front Door	MR117		<ul style="list-style-type: none"> Latchbolt operated by lever from either side Toggle locks/unlocks outside lever Key outside retracts latchbolt Key outside extends/retracts deadbolt Thumbturn inside extends/retracts deadbolt 	F08 or F10
Institution with Deadbolt	MR128		<ul style="list-style-type: none"> Key outside retracts latchbolt Key inside retracts latchbolt Key outside extends/retracts deadbolt Key inside extends/retracts deadbolt Rigid outside lever Rigid inside lever Auxiliary latch deadlocks latchbolt 	—
Entrance/Storeroom	MR135		<ul style="list-style-type: none"> Latchbolt operated by lever from either side Key outside extends/retracts deadbolt Thumbturn inside extends/retracts deadbolt 	F21
Dormitory/Exit	MR136		<ul style="list-style-type: none"> Latchbolt operated by lever from either side Key outside extends/retracts deadbolt Thumbturn inside extends/retracts deadbolt Inside lever simultaneously retracts latchbolt and deadbolt Auxiliary latch deadlocks latchbolt 	F13

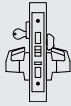
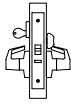
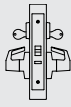
PDQ Functions – Keyed

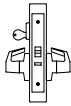
FUNCTION	FUNCTION NUMBER	OUTSIDE INSIDE	DESCRIPTION	ANSI NUMBER
Store Door	MR137		<ul style="list-style-type: none"> Latchbolt operated by lever from either side Key outside extends/retracts deadbolt Key inside extends/retracts deadbolt Latchbolt and deadbolt are independent of each other 	F14
Institution	MR138		<ul style="list-style-type: none"> Key outside retracts latchbolt Key inside retracts latchbolt Rigid outside lever Rigid inside lever Auxiliary latch deadlocks latchbolt 	F30
Closet / Storeroom	MR139		<ul style="list-style-type: none"> Latchbolt operated by lever from either side Key outside extends/retracts deadbolt 	—
Storeroom with Deadbolt	MR141		<ul style="list-style-type: none"> Latchbolt operated by lever from inside Key outside retracts latchbolt Key outside extends/retracts deadbolt Rigid outside lever Inside lever simultaneously retracts latchbolt and deadbolt Auxiliary latch deadlocks latchbolt Thumbturn inside extends/contracts deadbolt but doesn't effect outside lever. 	—
Classroom	MR148		<ul style="list-style-type: none"> Latchbolt operated by lever from either side Key outside retracts latchbolt Key outside locks/unlocks outside lever Inside lever always free Auxiliary latch deadlocks latchbolt 	—
Assisted Living	MR149		<ul style="list-style-type: none"> Latchbolt operated by lever from either side Key outside locks/unlocks outside lever Thumbturn inside locks/unlocks outside lever Closing door unlocks outside lever Rotating inside lever unlocks outside lever Auxiliary latch deadlocks latchbolt 	—
Entrance	MR154		<ul style="list-style-type: none"> Latchbolt operated by lever from either side Toggle locks/unlocks outside lever Key outside retracts latchbolt Key outside extends/retracts deadbolt Thumbturn inside extends/retracts deadbolt Inside lever simultaneously retracts latchbolt and deadbolt Auxiliary latch deadlocks latchbolt Projecting then retracting the deadbolt releases the toggle 	—
Intruder Deadbolt with Deadlatch	MR157		<ul style="list-style-type: none"> Latchbolt operated by lever from either side Key outside extends/retracts deadbolt Key inside extends/retracts deadbolt Inside lever simultaneously retracts latchbolt and deadbolt Auxiliary latch deadlocks latchbolt 	F34
Dormitory	MR158		<ul style="list-style-type: none"> Latchbolt operated by lever from either side Toggle locks/unlocks outside lever Key outside extends/retracts deadbolt Key inside extends/retracts deadbolt Inside lever simultaneously retracts latchbolt and deadbolt Auxiliary latch deadlocks latchbolt 	F11
Dormitory	MR159		<ul style="list-style-type: none"> Latchbolt operated by lever from either side Key outside extends/retracts deadbolt Key inside extends/retracts deadbolt Inside lever simultaneously retracts latchbolt and deadbolt 	F33

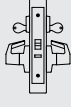
PDQ Functions – Keyed

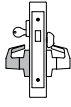
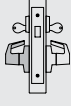
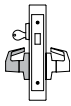
FUNCTION	FUNCTION NUMBER	OUTSIDE INSIDE	DESCRIPTION	ANSI NUMBER
Apartment/ Corridor	MR162		<ul style="list-style-type: none"> • Latchbolt operated by lever from either side • Toggle locks/unlocks outside lever • Key outside retracts latchbolt • Key outside extends/retracts deadbolt • Thumbturn inside extends/retracts deadbolt • Inside lever simultaneously retracts latchbolt and deadbolt • Auxiliary latch deadlocks latchbolt 	F20
Office	MR181		<ul style="list-style-type: none"> • Latchbolt operated by lever from either side • Key outside locks/unlocks outside lever • Thumbturn inside locks/unlocks outside lever • Closing door unlocks outside lever • Rotating inside lever unlocks outside lever • Auxiliary latch deadlocks latchbolt 	—
Apartment	MR186		<ul style="list-style-type: none"> • Latchbolt operated by lever from either side • Key inside locks/unlocks outside lever • Key outside retracts latchbolt • Auxiliary latch deadlocks latchbolt • Not Field Reversible 	F09
Electrified Storeroom	 MR199A		<ul style="list-style-type: none"> • Key outside retracts latchbolt • Latchbolt operated by lever from inside • Auxiliary latch deadlocks latchbolt • Fail safe – latchbolt operated by lever from outside unless electrically locked • Fail secure – latchbolt operated by lever from outside when electrically unlocked • Motor drive locking/unlocking • Not field reversible • Specify handing <p> • Available with option: REX - Request to Exit</p>	—
Electrified Institutional	 MR200		<ul style="list-style-type: none"> • Key outside retracts latchbolt • Key inside retracts latchbolt • Auxiliary latch deadlocks latchbolt • Fail safe – latchbolt operated by either lever when electrically locked • Fail secure – latchbolt operated by either lever when electrically unlocked • Motor drive locking/unlocking • Not field reversible • Specify handing <p> • Available with option: REX - Request to Exit</p>	—
Cylinder and Thumbturn Deadbolt with Dummy Trim	MR213		<ul style="list-style-type: none"> • Key outside extends/retracts deadbolt • Thumbturn inside extends/retracts deadbolt • Rigid outside lever • Rotating inside lever retracts deadbolt 	—
Double Cylinder Deadbolt with Dummy Trim	MR214		<ul style="list-style-type: none"> • Key outside extends/retracts deadbolt • Key inside extends/retracts deadbolt • Rigid outside lever • Rotating inside lever retracts deadbolt 	—
Single Cylinder Deadbolt with Dummy Trim	MR215		<ul style="list-style-type: none"> • Key outside extends/retracts deadbolt • Rigid outside lever • Rotating inside lever retracts deadbolt 	—

MR SERIES

LIST PRICE

Effective July 3, 2023

PDQ Indicator Functions

- Locked/Unlocked Indicator conforms with ANSI Z535.1 Safety Colors: Red and Green.









Shown with optional Security Screws. For more information, contact PDQ Customer Service.

FUNCTION	FUNCTION NUMBER	OUTSIDE INSIDE	DESCRIPTION	ANSI NUMBER
Dormitory/ Exit w/Indicator	MR236		<ul style="list-style-type: none"> • Latchbolt operated by lever from either side • Key outside extends/retracts deadbolt • Thumbturn inside extends/retracts deadbolt • Inside lever simultaneously retracts latchbolt and deadbolt • Auxiliary latch deadlocks latchbolt • Indicator, outside — (LOCKED/UNLOCKED) 	F13
Storeroom with Deadbolt w/Indicator	MR241		<ul style="list-style-type: none"> • Latchbolt operated by lever from inside • Key outside retracts latchbolt • Key outside extends/retracts deadbolt • Rigid outside lever • Inside lever simultaneously retracts latchbolt and deadbolt • Auxiliary latch deadlocks latchbolt • Thumbturn inside extends/contracts deadbolt but doesn't effect outside lever. • Indicator, outside — (LOCKED/UNLOCKED) 	—
Intruder Deadbolt with Deadlatch	MR257		<ul style="list-style-type: none"> • Latchbolt operated by lever from either side • Key outside extends/retracts deadbolt • Key inside extends/retracts deadbolt • Inside lever simultaneously retracts latchbolt and deadbolt • Auxiliary latch deadlocks latchbolt • Indicator, inside — (LOCKED/UNLOCKED) 	F34 w/Indicator
Intruder Deadbolt	MR259		<ul style="list-style-type: none"> • Latchbolt operated by lever from either side • Key outside extends/retracts deadbolt • Key inside extends/retracts deadbolt • Inside lever simultaneously retracts latchbolt and deadbolt • Indicator, inside — (VACANT/OCCUPIED) 	F33 w/Indicator
Faculty Restroom with Deadbolt w/Indicator	MR260		<ul style="list-style-type: none"> • Latchbolt retracted by key outside or lever inside • Key outside extends/retracts deadbolt • Rigid outside lever • Thumbturn inside extends/retracts deadbolt • Rotating inside lever retracts deadbolt and latchbolt simultaneously • Inside lever is always free for immediate egress • Indicator, outside — (VACANT/OCCUPIED) 	—
Privacy w/Indicator	MR 269		<ul style="list-style-type: none"> • Latchbolt operated by lever from either side • Key outside extends/retracts deadbolt • Thumbturn inside extends/retracts deadbolt • Inside lever simultaneously retracts latchbolt and deadbolt • Indicator, inside — (VACANT/OCCUPIED) 	
Privacy w/Indicator	MR276		<ul style="list-style-type: none"> • Latchbolt operated by lever from either side • Emergency coin turn outside unlocks outside lever • Thumbturn inside locks/unlocks outside lever • Closing door unlocks outside lever • Rotating inside lever unlocks outside lever • Indicator, outside — (VACANT/OCCUPIED) 	F22 w/Indicator
Privacy with Deadbolt w/Indicator	MR278		<ul style="list-style-type: none"> • Latchbolt operated by lever from either side • Emergency coin turn outside retracts deadbolt • Thumbturn inside extends/retracts deadbolt • Indicator, outside — (VACANT/OCCUPIED) 	F02 w/Indicator
Privacy with Deadbolt and Egress w/Indicator	MR279		<ul style="list-style-type: none"> • Latchbolt operated by lever from either side • Emergency coin turn outside retracts deadbolt • Thumbturn inside extends/retracts deadbolt • Inside lever simultaneously retracts latchbolt and deadbolt • Indicator, outside — (VACANT/OCCUPIED) 	F19 w/Indicator



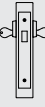

Notes: Functions MR257, MR259 and MR260 not available in 7 Pin SFIC or LFIC.



PDQ Functions – Deadlocks

FUNCTION	FUNCTION NUMBER	OUTSIDE INSIDE	DESCRIPTION	ANSI NUMBER
Single Cylinder Deadbolt	MR131		<ul style="list-style-type: none"> • Key outside extends/retracts deadbolt 	F18
Cylinder and Thumbturn Deadbolt	MR132		<ul style="list-style-type: none"> • Key outside extends/retracts deadbolt • Thumbturn inside extends/retracts deadbolt 	F17
Double Cylinder Deadbolt	MR133		<ul style="list-style-type: none"> • Key outside extends/retracts deadbolt • Key inside extends/retracts deadbolt 	F16
Classroom Deadbolt	MR134		<ul style="list-style-type: none"> • Key outside extends/retracts deadbolt • Inside cylinder turn retracts but does not extend deadbolt • Not field reversible • Specify handing 	F29
Single Cylinder Deadbolt w/Indicator (Privacy)	MR232		<ul style="list-style-type: none"> • Key outside extends/retracts deadbolt • Thumb turn inside extends/retracts deadbolt • Indicator outside displays: <ul style="list-style-type: none"> • Occupied when deadbolt is projected • Vacant when deadbolt is retracted • Indicator, outside — (VACANT/OCCUPIED) 	—

PDQ Functions – Non Keyed Dummy

FUNCTION	FUNCTION NUMBER	OUTSIDE INSIDE	DESCRIPTION	ANSI NUMBER
Double Dummy	MR205		<ul style="list-style-type: none"> • Rigid outside lever • Rigid inside lever 	—
Double Dummy with Chassis	MR206		<ul style="list-style-type: none"> • Rigid outside lever • Rigid inside lever 	—
Double Dummy with Active Trim	MR207		<ul style="list-style-type: none"> • Movable outside lever • Movable inside lever 	—
Single Dummy	MR211		<ul style="list-style-type: none"> • Rigid outside lever 	—
Single Dummy with Chassis	MR212		<ul style="list-style-type: none"> • Rigid outside lever 	—

Function Cross Reference

ANSI #	PDQ FUNCTION	ARROW	BEST	CORBIN	DORMA	FALCON	MARKS	SARGENT	SCHLAGE	YALE
DUMMY 1 SIDE	MR211	BM/AM08	45H1DT	ML2050	M9001	MA12	DI/DO	8293	L0170	AU865
DUMMY 2 SIDES	MR207	BM/AM09	45H2DT	ML2071	M9002	MA18	DT	8294	L0172	AU838A
DUMMY 1 SIDE	MR212	N/A	N/A	N/A	M9003	N/A	N/A	N/A	L9175	N/A
DUMMY 2 SIDES	MR206	N/A	N/A	N/A	M9004	N/A	N/A	N/A	L9176	N/A
F01	MR126	BM/AM01	45HN	ML2071	M9010	MA101	5N	8215	L9010	AU8801FL
F31	SEE TJ SE-RIES	BM/AM07	45HNX	N/A	M9025	MA161	5EX	N/A	N/A	AU8828
F22	MR176	BM/AM26	45HLT	ML2060	M9040	MA321	5LJ	8265	L9040	AU8862FL
F04	MR116	BM/AM22	45HA	ML2051	M9050	MA521	5E	8205	L9050	AU8807FL
F09	MR186	BM/AM32	45HC	ML2042	M9060	MA381	5G	8216	L9060	AU8817-2FL
F05	MR148	BM/AM17	45HR	ML2055	M9070	MA561	5J	8237	L9070	AU8808FL
F06	MR113	N/A	45HR/HB	ML2056	M9076	MA551	5JM/JR	8289	L9076	AU8800
F07	MR115	BM/AM12	45HD	ML2057	M9080	MA581	5EW	8204	L9080	AU8805FL
	MR199A	BM/AM17/177	45HEL	ML22901	M9080EL	MA851	5EL	8270	L9080EL	AU8890FL
	MR199A	BM/AM17/178	45HEU	ML22904	M9080EU	MA881	5EU	8270	L9080EU	AU8891FL
	MR199A W/ REX	N/A	45HEURQE	ML22901 M92	M9080ELRX	N/A	5EL W10	RX-8272	L9080ELRX	AU8890FL-REX
	MR199A W/ REX	N/A	45HEURQE	ML22904 M92	M9080ELRX	N/A	5EU W10	RX-8273	L9080EU-RX	AU8891FL-REX
F30	MR138	BM/AM33	45HW	ML2032	M9082	MA411	5WW	N/A	L9082	AU8830-2FL
F19	MR179	BM/AM02	45HL	ML2030	M9940	MA311	5LF	8266	L9440	AU8802FL
F20	MR162	BM/AM20	45HAB	ML2067	M9953	MA531	5FD	8243	L9453	AU8847FL
F13	MR136	BM/AM19	45HT	ML2065	M9956	MA571	5FW	8225	L9456	AU8822FL
F11	MR158	N/A	N/A	N/A	M9957	N/A	5FA	N/A	N/A	AU8800
F17	MR132	BM41	45HAD	ML2013	N/A	M941	5P	8221	L9460	AU8815
F18	MR131	BM40	45HYB	NML2011	N/A	MA921	5S	8220	L9464	AU8814
F16	MR133	BM42	45HWD	ML2012	N/A	M931	5T	8222	L9462	AU8814-2
F29	MR134	BM44	45HRD	ML2017	MB9963	M911	5SC	8203	L9463	AU8813ST
F14	MR137	BM/A/31	45HG	ML2017	M9966	MA371	5C	8226	L9466	AU8860-2FL
F34	MR157	N/A	45HIDA	ML2023	M9967	MA431	5FC	8240	N/A	AU8812-2FL
F33	MR159	N/A	45HIND	N/A	M9968	N/A	5FX	N/A	L9457	AU8811-2FL
F21	MR135	BM/AM13	45HB	ML2024	M9973	MA541	5B	8224	L9473	AU8860FL
F02	MR178	N/A	N/A	ML2020	N/A	MA301	5-55L	8268	N/A	N/A

Lever Cross Reference

LEVER AND KNOB OPTIONS	PDQ	ARROW	BEST	CORBIN	DORMA	FALCON	MARKS	SARGENT	SCHLAGE	YALE
LEVER	PHILADELPHIA	X	15	NS NEWPORT	LR	D DANE	AMERICAN LEVER 92	L	06 RHODES	AU AUGUSTA
	BOSTON	BR	14	PS PRINCETON	LC	Q QUANTUM	CRESCENT LEVER 86	P	17SPARTA	PB PACIFIC BEACH
	CHICAGO	N	12	REGIS	LIIO	N/A	OMNI 78	W	02	PINEHURST PNR
	DALLAS	HS	3	LS LUSTR	LT	K KIM	PLAZA LEVER 82	J	03TUBULAR	CR CARMEL
	HOUSTON	N/A	79	25M PIET	N/A	N/A	N/A	REM	M51	N/A
	MIAMI	V	16	AS ARMSTONG	LG	A AVALON	TITAN LEVER 96	B	07ATHENS	JN JEFFERSON
	MEMPHIS	W	69	DIRKE	LD	N/A	DAYTON 83	A	12	VICTORIA TT
	LOS ANGELES	N/A	N/A	N/A	N/A	N/A	N/A	N/A	N/A	N/A
	ORLANDO	N/A	N/A	N/A	N/A	N/A	N/A	N/A	LATITUDE	N/A
KNOB	KNOB	HB	4	YW	KB	T TROY	ROUND KNOB 10	C	41 PLYMOUTH	LF LITCHFIELD
	B	HT	N/A	GR	KB	H HANA	ROUND KNOB 10	B	42 ORBIT	CA CAROLINA
	N/A	A	R	F	KB	G GALA	RW	N/A	B	R

Information on this sheet is compiled from public documents and third parties. As a result, PDQ makes no guarantees as to their accuracy, content, quality or availability. Comparisons were made using the technical features only and are not commercial comparisons. Final suitability should be determined by a professional hardware consultant.



MR SERIES

LIST PRICE

Effective July 3, 2023

F Series Sectional Trim

- Levers: Solid Forged Brass
- Trim: Wrought

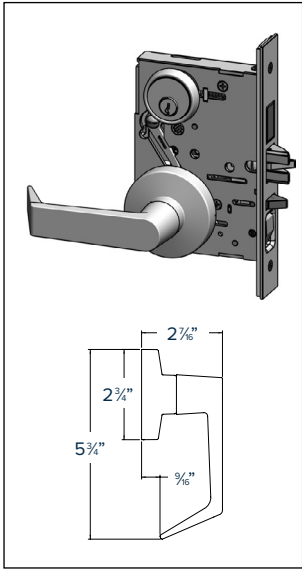

PHILADELPHIA — PFSF

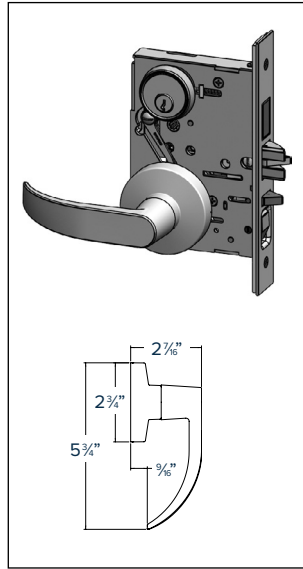

BOSTON — BFSF

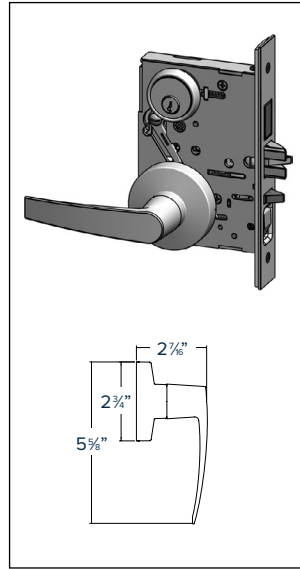

MIAMI — MFSF

F Series Escutcheon Trim

- Levers: Solid Forged Brass
- Trim: Forged Brass

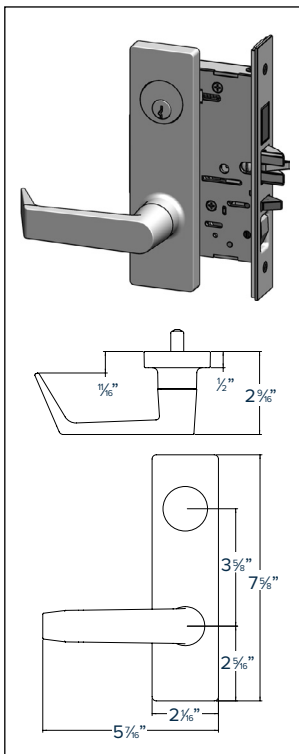

PHILADELPHIA — PFEF

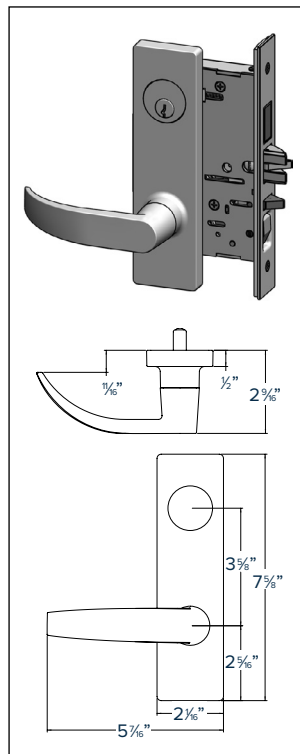

BOSTON — BFEF

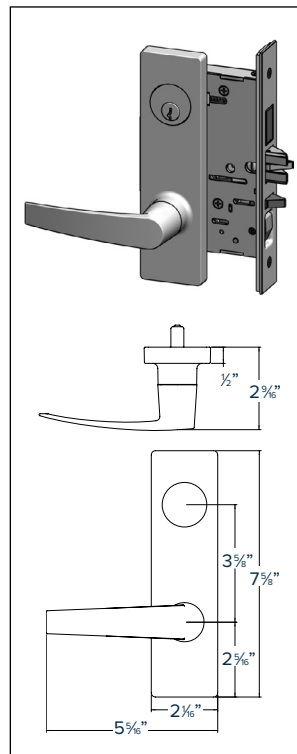

MIAMI — MFEF

 ALL LEVERS

*Knobs are not ADA Compliant

J Series Sectional Trim with Round Rose

- Levers: Philadelphia, Boston, Miami, Memphis, Houston – Solid Levers
Chicago, Dallas, Los Angeles, Orlando – Hollow Tube Levers
- Trim: Wrought

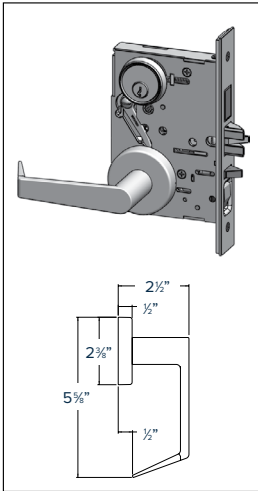

PHILADELPHIA —
PJSJ

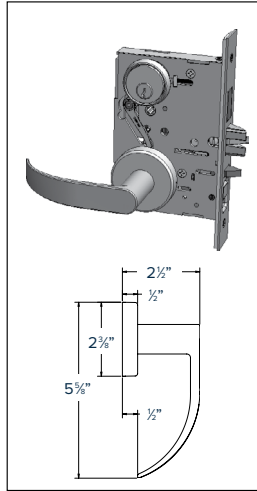

BOSTON — BJSJ

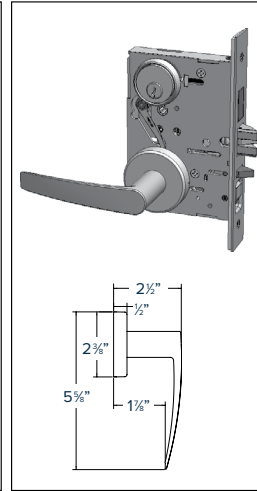

MIAMI — MJSJ

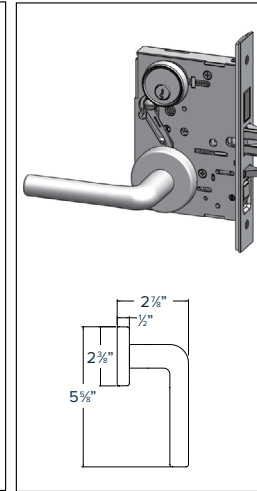

CHICAGO — CJSJ

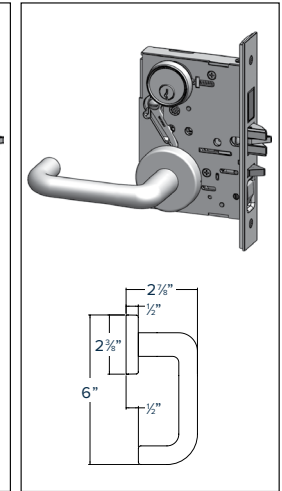

DALLAS — DJSJ

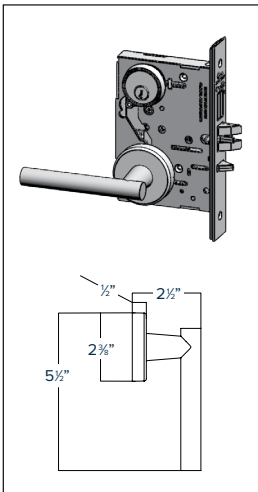

HOUSTON — HJSJ

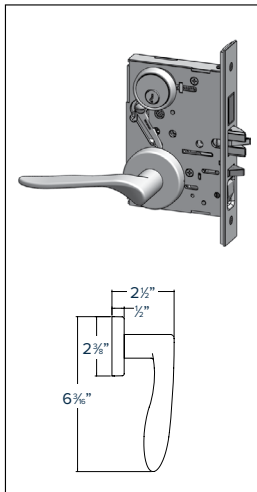

MEMPHIS — TJSJ

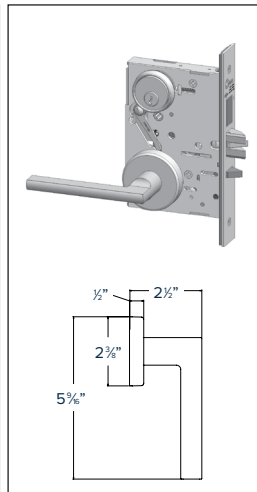

ORLANDO — OJSJ

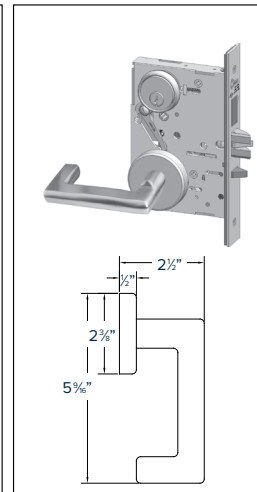

LOS ANGELES —
LJSJ

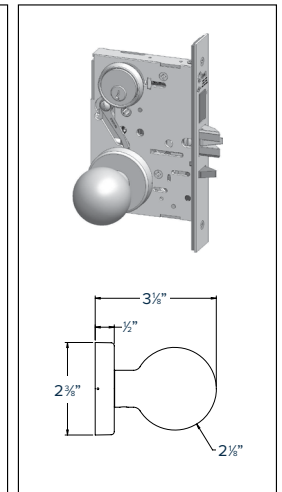

BALL KNOB — KJSJ



*Knobs are not ADA Compliant

MR SERIES

LIST PRICE

Effective July 3, 2023

J Series Sectional Trim with Square Rose

- Levers: Philadelphia, Boston, Miami, Memphis, Houston – Solid Levers
Chicago, Dallas, Los Angeles, Orlando – Hollow Tube Levers
- Trim: Wrought

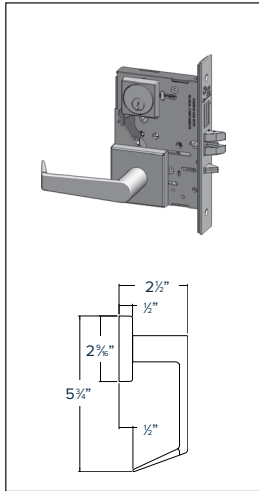

PHILADELPHIA —
PJSR

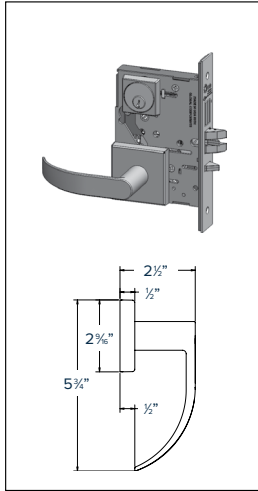

BOSTON — BJSR

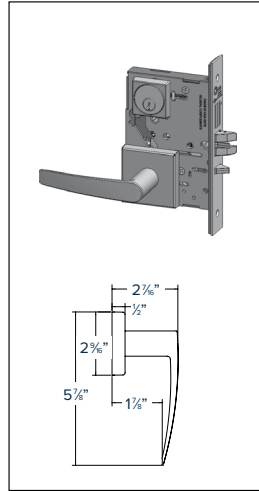

MIAMI — MJSR

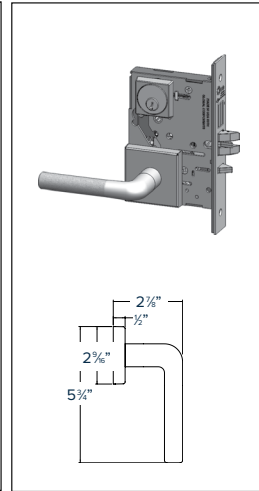

CHICAGO — CJSR

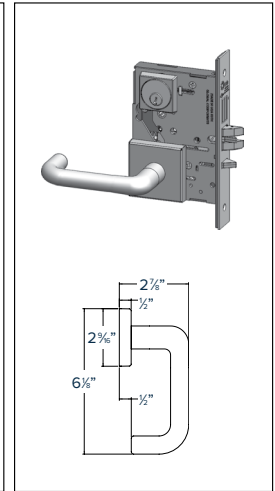

DALLAS — DJSR

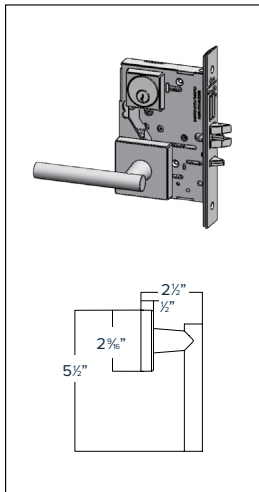

HOUSTON — HJSR

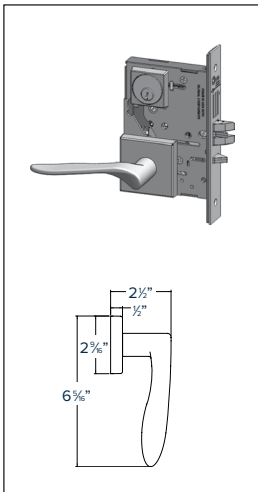

MEMPHIS — TJSR

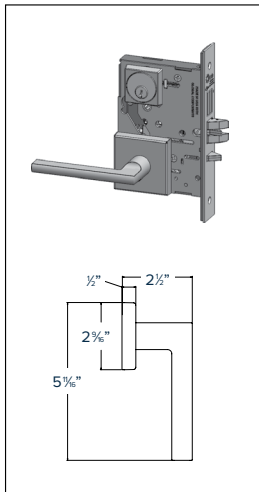

ORLANDO — OJSR

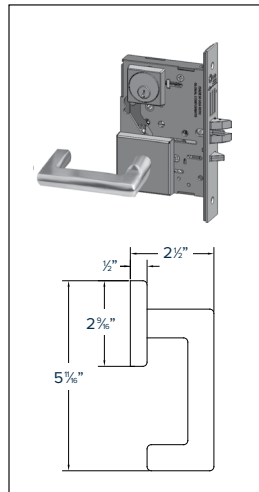

LOS ANGELES —
LJSR

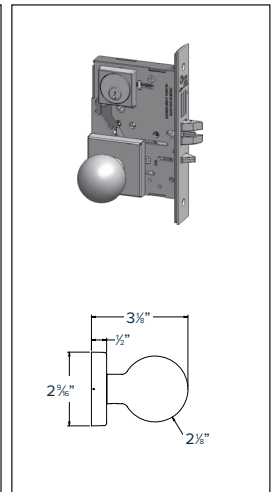

BALL KNOB — KJSJ

ALL LEVERS

*Knobs are not ADA Compliant

J Series Escutcheon Trim

- Levers: Philadelphia, Boston, Miami, Memphis, Houston – Solid Levers
Chicago, Dallas, Los Angeles, Orlando – Hollow Tube Levers
- Trim: Investment Cast Stainless

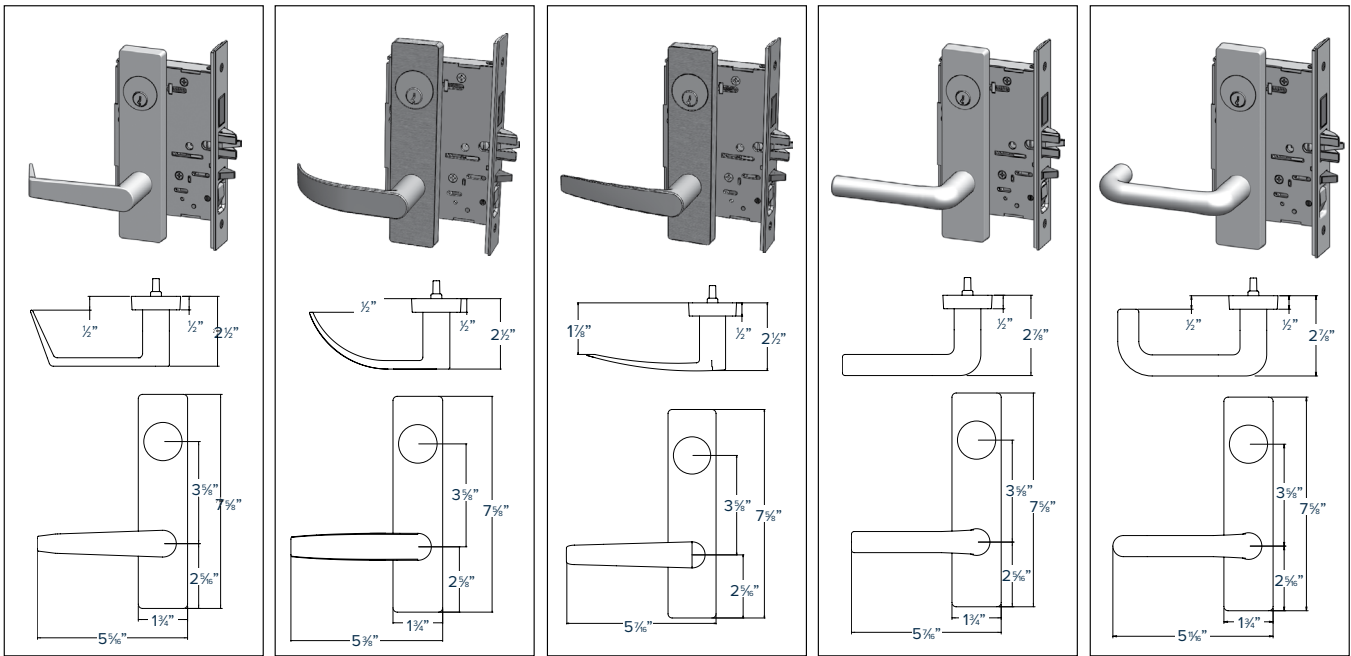

PHILADELPHIA — PJEJ

BOSTON — BJEJ

MIAMI — MJEJ

CHICAGO — CJEJ

DALLAS — DJEJ

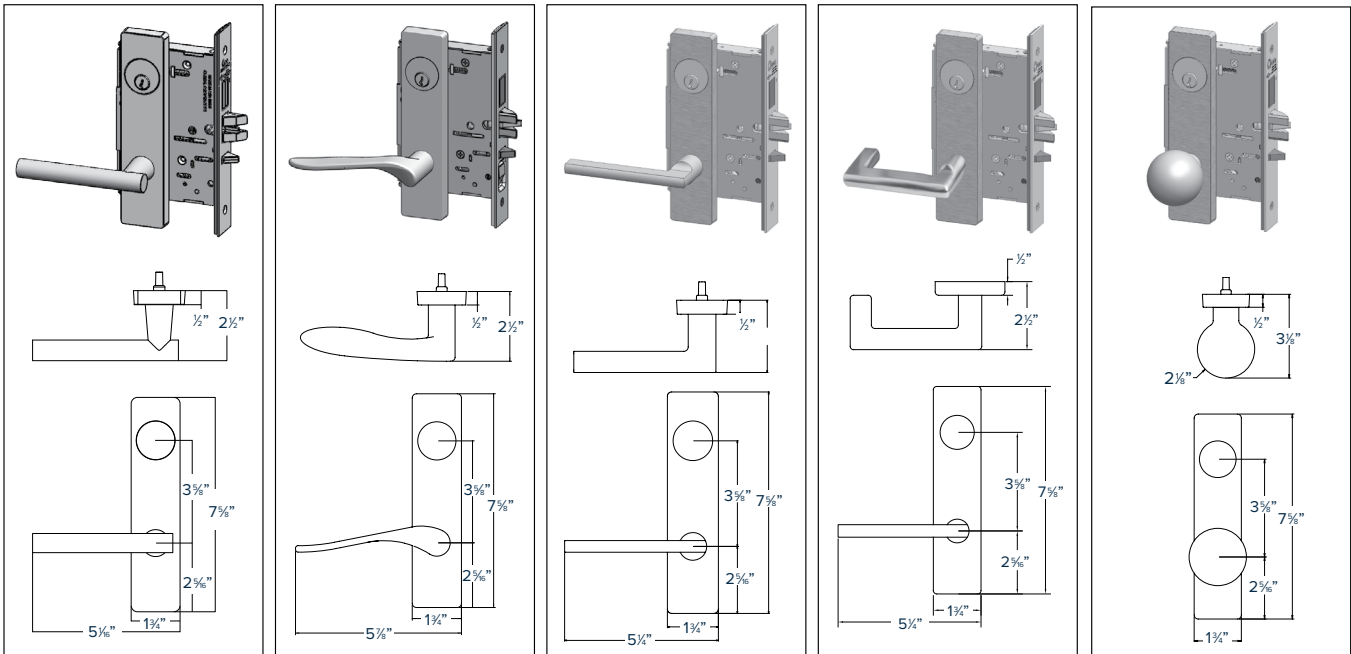

HOUSTON — HJEJ

MEMPHIS — TJEJ

ORLANDO — OJEJ

LOS ANGELES — LJEJ

BALL KNOB — KJEJ



*Knobs are not ADA Compliant

J Series Wide Escutcheon Trim

- Levers: Philadelphia, Boston, Miami, Memphis, Houston – Solid Levers
- Chicago, Dallas, Los Angeles, Orlando – Hollow Tube Levers
- Trim: Investment Cast Stainless

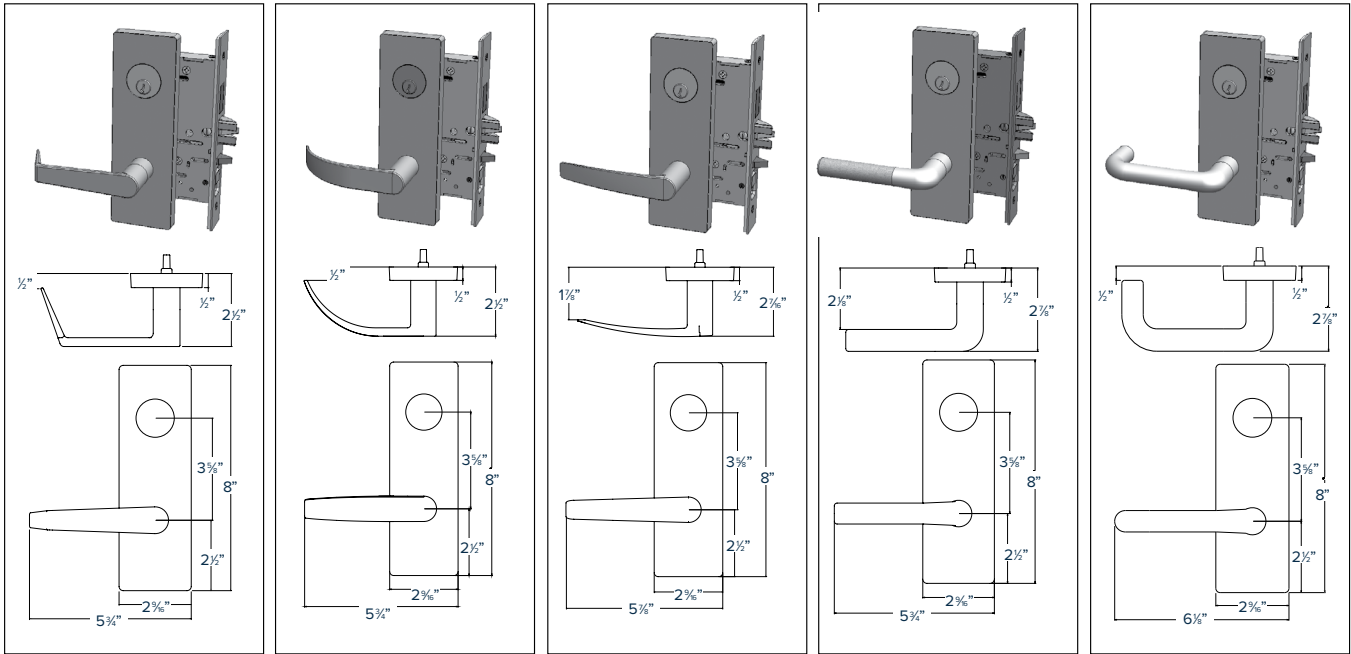

PHILADELPHIA —
PJEW

BOSTON — BJEW

MIAMI — MJEW

CHICAGO — CJEW

DALLAS — DJEW

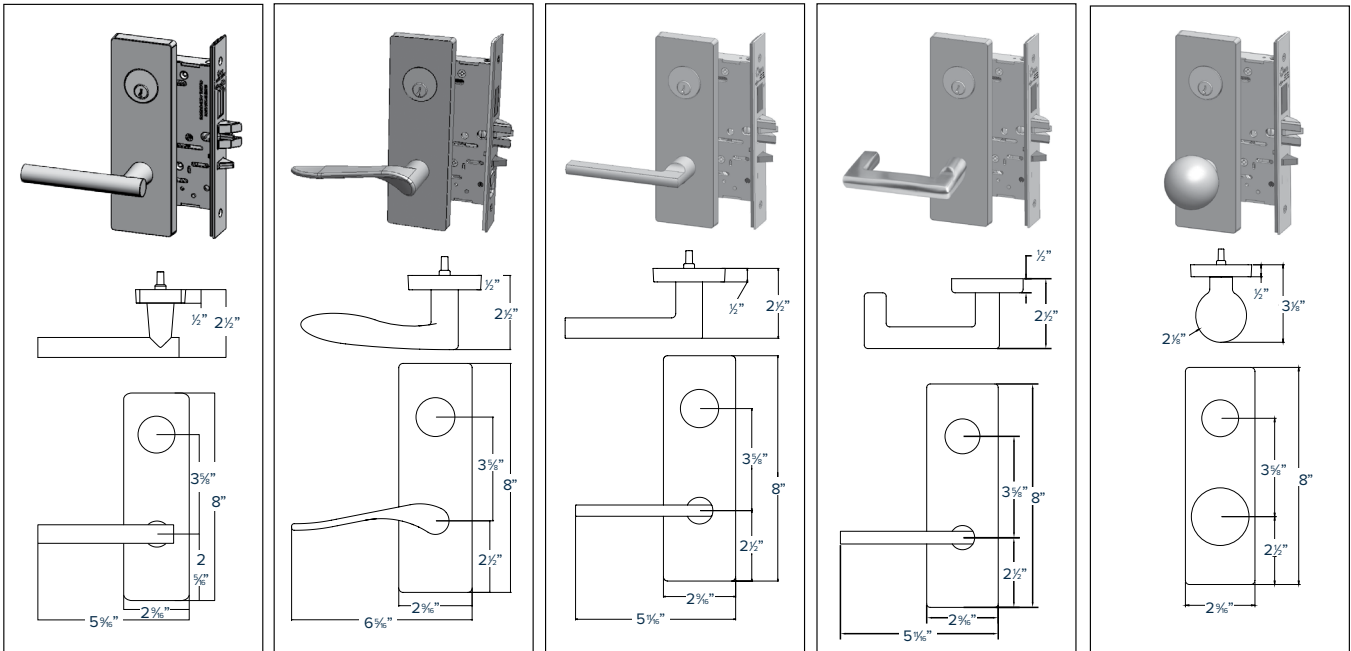

HOUSTON — HJEW

MEMPHIS — TJEW

ORLANDO — OJEW)

LOS ANGELES —
LJEW

BALL KNOB — KJEW



*Knobs are not ADA Compliant

Typical Applications

- High-End Residential
- Multi-family
- Offices

Features

- Contemporary decorative trim perfect for high end residential and office work
- Designed to compliment MR Series Mortise locks sharing the same sectional rose diameter and levers
- Investment cast stainless steel trim
- Range of lever styles available
- Available in round rose or square rose
- Uses a slender 2-3/8" diameter rose providing a clean contemporary look

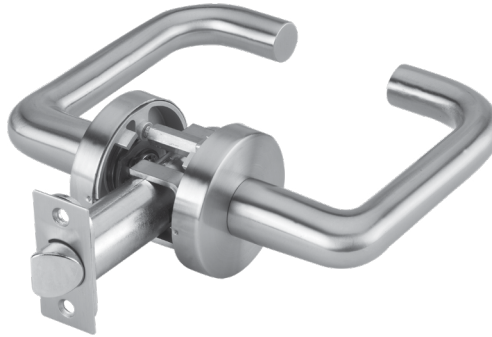

Round Rose Trim
with Dallas Lever



Square Rose Trim
with Orlando Lever

Specifications



FOR DOORS:	• For doors 1-3/8" (35mm) to 1-3/4" (44mm) thick standard
BACKSET:	• 2-3/4" (70mm) default. Optional: 2-3/8" (60mm);
STRIKE:	• "Full Lip" strike default. "T" strike and ASA strike optional
ROSE DIMENSIONS:	• Round Rose: 2-3/8" DIA • Square Rose: 2-9/16"
DOOR PREP:	• ANSI Standard 115.2, Type 161 for 2-3/4" Backset • Type 160 optional
LATCH BOLTS:	• 2-3/4" Backset has 1-1/8" faceplate. 2-3/8" Backset has a 1" faceplate filler
HAND:	• Non-handed, except Memphis. (Orlando, Los Angeles, Houston is handed for 211 function only)
FINISHES:	• 605 (US3) Bright Brass, 606 (US4) Satin Brass, 612 (US10) Satin Bronze, 613E Dark Oxidized Satin Bronze, 622 (US19) Flat Black, 629 (US32) Bright Stainless Steel, 630 (US32D) Satin Stainless Steel
TRIM:	• Stainless Steel Levers and Roses
LEVER DESIGNS:	• Philadelphia, Boston, Miami, Chicago, Houston, Memphis, Orlando, Los Angeles, Dallas and Ball Knob.
CERTIFICATIONS, LISTINGS, COMPLIANCES:	• Complies with ADA (Americans with Disabilities Act) and ICC/ANSI 117.1 for Accessible and Usable Buildings (except ball knob).
WARRANTY:	• Five (5) year limited warranty

How to Order

TJ SERIES
TUBULAR LOCKS

QUANTITY	SERIES	FUNCTION	LEVER	ROSE	FINISH	BACKSET	HANDING	STRIKE
5	TJ	176	PHL	—	630	234	—	FL
			PHL	BLANK – Round Rose (Default) SR – Square Rose	605	234 – 2-3/4" Default 238 – 2-3/8" Optional	LH – Left Hand RH – Right Hand	FL – Full Lip Strike (Default) T – 'T' Strike ASA – ANSI/ASA Strike
			BSN		606			
			MIA		612			
			CHI		613E			
			DAL		622			
			MEM		629			
			ORL		630			
			HOU					
			LAX					
			KJ					

TJ Series

ANSI NO.	FUNCTION	DESCRIPTION	SECTIONAL	
			630	605, 606, 612 613E, 622, 629
	125	Communicating	\$130.00	\$155.00
F75	126	Passage	\$180.00	\$205.00
F76	176	Privacy	\$180.00	\$205.00
	205	Double Dummy	\$130.00	\$155.00
	211	Single Dummy	\$100.00	\$112.00

Rose Option

CODE	DESCRIPTION	LOCK ADJUSTMENT
—	Round Rose	N/C
SR	Square Rose	\$10.00

Lever / Round Rose



PHILADELPHIA — PHL

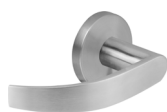

BOSTON — BSN



MIAMI — MIA



CHICAGO — CHI



DALLAS — DAL



MEMPHIS — MEM
 (Specify handing)



ORLANDO — ORL
 (Specify handing)



LOS ANGELES — LAX
 (Specify handing)



HOUSTON — HOU
 (Specify handing)



BALL KNOB — KJ



ALL LEVERS

Lever / Square Rose



PHILADELPHIA — PHL



BOSTON — BSN



MIAMI — MIA



CHICAGO — CHI



DALLAS — DAL



MEMPHIS — MEM
☞ (Specify handing)



ORLANDO — ORL
☞ (Specify handing)



LOS ANGELES — LAX
☞ (Specify handing)



HOUSTON — HOU
☞ (Specify handing)





BALL KNOB — KJ

ALL LEVERS

PDQ Functions

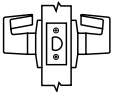
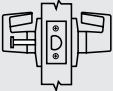
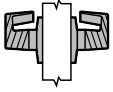
TJ SERIES
TUBULAR LOCKS

FUNCTION	FUNCTION NUMBER	INSIDE OUTSIDE	DESCRIPTION	ANSI NUMBER
NON KEYED				
Communicating	125		<ul style="list-style-type: none"> Latchbolt operated by lever from inside Non removable blank outside 	—
Passage Closet	126		<ul style="list-style-type: none"> Latchbolt operated by lever from either side 	F75
Privacy Bedroom/Bathroom	176		<ul style="list-style-type: none"> Latchbolt operated by lever from either side Outside lever locked by push button on inside Outside lever unlocked by emergency release from outside, rotating inside lever, or closing door 	F76
Double Dummy	205		<ul style="list-style-type: none"> Rigid lever both sides No mechanical operation 	—
Single Dummy	211		<ul style="list-style-type: none"> Rigid lever outside No mechanical operation 	—



INDICATES RIGID LEVER



Heavy Duty Grade 1 Cylindrical Locks



ASSEMBLED
IN THE USA

More Duty Than You Can Handle

Most manufacturers' approach to lock design ends with simply meeting BHMA/ANSI standards but not PDQ. Our philosophy is to step out of the box and develop innovative designs that take our locks to the next level. We don't just meet the standard, we crush it. Our design doctrine delivers the confidence that locks are built to last, whether the application calls for resistance to high abuse or to millions of cycles of operation without any degradation in performance

XGT/GT Mechanical

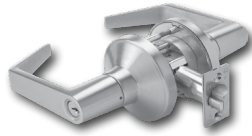

Applications

High traffic doors, areas subject to severe abuse, K-12, higher education, Healthcare, public buildings and retro-fit applications.

XGT/GT199A Electro-Mechanical

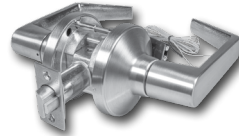

Applications

Stairwell towers, tenant spaces, pharmacies, computer rooms and high security areas.

XGT/GT135LED School Security Solution



Applications

In K-12 and higher education, indicators are part of the overall security plan. The GT135LED Classroom Intruder lock is designed to allow a staff member to use the inside cylinder to lock the outside of the door. The Intruder function eliminates the need to open the door to check for a locked lever. Simply press the button on the lock and if the red LED lights up the outside lever in locked and secure. If the LED does not light up, the outside lever is unlocked.

SX Ball Knob

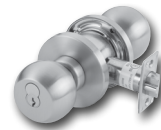

Applications

High traffic areas, Healthcare and commercial buildings.



XGT/ GT199A

Electrified Cylindrical Lock Grade 1 Heavy Duty



ASSEMBLED
IN THE USA

Typical Applications

- Computer Rooms
- High Security Areas
- Pharmacies
- Stairwell Towers
- Tenant Spaces

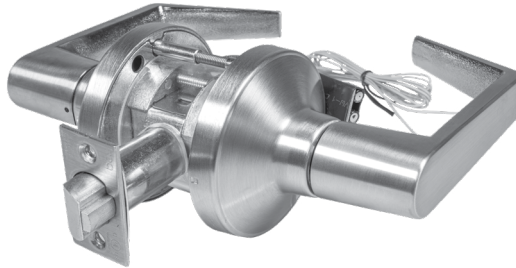

Specifications



PERFORMANCE:	<ul style="list-style-type: none"> • Motor drive factory tested to over 1.4 million cycles (nearly 3x the ANSI/BHMA Grade 1 Standard).
RECOMMENDED POWER SUPPLY:	<ul style="list-style-type: none"> • PDQ Model # PS220. <ul style="list-style-type: none"> – Input: 110-120 VAC 60Hz – Output: 24VDC, 2A, filtered and regulated. • Rated for simultaneous operation of 2ea mortise lock assemblies. • Power Supply Requirements: <ul style="list-style-type: none"> – AC/DC Output Voltage – 1A min (filtered and regulated).
ELECTRICAL SPECIFICATIONS:	<ul style="list-style-type: none"> • Input voltage: 12-24VDC or 12-24VAC. • Max In-rush current: 1.0A. • Standby current: <ul style="list-style-type: none"> – 12VAC: 12mA. – 24VAC: 10mA. – 12VDC: 3mA. – 24VDC: 5mA. • 12-24VDC @ < 1A initial surge (1 sec), 5mA standby after 30 sec. <ul style="list-style-type: none"> – AC Output Voltage. • 12-24VAC (60Hz) @ < 1A initial surge (1 sec), 15mA standby after 30 sec <p>Note: Operating voltage at ± 10% of rated voltage.</p>
CERTIFICATIONS, LISTINGS, COMPLIANCES:	<ul style="list-style-type: none"> • ANSI/UL10C and CAN/ULC-5104 Listed for "Fire Exit Hardware" up to 3 hours for 4'0" x 8'0" maximum single, 8'0" x 8'0" maximum pairs. • Assembled in the U.S.A. with U.S. and foreign material. Meets requirements of the Buy American Act as a COTS product manufactured in the United States.
WARRANTY:	<ul style="list-style-type: none"> • 25-Years Mechanical / 2-Years Electronic

Trim/Levers



PHILADELPHIA — PHL



SFL



LFL



BOSTON — BSN



SFL



MIAMI — MIA



SFL



ASSEMBLED
IN THE USA



Outside Lever Unlocked



To Check the Security of the Outside Lever, Press the Button. If the Red Led Lights Up, that Confirms the Outside Lever is Locked and Secure.

Easy-to-Read LED Indicator Confirms the Door is Locked.

XGT/GT 135 LED Classroom Intruder Cylindrical Lock is designed to allow a staff member to use the inside cylinder to lock the outside of the door, without compromising safety to the occupants in the room. But how does a staff member know if the outside lever is locked?



Until now, it required opening the door and checking the lever. PDQ's 135 LED Classroom Intruder function eliminates the need to open the door. Simply press the button on the lock, and...if the Red LED lights up, the outside lever is locked and secure. If the Red LED does not light up, this indicates the outside lever is not locked and secure.

Features



- Complies with California Education Code (Functions GT135, GT135LED, GT145)
- Red LED (Light Emitting Diode) outside lever status indicator.
- Pushing the button located on the rose of the inside lock, Red LED illuminates indicating the outside lever is locked.
- Offered with cylinder housings compatible with Best® Small Format Inter-changeable cores, Schlage® Large Format Interchangeable cores and most others.
- Large Format Inter-changeable cores only available with PHL lever.
- Keying options available, compatible with most key systems.
- Battery life rating: 10 years*
- Battery type: CR1220
- Patented (US Patent #9,187,928)
- Factory tested to over 2 million cycles (2 times the ANSI/BHMA Grade 1 std)
- Lever torque tested to 2,100 in-lbs (3 times the ANSI/BHMA Grade 1 std)

Status Indicator Locks

GT135LED
GT135
GT145

Time Out Locks

GT173

School Security Functions

Vestibule Class Room Security with LED Status Indicator

Vestibule Class Room Security without LED Status Indicator

Vestibule Class Room Security with Lock Directional Arrow (No LED Indicator)

Time Out Lock



ASSEMBLED
IN THE USA

Typical Applications

- Federal and State Government
- Healthcare
- Higher Education
- Hospitality
- Houses of Worship
- Industrial
- K-12 Education
- Offices
- Public Buildings

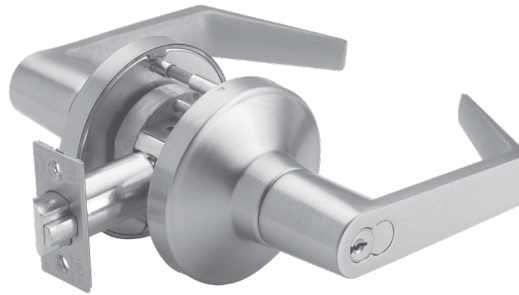

Specifications



ADA COMPLIANT



FOR DOORS:	• 1-3/4" to 2-1/4" thick • Preset for 1-3/4" door
APPLICATION:	• Through door thru-bolting
DOOR PREP:	• Standard ANSI A156.115 (161) for Cylindrical Locks
BACKSET:	• 2-3/4" Standard. 2-3/8", 2-3/4"FF, 3-3/4" and 5" Optional (Ordered from factory only). • Heavy duty diecast, investment cast, chromated cold rolled steel and stainless steel mechanism. • Billet Steel spindles for locking functions
FRONT:	• 2-1/4" x 1-1/8" • Stainless Steel or Wrought Brass • Beveled 1/8" in 2"
STRIKE	• ASA standard • T-Strike or Full Lip Strike optional • Stainless Steel or Wrought Brass
LEVERS:	• Philadelphia (SFL and LFL), Boston (SFL), Miami (SFL)
ROSE:	• 3-3/8" DIA Wrought
LATCHBOLT:	• 9/16" Throw Deadlocking • 3/4" Latch projection for available as option.
HAND:	• Non-handed
TRIM:	• Solid diecast PHL, BSN or MIA Levers • 41° Lever Rotation Standard with 2-3/4" Backset • Wrought Brass Roses, Concealed Screws • 65° Lever Rotation Standard with 3/4" latch for double doors (Ordered from factory only) and all 2-3/8", 3-3/4" and 5" Backsets (Ordered from factory only)
KEYS:	• Two (2) per Lock
KEYWAYS	• SCC standard (Schlage C Compatible) • Also available in keyways of other manufacturers
INTERCHANGEABLE CORE:	• Available for all keyed functions • 6 or 7-pin • Large Format IC Core available for PHL Lever ONLY. • Compatible with Best, Falcon and Arrow small format IC cores
CYLINDER:	• 6-pin Brass Insert Cylinder keyed to 5-pins • Standard High Security and UL437 Cylinders Available
KEYING:	• Options: MK, CMK or GMK • Zero Bitted (KO), Keyed Different (KD) or Keyed Alike (KA) Can be keyed into existing master key systems
FINISHES:	• 605 (US3), 606 (US4), 612 (US10), 613E , 619 (US15), 622 (US19), 625 (US26), 626 (US26D) • Optional Antimicrobial Coating 626 (USD26D) only†
CERTIFICATIONS, LISTINGS, COMPLIANCES:	• UL listed for 3 hrs, for single doors up to 4'0" x 8'0". • Optional 3/4" (19mm) throw deadlocking fire latch (FRL) available for pairs of doors • Certified to ANSI/BHMA A156.2, Grade 1 • California Education Code Compliant (Functions XGT135, XGT135LED, XGT145) • Federal Specification FF-H-10C (Superseded by A156.2) • Approved for Florida HVHZ (High Velocity Hurricane Zone). PDQ Product Approval: FL 21376. • Design load rating: ± 70.0 PSF for single door (3' x 7') • Complies with ADA (Americans with Disabilities Act) and ICC/ANSI 117.1 for Accessible and Usable Buildings
WARRANTY:	• Limited Lifetime Warranty
COUNTRY OF ORIGIN:	• Proudly Assembled in the U.S.A. with U.S. and foreign material. Meets requirements of the Buy American Act as a COTS product manufactured in the United States.

† Available with antimicrobial powder coating, treated with silver ionic technology that is known to inhibit the growth of microbes.

XGT SERIES

LIST PRICE

Effective July 3, 2023

How to Order

QUANTITY	SERIES	FUNCTION	LEVER	FINISH	BACKSET	STRIKE	CYLINDER	KEYWAY	KEYING	OPTION
6	XGT	116	PHL	626	234	ASA	D	SCC	KD	—
			BSN	605	234 — 2-3/4"	ASA — ASA (default)	D Default	PAGE 39		TC1IS — Tactile Abrasive Coating - Inside only
			MIA	606	(default)	ASA (default)	L Less Cylinder			TC1OS — Tactile Abrasive Coating - Outside only
			PHL	612	238 — 2-3/8"	FL — Full Lip	SF6 Lock is SFIC prepped w/ 6 pin core			TC2 — Tactile Abrasive Coating - Both Sides
				613E	334F — 3-3/4x1"	T — "T" Strike	SF7 Lock is SFIC prepped w/ 7 pin core			SF — Split Finishes
				619	334 — 3-3/4"		SFL Lock is SFIC prepped but less core			LL — Lead-Lined Rose
				622	5 — 5"		SFC Lock is SFIC prepped w/ construction core			DB — Dust Box
				625			SFP Lock is SFIC prepped w/ plastic construction core			AM — Antimicrobial Coating
				626			LF6 Lock is Schlage LFIC prepped w/ Schlage core			REX — Request to Exit
							LFL Lock is Schlage LFIC prepped but less core			
							LFC Lock is Schlage LFIC prepped w/ construction core			
							PAGE 38			PAGE 40

NOTE: Case quantity is 6 / Case weight is 33 lbs. Keyed Functions/ Case weight is 31 lbs. Non-Keyed Functions / For split finishes, designate O/S trim first, then I/S

XGT SERIES
CYLINDRICAL LOCKS

ANSI NO.	FUNCTION	DESCRIPTION	626	605/606/612 613E/619/622/625
NON-CYLINDER				
F89	124	Exit		
	125	Communicating	\$373.00	\$395.00
F75	126	Passage		
	173	Time Out		
	175	Hospital / Privacy		
F76	176	Privacy	\$420.00	\$442.00
F77	177	Patio / Privacy		
	205	Double Dummy	\$257.00	\$279.00
	211	Single Dummy	\$175.00	\$186.00
SINGLE CYLINDER				
F86	115	Store Room		
F109	116	Entrance		
F84	148	Classroom	\$484.00	\$506.00
	150	Exit / Twin Communicating		
F82	182	Office / Entry		
	120	Security	\$504.00	\$526.00
	129	Exit / Twin Communicating		
F92	155	Service Station	\$544.00	\$566.00
F90	165	Dormitory / Corridor		
DOUBLE CYLINDER				
F87	128	Institution	\$554.00	\$576.00
F110	135	Classroom / Security		
F110	135LED	Classroom/Security w/Red LED Outside Lever Status Indicator	\$723.00	\$745.00
F110	145	Classroom / Security w/Locking Direction Arrow		
F91	137	Store Door	\$578.00	\$600.00
F80	141	Communicating		
ELECTRIFIED				
	199A	Store Room	\$964.00	\$986.00

CYLINDER OPTIONS	ICON	LOCK ADJUSTMENT
D		
SFL		N/C
LFL*		

IC Core not included see page 39 for core options

LFIC prep only available in PHL lever and 613E, 622, 626 finish.

NOTES:

- Locks will be furnished with ASA Strike & SCC Keyway unless otherwise stated

Trim/Levers



ALL LEVERS



PHILADELPHIA — PHL

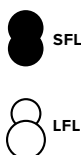

BOSTON — BSN



MIAMI — MIA



Backset

CODE	DESCRIPTION	LOCK ADJUSTMENT
2-3/4" BACKSET		
234	2-3/4" Deadlocking 2-1/4" x 1-1/8"	N/C
238	2-3/8" Deadlocking 2-1/4" x 1"	
3-3/4" BACKSET		
334F	2-1/4" x 1-1/8"	\$18
334	2-1/4" x 1"	
5" BACKSET		
5	2-1/4" x 1-1/8"	\$24
2-3/8" BACKSET		
Contact Factory for Availability		



Latchbolt

Strikes

	CODE	DESCRIPTION	LOCK ADJUSTMENT
	ASA	ASA Strike (any finish) 1-1/4" x 4-7/8"	N/C
	T	T-Strike (any finish) 1-1/8" x 2-3/4"	
	FL	Full Lip Strike (any finish) 1-5/8" x 2-1/4"	

NOTES:

- Specify finish for Strikes & Latchbolts if ordered separately

NOTES:

- Specify finish for cylinders ordered separately
- Kwikset cylinder available in 5 pin only
- Specify KD, KA4, or 1 bitted 6 pin cylinder keyed for 5 pin

Keyways and Cylinders

PDQ KEYWAY	COMPATIBLE WITH	SOLD WITH LOCK
AR1	Arrow / AR1	N/C
CO59A1	Corbin / 59A1	
CO6	Corbin / 60	
CL4	Corbin / L4	
RUD	Russwin / D1	
SCE	Schlage / E	
SCC	Schlage / C	
SCC-K	Schlage / C-K	
SAL	Sargent / LA	
RA-RC	Sargent / RA-RC	
YA8	Yale / E1R	
GA	Yale / GA	
FAL	Falcon / E-R	
KW	Kwikset	
TA	PDQ / TA (Restricted. Limited to Grandmaster systems w/4 masters)	
Dummy	—	
T-Turn	—	
L	Less Cylinder	
HIGH SECURITY CYLINDERS AND CORES		
SEE HIGH SECURITY CYLINDERS AND CORES SECTION, PAGE 118.		

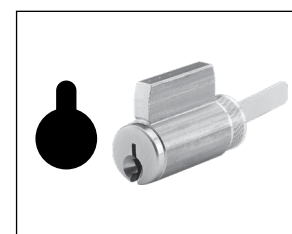

Key in Knob/Lever Cylinder



UL 437 and High Security Cylinders

Cores and Keyways

DESCRIPTION	PDQ NO.	ADD
SMALL FORMAT UNCOMBINATED		
6 Pin Cores	I5206 + KEYWAY	\$40.00
7 Pin Cores	I5207 + KEYWAY	
COMBINATED		
6 Pin Cores	I5206-1 + KEYWAY	\$60.00
7 Pin Cores	I5207-1 + KEYWAY	
BEST[™] Compatible		
A (DEFAULT), B, C, D, E, F, G, H, J, K, L, M, Q,		
WA, WB, WC, WG, WH, TB, TD, TE, & R		
PDQ Exclusive		
PDQ1, PDQ2		
PDQ Exclusive and Restricted		
PDQ3		
SFIC CONSTRUCTION		
Construction Core 6-pin only		\$60.00
Dummy Construction Core Plastic		\$8.00
LFIC CONSTRUCTION		
Construction Core 6-pin only. Construction cores are invoiced at shipment and credited upon return.		\$70.00
IC Tailpiece Assembly		\$10.00
LFIC COMBINATED		
Schlage compatible LFIC, SCC (Schlage C compatible) keyway		\$70.00
PDQ TA LFIC Restricted		
LFIC UNCOMBINATED		
Schlage compatible LFIC, SCC (Schlage C compatible) keyway		\$50.00
HIGH SECURITY IC CORES		
SEE HIGH SECURITY CYLINDERS AND CORES SECTION, PAGE 118. — LFIC REQUIRES LARGE FORMAT LEVER		

NOTES:

- Specify finish for IC Cores ordered separately
- Control keys must be ordered separately
- **PDQ1, PDQ2, PDQ3 (Restricted)**, Best A2 & A4 Systems Available

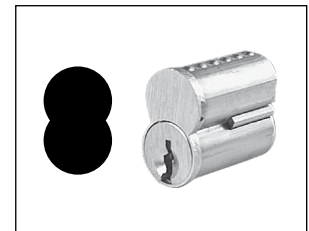

SFL/SFIC Core

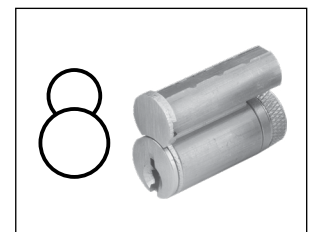

LFL/LFIC Schlage Format



UL 437 and High Security Cylinders

Options

XGT SERIES
CYLINDRICAL LOCKS

CODE	DESCRIPTION	LIST PRICE
TCIIS	Tactile Abrasive Coating - Inside only	\$26.00
TCIOS	Tactile Abrasive Coating - Outside only	
TC2	Tactile Abrasive Coating - Both Sides	\$52.00
LL	Lead-Lined Rose	\$214.00
DB	Dust Box	\$8.00
FRL	Fire Rated Latch - 3/4" Throw for double doors	\$99.00
AM	Antimicrobial Coating, Lever Set Includes Inside and Outside Lever and Rose (Not available with 605 or 625 finish)	\$37.00
REX	Request to Exit	\$122.00















Accessories

Electrified Hinges Now Available - See Hinge Section

DESCRIPTION	PDQ NO.	LIST PRICE
Electric Strike for Locks (U.L. Listed)	85001	\$650.00

XGT SERIES PARTS

LIST PRICE
Effective July 3, 2023

	DESCRIPTION	LIST PRICE	FINISHES						
			N/A	605	606	612	613E	625	626
	Push Button For Functions GT155, GT165, GT173, GT175, GT176, GT177, GT182	\$13	—	VA91302-5	VA91302-8	VA91302-3	VA91302-6	VA91302-2	VA91302-7
	Outside Rose for All Functions, Inside Rose For All functions except GT135LED, GT145	\$43	—	V32006-5	V32006-8	V32006-3	V32006-6	V32006-2	V32006-7
	Inside Rose w/Locking Directional Arrow For Functions GT135LED, GT145		—	VA10093-5	VA10093-8	VA10093-3	VA10093-6	VA10093-2	VA10093-7
	"T" STRIKE SQUARE CORNERS 1-1/8" X 2-3/4" X 3/32"	\$17	—	V919050-5	V919050-8	V919050-3	V919050-6	V919050-2	V919050-7
	ASA ANSI STRIKE 1-1/4" X 4-7/8" X 3/32"	\$38	—	V91905-5	V91905-8	V91905-3	V91905-6	V91905-2	V91905-7
	"FULL LIP" STRIKE 1-5/8" X 2-1/4" X 3/32"	\$14	—	V919051-5	V919051-8	V919051-3	V919051-6	V919051-2	V919051-7
	SCREW PACK - INCLUDES MOUNTING SCREWS, HEX KEY(M5 X .8) AND PICK.	\$12	—	VA10030-5	VA10030-8	VA10030-3	VA10030-6	VA10030-2	VA10030-7
	SPACER — For 1-3/8" doors. Sold as a pair. To be installed as a set.	\$64	V32433						
	EXTENSION — Converts standard latchbolt from 2-3/4" Backset to 5"	\$58	VA21902						
	EXTENSION — Converts standard latchbolt from 2-3/8" Backset to 3-3/4"		VA21903						
	CENTERING PLATE — 1-1/8" latch Front Filler Plate. Centers and supports latch bolt when used in hollow stile doors must be ordered with lock from factory.	\$75	V21904						
	DISPOSABLE CORE FOR SFIC	\$9	VA10100						
	TAILPIECE WITH SPRING FOR SFIC HOUSING	\$12	VP92905						
	TAILPIECE FOR XGT/GT/GP KEY IN KNOB CYLINDER	\$5	V32106						
	DUST BOX FOR "T" STRIKE	\$8	I0251						
	DUST BOX FOR ASA (ANSI)		Y025-SBX						
	DUST BOX FOR FULL LIP STRIKE		I0251R						
	Boring Jig — Locates off 2-1/8" bore to drill 5/16"DIA anti-rotation through-bolts	\$100	V11225						
	LEVER RETURN SPRING	\$5	V32015-1 V32015-2 V32015-3						

*Available in 626 only. 1-1/8" faceplate-lock must be 2-3/4" Backset.



XGT SERIES
CYLINDRICAL LOCKS

XGT SERIES PARTS

LIST PRICE

Effective July 3, 2023

XGT SERIES
CYLINDRICAL LOCKS

REPLACEMENT LEVERS	DESCRIPTION	LIST PRICE	FINISHES						LIST PRICE	FINISH 626	
			605	606	612	613E	622	625			
 BOSTON	Non-Cylinder Plain	\$150	V32319-5	V32319-8	V32319-3	V32319-6	V32319-H	V32319-2	\$140	V32319-7	
	Non-Cylinder with button lock		V32321-5	V32321-8	V32321-3	V32321-6	V32321-H	V32321-2		V32321-7	
	Conventional Key in Knob/Lever		V32320-5	V32320-8	V32320-3	V32320-6	V32320-H	V32320-2		V32320-7	
	Small Format Interchangeable Core		V32327-5	V32327-8	V32327-3	V32327-6	V32327-H	V32327-2		V32327-7	
 MIAMI	Non-Cylinder Plain		V32361-5	V32361-8	V32361-3	V32361-6	V32361-H	V32361-2		V32361-7	
	Non-Cylinder with button lock		V32360-5	V32360-8	V32360-3	V32360-6	V32360-H	V32360-2		V32360-7	
	Conventional Key in Knob/Lever		V32362-5	V32362-8	V32362-3	V32362-6	V32362-H	V32362-2		V32362-7	
	Small Format Interchangeable Core		V32364-5	V32364-8	V32364-3	V32364-6	V32364-H	V32364-2		V32364-7	
 PHILADELPHIA	Non-Cylinder Plain		-	V32305-5	V32305-8	V32305-3	V32305-6	V32305-H		V32305-2	V32305-7
	Non-Cylinder with button lock			V32307-5	V32307-8	V32307-3	V32307-6	V32307-H		V32307-2	V32307-7
	Conventional Key in Knob/Lever			V32306-5	V32306-8	V32306-3	V32306-6	V32306-H		V32306-2	V32306-7
	Small Format Interchangeable Core			V32322-5	V32322-8	V32322-3	V32322-6	V32322-H		V32322-2	V32322-7
	Large Format Interchangeable Core								V32427-7		



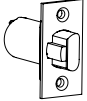
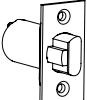
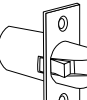

ALL LEVERS

LATCHBOLTS	DESCRIPTION	LIST PRICE	FINISHES						
			605	606	612	613E	622	625	626
	Standard Latchbolt With Dead Latch 2-3/8" Backset, 1/2" Throw for locking functions. Faceplate: 2-1/4" X 1-1/8", Square Corners. See note 1.	\$115	V91904-521	V91904-821	V91904-321	V91904-621	V91904-H21	V91904-221	V91904-721
	Standard Latchbolt With Dead Latch 2-3/4" Backset, 9/16" Throw for all functions. Faceplate: 2-1/4" X 1-1/8", Square Corners	\$130	V91904-511	V91904-811	V91904-311	V91904-611	V91904-H11	V91904-211	V91904-711
	Latchbolt With Dead Latch For Double Doors 2-3/4" Backset, 3/4" Throw Faceplate: 2-1/4" X 1-1/8", Square Corners	\$260	V91904-511DD	V91904-811DD	V91904-311DD	V91904-611DD	V91904-H11DD	V91904-211DD	V91904-711DD

Note: Replacement latch for 3-3/4" Backset applications when used with V21902 extension or factory assembled locks with 2-3/8" Backset. NOT INTENDED FOR FIELD RETROFIT.

PDQ Functions

FUNCTION	FUNCTION NUMBER	INSIDE OUTSIDE	DESCRIPTION	ANSI NUMBER
NON KEYED				
Passage / Closet	XGT126™		<ul style="list-style-type: none"> Latchbolt operated by lever from either side at all times 	F75
Time Out Lock	XGT173		<ul style="list-style-type: none"> Latchbolt by lever from either side unless push button on outside is depressed. Lock returns to passage mode upon release of push button. Inside lever locked only when pushing button on outside lever. Inside lever unlocked by emergency release of button from outside. 	—
Hospital Privacy	XGT175		<ul style="list-style-type: none"> Latchbolt operated by lever from either side or emergency turn piece in outside lever Outside lever locked by push button on inside Outside lever unlocked by emergency turn piece from outside, rotating inside lever, or closing door 	—
Privacy Bedroom / Bathroom	XGT176™		<ul style="list-style-type: none"> Latchbolt operated by lever from either side or emergency release in outside lever Outside lever locked by push button on inside Outside lever unlocked by emergency release from outside, rotating inside lever, or closing door 	F76
Patio	XGT177		<ul style="list-style-type: none"> Latchbolt operated by lever from either side Outside lever locked by push button on inside Outside lever unlocked by rotating inside lever, or closing door Outside lever has non-removable security features 	F77
KEYED				
Storeroom	XGT115		<ul style="list-style-type: none"> Latchbolt operated by inside lever or key in outside lever Outside lever always fixed 	F86
Entrance	XGT116		<ul style="list-style-type: none"> Latchbolt operated by lever from either side or key in outside lever Outside lever locked by push/turn button on inside When outside lever is locked by push button on inside – key from outside, or rotating inside lever unlocks outside lever When outside lever is locked by pushing and turning button on the inside, key from outside or rotating inside lever retracts latch but does not unlock outside lever 	F109
Security	XGT120		<ul style="list-style-type: none"> Latchbolt operated by lever from either side Key on outside locks inside lever Key on outside unlocks inside lever Outside keyed lever always free Inside lever has non-removable security features 	—
Utility Asylum / Institution	XGT128		<ul style="list-style-type: none"> Both levers rigid Latchbolt retracted by key on both sides Can only gain entry or exit by key 	F87
Exit or Twin Communicating	XGT129		<ul style="list-style-type: none"> Latchbolt operated by key in inside lever Inside lever always fixed Blank plate outside Minimum clearance of 1-1/2" between doors Frame depth 7-1/8" 	—
Vestibule Class Room Security	XGT135		<ul style="list-style-type: none"> Latchbolt operated by lever from either side Key in either lever locks outside lever Key in either lever unlocks outside lever Inside lever always free 	F110





INDICATES RIGID LEVER

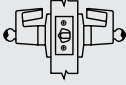
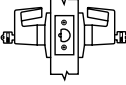
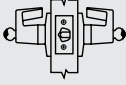
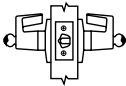
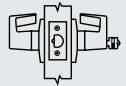

PDQ Functions

XGT SERIES
CYLINDRICAL LOCKS

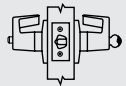
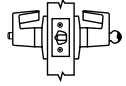
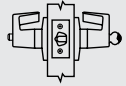
FUNCTION	FUNCTION NUMBER	INDISE OUTSIDE	DESCRIPTION	ANSI NUMBER
KEYED				
Vestibule Class Room Security	XGT135LED		<ul style="list-style-type: none"> Latchbolt operated by lever from either side Key in either lever locks outside lever Key in either lever unlocks outside lever Inside lever always free Red LED Outside Lever Status Indicator Lock Directional Arrow Patent #9,187,928 	F110
Store Door	XGT137		<ul style="list-style-type: none"> Latchbolt operated by lever from either side Both levers locked by key from either side Both levers unlocked by key from either side 	F91
Communicating	XGT141		<ul style="list-style-type: none"> Latchbolt operated by lever from either side Key in either side locks or unlocks its own lever independently 	F80
Vestibule Class Room Security	XGT145		<ul style="list-style-type: none"> Latchbolt operated by lever from either side Key in either lever locks outside lever Key in either lever unlocks outside lever Inside lever always free Lock Directional Arrow* 	F110
Classroom	XGT148		<ul style="list-style-type: none"> Latchbolt operated by lever from either side Outside lever locked by key from outside Outside lever unlocked by key from outside Inside lever always operates latch 	F84
Exit or Twin Communicating	XGT150		<ul style="list-style-type: none"> Latchbolt operated by inside lever Blank plate outside Inside lever locked by key inside Inside lever unlocked by key inside Minimum clearance of 1-1/2" between doors Use only in rooms with more than one exit Frame depth 7-1/8" 	—
Service Station	XGT155		<ul style="list-style-type: none"> Latchbolt operated by lever from either side or key in outside lever Outside lever locked by push button on inside When outside lever is locked by push button on inside – key from outside, rotating inside lever, or closing door unlocks outside lever When outside lever is locked by pushing and turning the slotted button on the inside, key from outside or rotating inside lever retracts latch but does not unlock outside lever 	F92
Dormitory / Corridor	XGT165		<ul style="list-style-type: none"> Latchbolt operated by lever from either side or key in outside lever Outside lever locked by key on outside or push button on inside Outside lever unlocked by key in outside lever, closing door, or rotating inside lever Inside lever always free 	F90
Entry	XGT182		<ul style="list-style-type: none"> Latchbolt operated by lever from either side or key in outside lever Outside lever locked by push button on inside Outside lever unlocked by key from outside, or rotating inside lever 	F82

Cross Reference

ANSI # / FUNCTION	PDQ	SARGENT	CORBIN	SCHLAGE
F75 — PASSAGE	XGT 126	11U15	CL3310	ND10S
F76 — PRIVACY	XGT 176	11U65	CL3320	ND40S
F82 — ENTRY	XGT 182	11G24	CL3361	ND50PD
F84 — CLASSROOM	XGT 148	11G37	CL3355	ND70PD
F86 — STORE ROOM	XGT 115	11G04	CL3357	ND80PD
F90 — CORRIDOR	XGT 165	11G54	CL3375	ND73PD
F110 — INTRUDER CLASSROOM	XGT 135	11G38	CL3352	ND95PD
F110 — INTRUDER CLASSROOM W/LED INDICATOR	XGT 135 LED PDQ Exclusive - Patent #9,187,928	N/A	N/A	N/A

Lever Cross Reference

PDQ	SARGENT	CORBIN	SCHLAGE
PHILADELPHIA — PHL	L Lever	NZD	RHO
BOSTON — BSN	P Lever	PZD	SPA
MIAMI — MIA	B Lever	AZD	ATH



PHILADELPHIA — PHL



BOSTON — BSN



MIAMI — MIA

Information on this sheet is compiled from public documents and third parties. As a result, PDQ makes no guarantees as to their accuracy, content, quality or availability. Comparisons were made using the technical features only and are not commercial comparisons. Final suitability should be determined by a professional hardware consultant.

 **ALL LEVERS**



ASSEMBLED
IN THE USA

Typical Applications

- Federal and State Government
- Healthcare
- Higher Education
- Hospitality
- Houses of Worship
- Industrial
- K-12 Education
- Offices
- Public Buildings

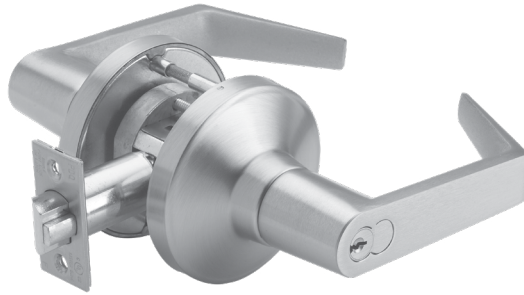

Specifications



FOR DOORS:	• 1-3/4" to 2-1/4" thick • Preset for 1-3/4" door
APPLICATION:	• Through door thru-bolting
DOOR PREP:	• Standard ANSI A156.115 (I61) for Cylindrical Locks
BACKSET:	• 2-3/4" Standard, 2-3/8", 3-3/4" and 5" Optional (Ordered from factory only).
CHASSIS:	• Heavy duty diecast, investment cast, chromated cold rolled steel and stainless steel mechanism. Billet Steel spindles for locking functions
FRONT:	• 2-1/4" x 1-1/8" • Stainless Steel or Wrought Brass • Beveled 1/8" in 2"
STRIKE	• ASA standard • T-Strike or Full Lip Strike optional • Stainless Steel or Wrought Brass
LEVERS:	• Philadelphia (SFL and LFL), Boston (SFL), Miami (SFL)
ROSE:	• 3-3/8" DIA Wrought
LATCHBOLT:	• 9/16" Throw Deadlocking • 3/4" Latch projection for available as option.
HAND:	• Non-handed
TRIM:	• Solid diecast PHL, BSN or MIA Levers • 41° Lever Rotation Standard with 2-3/4" Backset • Wrought Brass Roses, Concealed Screws • 65° Lever Rotation Standard with 3/4" latch for double doors (Ordered from factory only) and all 2-3/8", 3-3/4" and 5" Backsets (Ordered from factory only)
KEYS:	• Two (2) per Lock
KEYWAYS	• SCC standard (Schlage C Compatible) • Also available in keyways of other manufacturers
INTERCHANGEABLE CORE:	• Available for all keyed functions • 6 or 7-pin • Large Format IC Core available for PHL Lever ONLY. • Compatible with Best, Falcon and Arrow small format IC cores
CYLINDER:	• 6-pin Brass Insert Cylinder keyed to 5-pins • Standard High Security and UL437 Cylinders Available
KEYING:	• Options: MK, CMK or GMK • Zero Bitted (KO), Keyed Different (KD) or Keyed Alike (KA) Can be keyed into existing master key systems
FINISHES:	• 605 (US3), 606 (US4), 612 (US10), 613E, 619 (US15), 622 (US19), 625 (US26), 626 (US26D) • Optional Antimicrobial Coating 626 (USD26D) only†
CERTIFICATIONS, LISTINGS, COMPLIANCES:	• UL listed for 3 hrs, for single doors up to 4'0" x 8'0" • Optional 3/4" (19mm) throw deadlocking fire latch (FRL) available for pairs of doors • Certified to ANSI/BHMA A156.2, Grade 1 • California Education Code Compliant (Functions GT135, GT135LED, GT145) • Federal Specification FF-H-10C (Superseded by A156.2) • Approved for Florida HVHZ (High Velocity Hurricane Zone). PDQ Product Approval: FL 21376. Design load rating: ± 70.0 PSF for single door (3' x 7') • Complies with ADA (Americans with Disabilities Act) and ICC/ANSI 117.1 for Accessible and Usable Buildings
WARRANTY:	• Twenty-five (25) year Limited Warranty
COUNTRY OF ORIGIN:	• Proudly Assembled in the U.S.A. with U.S. and foreign material. Meets requirements of the Buy American Act as a COTS product manufactured in the United States.

† Available with antimicrobial powder coating, treated with silver ionic technology that is known to inhibit the growth of microbes.

GT SERIES

LIST PRICE

Effective July 3, 2023

How to Order



QUANTITY	SERIES	FUNCTION	LEVER	FINISH	BACKSET	STRIKE	CYLINDER	KEYWAY	KEYING	OPTION
6	GT	150	PHL	626	234	ASA	D	SCC	KD	—
			BSN	605	234 — 2-3/4"	ASA — ANSI/ASA (default)	D Default	PAGE 49		TC1S — Tactile Abrasive Coating - Inside only
			MIA	606	238 — 2-3/8"	ASA — ANSI/ASA (default)	L Less Cylinder			TCIOS — Tactile Abrasive Coating - Outside only
			PHL	612	334F — 3-3/4x1"	FL — Full Lip	SF6 Lock is SFIC prepped w/ 6 pin core			TC2 — Tactile Abrasive Coating - Both Sides
				613E	334 — 3-3/4"	T — "T" Strike	SF7 Lock is SFIC prepped w/ 7 pin core			SF — Split Finishes
				619	622		SFL Lock is SFIC prepped but less core			LL — Lead-Lined Rose
				625	625		SFC Lock is SFIC prepped w/ construction core			DB — Dust Box
				626	626		SFP Lock is SFIC prepped w/ plastic construction core			AM — Antimicrobial Coating
							LF6 Lock is Schlage LFIC prepped w/ Schlage core			REX — Request to Exit
							LFL Lock is Schlage LFIC prepped but less core			
							LFC Lock is Schlage LFIC prepped w/ construction core			
										PAGE 50

NOTE: Case quantity is 6/ case weight is 33lbs. Keyed Functions/Case Weight is 31lbs. Non-Keyed Functions/ For split finishes, designate O/S trim first, then I/S

GT SERIES
CYLINDRICAL LOCKS

Locksets - Standard and Interchangeable Cores

ANSI NO.	FUNCTION	DESCRIPTION	626	605/606/612 613E/619/622/625
NON-CYLINDER				
F89	124	Exit		
	125	Communicating	\$338.00	\$360.00
F75	126	Passage		
	173	Time Out		
	175	Hospital / Privacy	\$385.00	\$407.00
F76	176	Privacy		
F77	177	Patio / Privacy		
	205	Double Dummy	\$222.00	\$244.00
	211	Single Dummy	\$140.00	\$151.00
SINGLE CYLINDER				
F86	115	Store Room		
F109	116	Entrance		
F84	148	Classroom	\$449.00	\$471.00
	150	Exit / Twin Communicating		
F82	182	Office / Entry		
	120	Security	\$469.00	\$491.00
	129	Exit / Twin Communicating		
F92	155	Service Station	\$509.00	\$531.00
F90	165	Dormitory / Corridor		
DOUBLE CYLINDER				
F87	128	Institution	\$519.00	\$541.00
F110	135	Classroom / Security		
F110	135LED	Classroom/Security w/Red LED Outside Lever Status Indicator	\$688.00	\$710.00
F110	145	Classroom / Security w/Locking Direction Arrow		
F91	137	Store Door	\$543.00	\$565.00
F80	141	Communicating		
ELECTRIFIED				
	199A	Store Room	\$929.00	\$951.00

CYLINDER OPTIONS	ICON	LOCK ADJUSTMENT
D		
SFL		N/C
LFL*		

IC Core not included see page 49 for core options.

LFC prep only available in PHL lever and 613E, 622, 626 finish.

NOTES:
• Locks will be furnished with ASA Strike & SCC Keyway unless otherwise stated

Trim/Levers

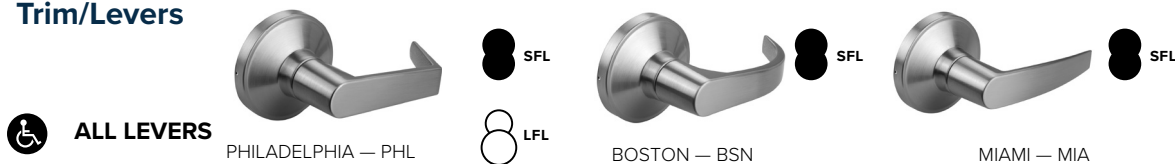

 ALL LEVERS

PHILADELPHIA — PHL

BOSTON — BSN

MIAMI — MIA



Backset

CODE	DESCRIPTION	LOCK ADJUSTMENT
2-3/4" BACKSET		
234	2-3/4" Deadlocking 2-1/4" x 1-1/8"	N/C
238	2-3/8" Deadlocking 2-1/4" x 1"	
3-3/4" BACKSET		
334F	2-1/4" x 1-1/8"	\$18
334	2-1/4" x 1"	
5" BACKSET		
5	2-1/4" x 1-1/8"	\$24

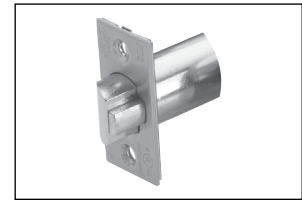

Latchbolt

GT SERIES
CYLINDRICAL LOCKS

Strikes

	CODE	DESCRIPTION	LOCK ADJUSTMENT
	ASA	ASA Strike (any finish) 1-1/4" x 4-7/8"	N/C
	T	T-Strike (any finish) 1-1/8" x 2-3/4"	
	FL	Full Lip Strike (any finish) 1-5/8" x 2-1/4"	

NOTES:

- Specify finish for Strikes & Latchbolts if ordered separately

NOTES:

- Specify finish for cylinders ordered separately
- Kwikset cylinder available in 5 pin only
- Specify KD, KA4, or 1 bitted 6 pin cylinder keyed for 5 pin

Keyways and Cylinders

PDQ KEYWAY	COMPATIBLE WITH	SOLD WITH LOCK
AR1	Arrow / AR1	N/C
CO59A1	Corbin / 59A1	
CO6	Corbin / 60	
CL4	Corbin / L4	
RUD	Russwin / D1	
SCE	Schlage / E	
SCC	Schlage / C	
SCC-K	Schlage / C-K	
SAL	Sargent / LA	
RA-RC	Sargent / RA-RC	
YA8	Yale / E1R	
GA	Yale / GA	
FAL	Falcon / E-R	
KW	Kwikset	
TA	PDQ / TA (Restricted. Limited to Grandmaster systems w/4 masters)	
Dummy	—	
T-Turn	—	
L	Less Cylinder	Deduct \$4.00
HIGH SECURITY CYLINDERS AND CORES		
SEE HIGH SECURITY CYLINDERS AND CORES SECTION, PAGE 118.		

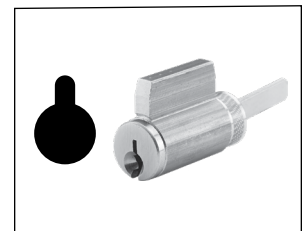

Key in Knob/Lever Cylinder



UL 437 and High Security Cylinders

Cores and Keyways

DESCRIPTION	PDQ NO.	ADD
SMALL FORMAT UNCOMBINATED		
6 Pin Cores	I5206 + KEYWAY	\$40.00
7 Pin Cores	I5207 + KEYWAY	
COMBINATED		
6 Pin Cores	I5206-1 + KEYWAY	\$60.00
7 Pin Cores	I5207-1 + KEYWAY	
BEST™ Compatible		
A (DEFAULT), B, C, D, E, F, G, H, J, K, L, M, Q,		
WA, WB, WC, WG, WH, TB, TD, TE, & R		
PDQ Exclusive		
PDQ1, PDQ2		
PDQ Exclusive and Restricted		
PDQ3		
SFIC CONSTRUCTION		
Construction Core 6-pin only		\$60.00
Dummy Construction Core Plastic		\$8.00
LFIC CONSTRUCTION		
Construction Core 6-pin only. Construction cores are invoiced at shipment and credited upon return.		\$70.00
IC Tailpiece Assembly		\$10.00
LFIC COMBINATED		
Schlage compatible LFIC, SCC (Schlage C compatible) keyway		\$70.00
PDQ TA LFIC Restricted		
LFIC UNCOMBINATED		
Schlage compatible LFIC, SCC (Schlage C compatible) keyway		\$50.00
HIGH SECURITY IC CORES		
SEE HIGH SECURITY CYLINDERS AND CORES SECTION, PAGE 118. — LFIC REQUIRES LARGE FORMAT LEVER		

- NOTES:**
- Specify finish for IC Cores ordered separately
 - Control keys must be ordered separately
 - PDQ1, PDQ2, PDQ3 (Restricted)**, Best A2 & A4 Systems Available

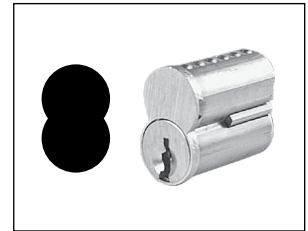

SFL/SFIC Core

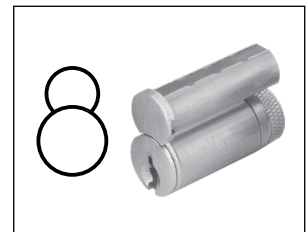

LFL/LFIC Schlage Format



UL 437 and High Security Cylinders

Options

CODE	DESCRIPTION	LIST PRICE
TC1IS	Tactile Abrasive Coating - Inside only	\$26.00
TC1OS	Tactile Abrasive Coating - Outside only	
TC2	Tactile Abrasive Coating - Both Sides	\$52.00
LL	Lead-Lined Rose	\$214.00
DB	Dust Box	\$8.00
FRL	Fire Rated Latch - 3/4" Throw for double doors	\$99.00
AM	Antimicrobial Coating, Lever Set Includes Inside and Outside Lever and Rose (Not available with 605 or 625 finish)	\$37.00
REX	Request to Exit	\$122.00

GT SERIES
CYLINDRICAL LOCKS















Accessories

Electrified Hinges Now Available - See Hinge Section

DESCRIPTION	PDQ NO.	LIST PRICE
Electric Strike for Locks (U.L. Listed)	85001	\$650.00

GT SERIES PARTS

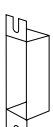
LIST PRICE
Effective July 3, 2023

	DESCRIPTION	LIST PRICE	FINISHES							
			N/A	605	606	612	613E	622	625	626
	Push Button For Functions GT155, GT165, GT173, GT175, GT176, GT177, GT182	\$13	—	VA91302-5	VA91302-8	VA91302-3	VA91302-6	VA91302-H	VA91302-2	VA91302-7
	Outside Rose for All Functions, Inside Rose For All functions except GT135LED, GT145	\$43	—	V32006-5	V32006-8	V32006-3	V32006-6	V32006-H	V32006-2	V32006-7
	Inside Rose w/Locking Directional Arrow For Functions GT135LED, GT145		—	VA10093-5	VA10093-8	VA10093-3	VA10093-6	VA10093-H	VA10093-2	VA10093-7
	"T" STRIKE SQUARE CORNERS 1-1/8" X 2-3/4" X 3/32"	\$17	—	V919050-5	V919050-8	V919050-3	V919050-6	V919050-H	V919050-2	V919050-7
	ASA ANSI STRIKE 1-1/4" X 4-7/8" X 3/32"	\$38	—	V91905-5	V91905-8	V91905-3	V91905-6	V91905-H	V91905-2	V91905-7
	"FULL LIP" STRIKE 1-5/8" X 2-1/4" X 3/32"	\$14	—	V919051-5	V919051-8	V919051-3	V919051-6	V919051-H	V919051-2	V919051-7
	SCREW PACK - INCLUDES MOUNTING SCREWS, HEX KEY(M5 X .8) AND PICK.	\$12	—	VA10030-5	VA10030-8	VA10030-3	VA10030-6	VA10030-H	VA10030-2	VA10030-7
	SPACER — For 1-3/8" doors. Sold as a pair. To be installed as a set.	\$64	V32433							
	EXTENSION — Converts standard latchbolt from 2-3/4" Backset to 5"	\$58	VA21902							
	EXTENSION — Converts standard latchbolt from 2-3/8" Backset to 3-3/4"		VA21903							
	CENTERING PLATE — 1-1/8" latch Front Filler Plate. Centers and supports latch bolt when used in hollow stile doors must be ordered with lock from factory.	\$75	V21904							
	DISPOSABLE CORE FOR SFIC	\$9	VA10100							
	TAILPIECE WITH SPRING FOR SFIC HOUSING	\$12	VP92905							
	TAILPIECE FOR XGT/GT/GP KEY IN KNOB CYLINDER	\$5	V32106							
	DUST BOX FOR "T" STRIKE	\$8	I0251							
	DUST BOX FOR ASA (ANSI)		Y025-SBX							
	DUST BOX FOR FULL LIP STRIKE		I0251R							
	Boring Jig — Locates off 2-1/8" bore to drill 5/16"DIA anti-rotation through-bolts	\$100	V11225							
	LEVER RETURN SPRING	\$5	V32015-1 V32015-2 V32015-3							

GT SERIES
CYLINDRICAL LOCKS



*Available in 626 only. 1-1/8" faceplate-lock must be 2-3/4" Backset.

GT SERIES PARTS

LIST PRICE

Effective July 3, 2023

GT SERIES
CYLINDRICAL LOCKS

REPLACEMENT LEVERS	DESCRIPTION	LIST PRICE	FINISHES						LIST PRICE	FINISH 626	
			605	606	612	613E	622	625			
 BOSTON	Non-Cylinder Plain	\$150	V32319-5	V32319-8	V32319-3	V32319-6	V32319-H	V32319-2	\$140	V32319-7	
	Non-Cylinder with button lock		V32321-5	V32321-8	V32321-3	V32321-6	V32321-H	V32321-2		V32321-7	
	Conventional Key in Knob/Lever		V32320-5	V32320-8	V32320-3	V32320-6	V32320-H	V32320-2		V32320-7	
	Small Format Interchangeable Core		V32327-5	V32327-8	V32327-3	V32327-6	V32327-H	V32327-2		V32327-7	
 MIAMI	Non-Cylinder Plain		V32361-5	V32361-8	V32361-3	V32361-6	V32361-H	V32361-2		V32361-7	
	Non-Cylinder with button lock		V32360-5	V32360-8	V32360-3	V32360-6	V32360-H	V32360-2		V32360-7	
	Conventional Key in Knob/Lever		V32362-5	V32362-8	V32362-3	V32362-6	V32362-H	V32362-2		V32362-7	
	Small Format Interchangeable Core		V32364-5	V32364-8	V32364-3	V32364-6	V32364-H	V32364-2		V32364-7	
 PHILADELPHIA	Non-Cylinder Plain		-	V32305-5	V32305-8	V32305-3	V32305-6	V32305-H		V32305-2	V32305-7
	Non-Cylinder with button lock			V32307-5	V32307-8	V32307-3	V32307-6	V32307-H		V32307-2	V32307-7
	Conventional Key in Knob/Lever			V32306-5	V32306-8	V32306-3	V32306-6	V32306-H		V32306-2	V32306-7
	Small Format Interchangeable Core			V32322-5	V32322-8	V32322-3	V32322-6	V32322-H		V32322-2	V32322-7
	Large Format Interchangeable Core										V32427-7





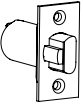
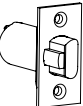
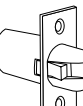

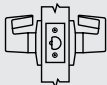

ALL LEVERS

LATCHBOLTS	DESCRIPTION	LIST PRICE	FINISHES						
			605	606	612	613E	622	625	626
	Standard Latchbolt With Dead Latch 2-3/8" Backset, 1/2" Throw for locking functions. Faceplate: 2-1/4" X 1-1/8", Square Corners. See note 1.	\$115	V91904-521	V91904-821	V91904-321	V91904-621	V91904-H21	V91904-221	V91904-721
	Standard Latchbolt With Dead Latch 2-3/4" Backset, 9/16" Throw for all functions. Faceplate: 2-1/4" X 1-1/8", Square Corners	\$130	V91904-511	V91904-811	V91904-311	V91904-611	V91904-H11	V91904-211	V91904-711
	Latchbolt With Dead Latch For Double Doors 2-3/4" Backset, 3/4" Throw Faceplate: 2-1/4" X 1-1/8", Square Corners	\$260	V91904-511DD	V91904-811DD	V91904-311DD	V91904-611DD	V91904-H11DD	V91904-211DD	V91904-711DD

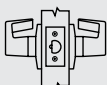
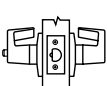
Note: Replacement latch for 3-3/4" Backset applications when used with V21902 extension or factory assembled locks with 2-3/8" Backset. NOT INTENDED FOR FIELD RETROFIT.

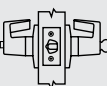
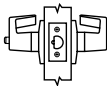
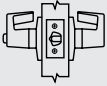
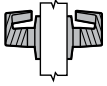
PDQ Functions







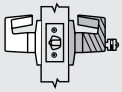
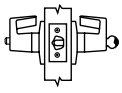
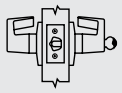

FUNCTION	FUNCTION NUMBER	INSIDE OUTSIDE	DESCRIPTION	ANSI NUMBER
NON KEYED				
Exit	GT124		<ul style="list-style-type: none"> Latchbolt operated by inside lever at all times Outside lever always fixed Outside lever has non-removable security features 	F89
Communicating	GT125		<ul style="list-style-type: none"> Latchbolt operated by inside lever Blank plate outside Minimum clearance of 1-1/2" between doors Frame depth 7-1/8" 	—
Passage / Closet	GT126™		<ul style="list-style-type: none"> Latchbolt operated by lever from either side at all times 	F75
Time Out Lock	GT173		<ul style="list-style-type: none"> Latchbolt by lever from either side unless push button on outside is depressed. Lock returns to passage mode upon release of push button. Inside lever locked only when pushing button on outside lever. Inside lever unlocked by emergency release of button from outside. 	—
Hospital Privacy	GT175		<ul style="list-style-type: none"> Latchbolt operated by lever from either side or emergency turn piece in outside lever Outside lever locked by push button on inside Outside lever unlocked by emergency turn piece from outside, rotating inside lever, or closing door 	—
Privacy Bedroom / Bathroom	GT176™		<ul style="list-style-type: none"> Latchbolt operated by lever from either side or emergency release in outside lever Outside lever locked by push button on inside Outside lever unlocked by emergency release from outside, rotating inside lever, or closing door 	F76
Patio	GT177		<ul style="list-style-type: none"> Latchbolt operated by lever from either side Outside lever locked by push button on inside Outside lever unlocked by rotating inside lever, or closing door Outside lever has non-removable security features 	F77
Double Dummy	GT205		<ul style="list-style-type: none"> Pull lever both sides No mechanical operation 	—
Single Dummy	GT211		<ul style="list-style-type: none"> Pull lever one side No mechanical operation 	—

GT SERIES
CYLINDRICAL LOCKS

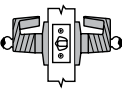
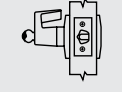
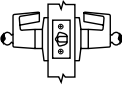
 INDICATES RIGID LEVER

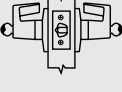
PDQ Functions

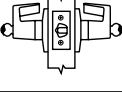
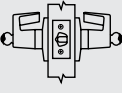
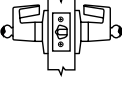



GT SERIES
CYLINDRICAL LOCKS

FUNCTION	FUNCTION NUMBER	INSIDE OUTSIDE	DESCRIPTION	ANSI NUMBER
KEYED				
Storeroom	GT115		<ul style="list-style-type: none"> Latchbolt operated by inside lever or key in outside lever Outside lever always fixed 	F86
Entrance	GT116		<ul style="list-style-type: none"> Latchbolt operated by lever from either side or key in outside lever Outside lever locked by push/turn button on inside When outside lever is locked by push button on inside – key from outside, or rotating inside lever unlocks outside lever When outside lever is locked by pushing and turning button on the inside, key from outside or rotating inside lever retracts latch but does not unlock outside lever 	F109
Security	GT120		<ul style="list-style-type: none"> Latchbolt operated by lever from either side Key on outside locks inside lever Key on outside unlocks inside lever Outside keyed lever always free Inside lever has non-removable security features 	—
Utility Asylum / Institution	GT128		<ul style="list-style-type: none"> Both levers rigid Latchbolt retracted by key on both sides Can only gain entry or exit by key 	F87
Exit or Twin Communicating	GT129		<ul style="list-style-type: none"> Latchbolt operated by key in inside lever Inside lever always fixed Blank plate outside Minimum clearance of 1-1/2" between doors Frame depth 7-1/8" 	—
Vestibule Class Room Security	GT135		<ul style="list-style-type: none"> Latchbolt operated by lever from either side Key in either lever locks outside lever Key in either lever unlocks outside lever Inside lever always free 	F110
Vestibule Class Room Security	 GT135LED		<ul style="list-style-type: none"> Latchbolt operated by lever from either side Key in either lever locks outside lever Key in either lever unlocks outside lever Inside lever always free Red LED Outside Lever Status Indicator Lock Directional Arrow Patent # 9,187,928 	F110
Store Door	GT137		<ul style="list-style-type: none"> Latchbolt operated by lever from either side Both levers locked by key from either side Both levers unlocked by key from either side 	F91
Communicating	GT141		<ul style="list-style-type: none"> Latchbolt operated by lever from either side Key in either side locks or unlocks its own lever independently 	F80
Vestibule Class Room Security	GT145		<ul style="list-style-type: none"> Latchbolt operated by lever from either side Key in either lever locks outside lever Key in either lever unlocks outside lever Inside lever always free Lock Directional Arrow 	F110

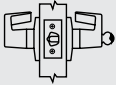

INDICATES RIGID LEVER

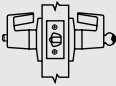
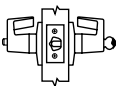
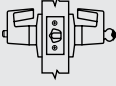
PDQ Functions

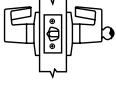
FUNCTION	FUNCTION NUMBER	INSIDE OUTSIDE	DESCRIPTION	ANSI NUMBER
KEYED				
Classroom	GT148		<ul style="list-style-type: none"> Latchbolt operated by lever from either side Outside lever locked by key from outside Outside lever unlocked by key from outside Inside lever always operates latch 	F84
Exit or Twin Communicating	GT150		<ul style="list-style-type: none"> Latchbolt operated by inside lever Blank plate outside Inside lever locked by key inside Inside lever unlocked by key inside Minimum clearance of 1-1/2" between doors Use only in rooms with more than one exit Frame depth 7-1/8" 	—
Service Station	GT155		<ul style="list-style-type: none"> Latchbolt operated by lever from either side or key in outside lever Outside lever locked by push button on inside When outside lever is locked by push button on inside – key from outside, rotating inside lever, or closing door unlocks outside lever When outside lever is locked by pushing and turning the slotted button on the inside, key from outside or rotating inside lever retracts latch but does not unlock outside lever 	F92
Dormitory / Corridor	GT165		<ul style="list-style-type: none"> Latchbolt operated by lever from either side or key in outside lever Outside lever locked by key on outside or push button on inside Outside lever unlocked by key in outside lever, closing door, or rotating inside lever Inside lever always free 	F90
Entry	GT182		<ul style="list-style-type: none"> Latchbolt operated by lever from either side or key in outside lever Outside lever locked by push button on inside Outside lever unlocked by key from outside 	F82
Electrified Storeroom	 GT199A		<ul style="list-style-type: none"> Key outside retracts latchbolt Latchbolt operated by lever from inside Auxiliary latch deadlocks latchbolt Fail safe—latchbolt operated by lever from outside unless electrically locked Fail secure—latchbolt operated by lever from outside when electrically unlocked Accepts 12VDC@.6A, 12VAC@.6A, 24VDC@.3A and 24VAC@.3A Furnished with 6" wire leads 	—



GT SERIES
CYLINDRICAL LOCKS

Cross Reference

ANSI # / FUNCTION	PDQ	BEST	CORBIN	DORMA	FALCON T SERIES	HAGER	MARKS 95 SERIES	SARGENT	SCHLAGE	YALE
F75 PASSAGE	GT 126	93K N	CL3510	C810	101	3410	N	10U15	ND10S	5401LN
F76 PRIVACY	GT 176	93K L	CL3520	C840	301	3440	L	10U65	ND40S	5402LN
F82 ENTRY	GT 182	93K A	CL3561	C850	501	3450	A	10G24	ND50PD	5404LN
F109 ENTRANCE	GT 116	93K AB	CL3551	C853	N/A	3453	N/A	10G05	ND53PD	5404LN
F84 CLASSROOM	GT 148	93K R	CL3555	C870	561	3470	S	10G37	ND70PD	5408LN
F86 STORE ROOM	GT 115	93K D	CL3557	C880	581	3480	F	10G04	ND80PD	5405LN
F90 CORRIDOR	GT 165	93K KT	N/A	C873	571	3473	T	10G54	ND73PD	5422LN
F110 INTRUDER CLASSROOM	GT 135	93K IN	N/A	C877	381	3495	DB	10G38	ND95PD	5418LN
F110 INTRUDER CLASSROOM W/LED INDICATOR	GT 135 LED PDQ Exclusive - Patent #9,187,928	N/A	N/A	N/A	N/A	N/A	N/A	N/A	N/A	N/A
SINGLE DUMMY	GT 211	93K 1DT	CL3550	C801	12	3417	DO	10U93	ND170	5455LN

GT SERIES
CYLINDRICAL LOCKS

Lever Cross Reference

PDQ	BEST	CORBIN	DORMA	FALCON	HAGER	MARKS	SARGENT	SCHLAGE	YALE
PHL — PHILADELPHIA	15	NZD	LR	D	WTS	195	L Lever	RHO	AU
BOSTON — BSN	14	PZD	LC	Q	ARC	295	P Lever	SPA	PB
MIAMI — MIA	16	AZD	LG	A	AUS	495	B Lever	ATH	MO



PHILADELPHIA — PHL



BOSTON — BSN



MIAMI — MIA

Information on this sheet is compiled from public documents and third parties. As a result, PDQ makes no guarantees as to their accuracy, content, quality or availability. Comparisons were made using the technical features only and are not commercial comparisons. Final suitability should be determined by a professional hardware consultant.

 **ALL LEVERS**

Typical Applications

- Apartments
- Back-of-House Hotel/Motel
- Commercial Buildings
- Government Buildings
- High Traffic Areas
- Healthcare
- Houses of Worship
- Military Barracks
- Retail Backroom
- Retrofit/Repair/Replacement

Features

- UL listed for 3-hour fire door
- Exceeds ANSI/BHMA A156.2 Grade 1
- 5 standard functions
- Various strike and latch options to accommodate any opening
- Available in keyways of most major manufacturers
- Tactile abrasive coating option
- Antimicrobial coating option
- Five (5) year limited warranty







Specifications



FOR DOORS:	• 1-3/8" to 2" thick.
DOOR PREP:	• Fits Standard 160 or 161 Door Prep.
BACKSET:	• 2-3/8", 2-3/4", 3-3/4", 5".
CASE:	• Steel, Yellow Chromate Plate
FRONT:	• 2-1/4" x 1-1/8" or 2-1/4" x 1" • Stainless Steel or Wrought Bronze.
STRIKE:	• 4-7/8" x 1-1/4" (ASA). "T" or "FL" Strike Optional. • Stainless Steel or Wrought Bronze.
UL F LATCHBOLT:	• 3 hours of fire testing qualified, stainless steel latch bolt.
ROSE:	• 3" DIA Wrought.
HAND:	• Non-handed.
TRIM:	• CQ ball knob. Stainless steel or wrought brass.
KEYWAYS:	• Available in keyways of most major manufacturers.
CYLINDER:	• Supplied standard to accommodate SFIC core. (Cylinder not included). • Standard High Security and UL437 Cylinders Available
KEYING:	• Standard core is available and can be MK, CMK, GMK, or CK. Available Zero Bitted (KO), Keyed Different (KD), Keyed Alike (KA). Can be keyed into existing masterkey systems of other manufacturers.
FINISHES:	• 630 (US32D)
WARRANTY:	• Five (5) Year Limited Warranty
CERTIFICATIONS, LISTINGS, COMPLIANCES:	• Meets ANSI/BHMA A156.2–2003 Grade 1, surpassed 800,000 cycles • UL/CUL 10C listed for 3 hrs, for single doors up to 4'0" x 8'0" • TAA compliant. Country of origin: Taiwan

‡ Available with antimicrobial coating, technology that is known to inhibit the growth of microbes.

PDQ Functions

FUNCTION	FUNCTION NUMBER	INSIDE OUTSIDE	DESCRIPTION	ANSI NUMBER
NON KEYED				
Passage	126		<ul style="list-style-type: none"> Latchbolt operated by both knobs 	F75
Privacy Bathroom	176		<ul style="list-style-type: none"> Latchbolt operated by both knobs Push button in inside knob locks outside knob Inside knob or closing door releases button Emergency opening from outside 	F76
KEYED				
Storeroom	115		<ul style="list-style-type: none"> Latchbolt operated from outside by key, inside by knob Outside knob is rigid at all times Inside knob always free for immediate exit Deadlocking (guarded) latchbolt 	F86
Entrance	116		<ul style="list-style-type: none"> Latchbolt operated by both knobs Outside knob locked or unlocked by turn/push button Inside knob always free Pushing and turning button locks outside knob requiring use of key until button is manually unlocked Pushing button only locks outside knob until unlocked with key or inside knob is turned 	F109
Classroom	148		<ul style="list-style-type: none"> Latchbolt operated from outside by knob except when locked from outside by key Latchbolt operated from inside by knob at all times Deadlocking (guarded) latchbolt 	F84

How to Order





QUANTITY	SERIES	FUNCTION	KNOB	FINISH	BACKSET	STRIKE	CYLINDER	KEYWAY	KEYING	OPTION
20	SX	116	CQ	630	234	ASA	D	SCC	KD	—
					234 — 2-3/4" 238 — 2-3/8" 334 — 3-3/4" 5 — 5"	ASA — ANSI/ASA (default) FL — Full Lip T — "T" Strike	D Default L Less Cylinder SF6 Lock is SFIC prepped w/ 6 pin core SF7 Lock is SFIC prepped w/ 7 pin core SFL Lock is SFIC prepped but less core SFC Lock is SFIC prepped w/ construction core SFP Lock is SFIC prepped w/ plastic construction core	PAGE 60		DB — Dust Box AM — Antimicrobial Coating
					PAGE 59	PAGE 60		PAGE 61		

NOTE: Case quantity is 10 / Case weight is 32 lbs. Keyed Functions / Case weight is 40 lbs. Non-Keyed Functions / For split finishes, designate O/S trim first, then I/S

Locksets

ANSI NO.	FUNCTION	DESCRIPTION	630
NON-CYLINDER			
F75	126	Passage	\$220.00
F76	176	Privacy	\$265.00
SINGLE CYLINDER			
F86	115	Storeroom	\$285.00
F109	116	Entrance	
F84	148	Classroom/Storage	
List prices shown include conventional key in knob/lever cylinder. For I-C, list prices do not include core.			

CYLINDER OPTIONS	ICON	LOCK ADJUSTMENT
D		N/C
SFL		

Trim



NOTES:

- Locks will be furnished with 2-3/4" Latchbolt, ASA Strike & SCC Keyway unless otherwise stated
- 2-3/4" Latchbolt will be furnished with 2-1/4" x 1-1/8" faceplate unless otherwise stated

Backset

CODE	DESCRIPTION	LOCK ADJUSTMENT
2-3/4" BACKSET		
234	2-1/4" x 1-1/8"	N/C
234F	2-1/4" x 1"	
234FR	2-1/4" x 1" x 1/4" Radius	
2-3/8" BACKSET		
238F	2-1/4" x 1-1/8"	N/C
238	2-1/4" x 1"	
238R	2-1/4" x 1" x 1/4" Radius	
3-3/4" BACKSET		
334F	2-1/4" x 1-1/8"	\$18.00
334	2-1/4" x 1"	
334R	2-1/4" x 1" x 1/4" Radius	
5" BACKSET		
5	2-1/4" x 1-1/8"	\$24.00
5F	2-1/4" x 1"	
5FR	2-1/4" x 1" x 1/4" Radius	



Latchbolt

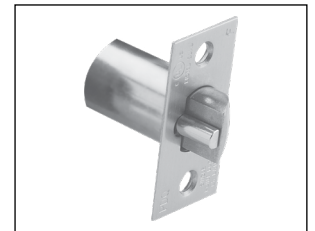

Deadlatch

Strikes

	CODE	DESCRIPTION	LOCK ADJUSTMENT
	ASA	ASA Strike 1-1/4" x 4-7/8" 630 (US32D) Stainless Steel	N/C
	T	T-Strike 1-1/8" x 2-3/4" 630 (US32D) Stainless Steel	
	FL	Full Lip Strike 1-5/8" x 2-1/4" (US32D) Stainless Steel	

NOTES:

- Specify desired finish for Strikes & Latchbolts if ordered separately

Keyways and Cylinders

PDQ KEYWAY	COMPATIBLE WITH	SOLD WITH LOCK	
AR1	Arrow / AR1	N/C	
CO59A1	Corbin / 59A1		
CO6	Corbin / 60		
CL4	Corbin / L4		
RUD	Russwin / D1		
SCE	Schlage / E		
SCC	Schlage / C		
SCC-K	Schlage / C-K		
SAL	Sargent / LA		
RA-RC	Sargent / RA-RC		
YA8	Yale / E1R		
GA	Yale / GA		
FAL	Falcon / E-R		
KW	Kwikset		
TA	PDQ / TA (Restricted. Limited to Grandmaster systems w/4 masters)		
Dummy	—		
T-Turn	—		
L	Less Cylinder		Deduct \$4.00
HIGH SECURITY CYLINDERS AND CORES			
SEE HIGH SECURITY CYLINDERS AND CORES SECTION, PAGE 118.			

- NOTES:
- Specify finish for cylinders ordered separately
 - Kwikset cylinder available in 5 pin only
 - Specify KD, KA4, or 1 bitted
 - 6 pin cylinder keyed for 5 pin

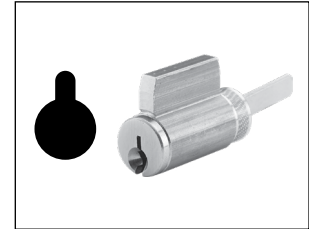

Key in Knob/Lever Cylinder

SX SERIES
CYLINDRICAL LOCKS

Cores and Keyways

DESCRIPTION	PDQ NO.	ADD
SMALL FORMAT UNCOMBINED		
6 Pin Cores	I5206 + KEYWAY	\$40.00
7 Pin Cores	I5207 + KEYWAY	
COMBINED		
6 Pin Cores	I5206-1 + KEYWAY	\$60.00
7 Pin Cores	I5207-1 + KEYWAY	
BEST™ Compatible		
A (DEFAULT), B, C, D, E, F, G, H, J, K, L, M, Q,		
WA, WB, WC, WG, WH, TB, TD, TE, & R		
PDQ Exclusive		
PDQ1, PDQ2		
PDQ Exclusive and Restricted		
PDQ3		
SFIC CONSTRUCTION		
Construction Core 6-pin only		\$60.00
Dummy Construction Core Plastic		\$8.00
HIGH SECURITY IC CORES		
SEE HIGH SECURITY CYLINDERS AND CORES SECTION, PAGE 118. — LFIC REQUIRES LARGE FORMAT LEVER		

- NOTES:
- Specify finish for IC Cores ordered separately
 - Control keys must be ordered separately
 - **PDQ1, PDQ2, PDQ3 (Restricted)**, Best A2 & A4 Systems Available

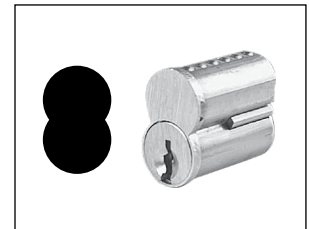

SFL/SFIC Core



UL 437 and High Security Cylinders

Options

CODE	DESCRIPTION	LOCK ADJUSTMENT
DB	Dust Box	\$8.00
AM	Antimicrobial Coating, Knob Set Includes Inside and Outside Knob and Rose	\$37.00

Accessories





Electrified Hinges Now Available - See Hinge Section

DESCRIPTION	PDQ NO.	LIST PRICE
Electric Strike for SX Locks (U.L. Listed)	85001	\$650.00

Backset

CODE	TYPE	FACEPLATE	CORNERS	PDQ NUMBER	LIST PRICE	
2-3/4" BACKSET						
234F	SPRINGLATCH	2-1/4" X 1	SQUARE	V21900-714	\$68.00	
234		2-1/4" X 1-1/8"	SQUARE (DEFAULT)	V21900-712		
234F	DEADLATCH	2-1/4" X 1	SQUARE	V21900-713		
234		2-1/4" X 1-1/8"	SQUARE (DEFAULT)	V21900-711		
2-3/8" BACKSET						
238	SPRINGLATCH	2-1/4" X 1	SQUARE (DEFAULT)	V21900-722		
238F		2-1/4" X 1-1/8"	SQUARE	V21900-724		
238R		2-1/4" X 1	1/4" RADIUS	V21900-722R		
238	DEADLATCH	2-1/4" X 1	SQUARE (DEFAULT)	V21900-721		
238F		2-1/4" X 1-1/8"	SQUARE	V21900-723		
238R		2-1/4" X 1	1/4" RADIUS	V21900-721R		
3-3/4" BACKSET EXTENSION						
Extension for 2-3/8" latch (sold separately) to make 3-3/4" Backset.				V21903	\$55.00	
5" BACKSET EXTENSION						
Extension for 2-3/4" latch (sold separately) to make 5" Backset.				V21902	\$58.00	

Strikes

	CODE	DESCRIPTION	630	LIST PRICE
	ASA	ASA Strike (any finish) 1-1/4" x 4-7/8"	V91900-1	\$38.00
	T	T-Strike (any finish) 1-1/8" x 2-3/4"	V91901-1	\$17.00
	FL	Full Lip Strike (any finish) 1-5/8" x 2-1/4"	V919010-1	\$14.00
		MOUNTING SCREW PACK	X91910	\$12.00
		LATCHBOLT — 2-3/4" DEADLOCKING 2-1/4" X 1-1/8"	I04521-1	\$130.00
		LATCHBOLT — 2-3/8" DEADLOCKING 2-1/4" X 1-1/8"	V91904-721	\$115.00

Durability and Reliability

PDQ's Grade 2 mechanical lock offering includes a range of features, functions, and styles as well as a commitment to deliver durability, convenience, and unmatched value for a wide range of projects and applications.

GP Mechanical

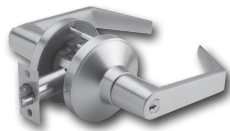

Applications

Heavy-duty performance for high-traffic interior and exterior applications including offices, hospitality, assisted living, church, and other high/medium duty commercial applications. Strong like an ox, over 3x BHMA abusive lever torque test standard.

SD Mechanical

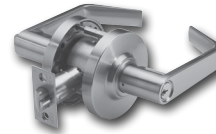

Applications

Built to offer tough and reliable performance at a competitive price. Applications include multi-family, offices, hospitality, assisted living, and other standard duty commercial applications.

CL Interconnected Mechanical



Applications

Offers the security of a deadbolt and lever combined in one product. Applications include hospitality, assisted living, multi-family, offices and retail.

SF Mechanical



Applications

Built to offer tough and reliable performance at a competitive price. Applications include multi-family, offices, hospitality, assisted living, and other standard duty commercial applications.



ASSEMBLED
IN THE USA

Typical Applications

- Government Facilities
- Healthcare
- Higher Education
- Hospitality
- Houses of Worship
- Industrial
- K-12 Education
- Multi-family
- Offices
- Public Buildings

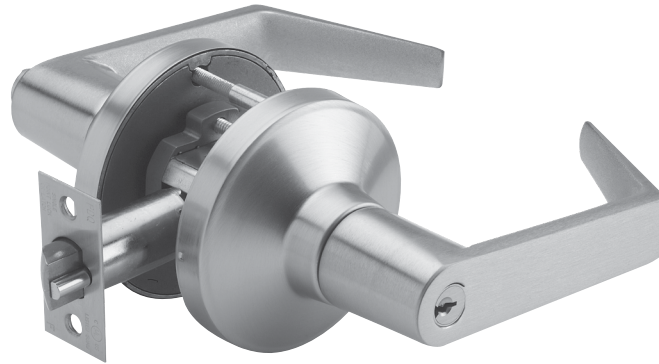

Specifications



FOR DOORS:	• 1-3/8" to 1-3/4" thick • Preset for 1-3/4" door
APPLICATION:	• Through door thru-bolting • Fits 160 and 161 Door prep
BACKSET:	• 2-3/4" standard • 2-3/8", 5" optional
CHASSIS:	• Heavy duty diecast, investment cast, cold rolled steel, stainless steel mechanism
FRONT:	• 2-1/4" x 1-1/8" or 2-1/4" x 1" • Stainless Steel or Wrought Brass • Beveled 1/8" on 2"
STRIKE:	• ASA standard • Stainless Steel or Wrought Brass • T-Strike or Full Lip Strike optional
LEVERS:	Philadelphia (SFL and LFL), Boston (SFL), Miami (SFL)
ROSE:	• 3-3/8" DIA Wrought
LATCHBOLT:	• 1/2" Throw
HAND:	• Non-handed
TRIM:	• Solid diecast PHL, BSN or MIA Levers • 65° Lever Rotation • Wrought Brass Roses • Concealed Screws
KEYS:	• Two (2) per Lock
KEYWAYS:	• SCC standard (Schlage C Compatible) • Compatible with Best, Falcon and Arrow small format IC cores
INTERCHANGEABLE CORE:	• Available for all keyed functions • Large Format IC Core available for PHL Lever ONLY. • 6 or 7-pin • Compatible with Best, Falcon & Arrow
CYLINDER:	• 6-pin Brass Insert Cylinder keyed to 5-pins • Standard High Security and UL437 Cylinders Available
KEYING:	• Options: MK, CMK or GMK • Zero Bitted (KO), Keyed Different (KD) or Keyed Alike (KA) Can be keyed into existing master key systems
FINISHES:	• 605 (US3), 606 (US4), 612 (US10), 613E, 619 (US15), 622 (US19), 625 (US26), 626 (US26D) • Optional Antimicrobial Coating Available with 626 finish only
CERTIFICATIONS, LISTINGS, COMPLIANCES:	• UL listed for 3 hrs, for single doors up to 4'0" x 8'0" • Certified to ANSI/BHMA 156.2, Grade 2 • Complies with ADA (Americans with Disabilities Act) and ICC/ANSI 117.1 for Accessible and Usable Buildings
WARRANTY:	• Eight (8) Year Limited Warranty
COUNTRY OF ORIGIN:	• Assembled in the U.S.A. with U.S. and foreign material. • Meets requirements of the Buy American Act as a COTS product manufactured in the United States.

† Available with antimicrobial coating, technology that is known to inhibit the growth of microbes.

How to Order

QUANTITY	SERIES	FUNCTION	LEVER	FINISH	BACKSET	STRIKE	CYLINDER	KEYWAY	KEYING	OPTION
6	GP	116	PHL	626	234	ASA	D	SCC	KD	—
			BSN	605	234 —	ASA —	D Default	PAGE 67		TC1IS — Tactile Abrasive Coating - Inside only
			MIA	606	2-3/4"	ANSI/ASA	L Less Cylinder			
			PHL	612	238 —	ASA (default)	SF6 Lock is SFIC prepped w/ 6 pin core			TC1OS — Tactile Abrasive Coating - Outside only
				613E	2-3/8"	FL — Full Lip	SF7 Lock is SFIC prepped w/ 7 pin core			
				622	3-3/4"	T — "T" Strike	SFL Lock is SFIC prepped but less core			TC2 — Tactile Abrasive Coating - Both Sides
				625	5 — 5"		SFC Lock is SFIC prepped w/ construction core			
				626			SFP Lock is SFIC prepped w/ plastic construction core			SF — Split Finishes
							LF6 Lock is Schlage LFIC prepped w/ Schlage core			LL — Lead-Lined Rose
							LFL Lock is Schlage LFIC prepped but less core			DB — Dust Box
							LFC Lock is Schlage LFIC prepped w/ construction core			AM — Antimicrobial Coating
								PAGE 66	PAGE 67	PAGE 68

NOTE: Case quantity is 6 / Case weight is 30 lbs. Keyed Functions / Case weight is 29 lbs. Non-Keyed Functions / For split finishes, designate O/S trim first, then I/S

Locksets - Standard and Interchangeable Cores

ANSI NO.	FUNCTION	DESCRIPTION	626	605/606/612 613E/619/622/625
NON-CYLINDER				
	125	Communicating	\$186.00	\$208.00
F75	126	Passage		
F76	176	Privacy	\$217.00	\$239.00
SINGLE CYLINDER				
F86	115	Store Room	\$234.00	\$256.00
F109	116	Entrance		
F84	148	Classroom		
	150	Exit / Twin Communicating		
F82	182	Office / Entry		
DUMMY				
	205	Double Dummy	\$142.00	\$164.00
	211	Single Dummy	\$81.00	\$92.00

List prices shown include cylinder.

CYLINDER OPTIONS	ICON	LOCK ADJUSTMENT
D		
SFL		N/C
LFL*		

IC Core not included see page 67 for core option
LFL prep only available in PHL lever and 613E, 622, 626 finish.

Trim/Levers



ALL LEVERS

NOTES:

- Locks will be furnished with 2-3/4" Latchbolt, ASA Strike & SCC Keyway unless otherwise stated
- 2-3/4" Latchbolt will be furnished with 2-1/4" x 1-1/8" faceplate unless otherwise stated
- 2-3/8" Latchbolt will be furnished with 2-1/4" x 1" faceplate unless otherwise stated
- Split finishes priced at the highest finish price

Backset

CODE	DESCRIPTION	LOCK ADJUSTMENT
2-3/4" BACKSET		N/C
234	2-1/4" x 1-1/8"	
234F	2-1/4" x 1"	
2-3/8" BACKSET		
238F	2-1/4" x 1-1/8"	\$5.00
238	2-1/4" x 1"	
238R	2-1/4" x 1" x 1/4" Radius	\$18.00
3-3/4" BACKSET		
334F	2-1/4" x 1-1/8"	
334	2-1/4" x 1"	
334R	2-1/4" x 1" x 1/4" Radius	\$24.00
5" BACKSET		
5	2-1/4" x 1-1/8"	
5F	2-1/4" x 1"	
5FR	2-1/4" x 1" x 1/4" Radius	



Strikes

	CODE	DESCRIPTION	LOCK ADJUSTMENT
	ASA	ASA Strike (any finish) 1-1/4" x 4-7/8"	N/C
	T	T-Strike (any finish) 1-1/8" x 2-3/4"	
	FL	Full Lip Strike (any finish) 1-5/8" x 2-1/4"	

NOTES:

- Specify finish for Strikes & Latchbolts if ordered separately

Keyways and Cylinders

PDQ KEYWAY	COMPATIBLE WITH	SOLD WITH LOCK	
AR1	Arrow / AR1	N/C	
CO59A1	Corbin / 59A1		
CO6	Corbin / 60		
CL4	Corbin / L4		
RUD	Russwin / D1		
SCE	Schlage / E		
SCC	Schlage / C		
SCC-K	Schlage / C-K		
SAL	Sargent / LA		
RA-RC	Sargent / RA-RC		
YA8	Yale / EIR		
GA	Yale / GA		
FAL	Falcon / E-R		
KW	Kwikset		
TA	PDQ / TA (Restricted. Limited to Grandmaster systems w/4 masters)		
Dummy	—		
T-Turn	—		
L	Less Cylinder		Deduct \$4.00
HIGH SECURITY CYLINDERS AND CORES			
SEE HIGH SECURITY CYLINDERS AND CORES SECTION, PAGE 118			

NOTES:

- Specify finish for cylinders ordered separately
- Kwikset cylinder available in 5 pin only
- Specify KD, KA4, or 1 bitted
- 6 pin cylinder keyed for 5 pin

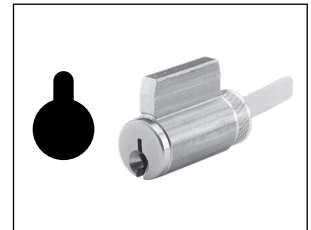

Key in Knob/Lever Cylinder



UL 437 and High Security Cylinders

Cores and Keyways

DESCRIPTION	PDQ NO.	ADD
SMALL FORMAT UNCOMBINATED		
6 Pin Cores	I5206 + KEYWAY	\$40.00
7 Pin Cores	I5207 + KEYWAY	
COMBINATED		
6 Pin Cores	I5206-1 + KEYWAY	\$60.00
7 Pin Cores	I5207-1 + KEYWAY	
BEST[®] Compatible		
A (DEFAULT), B, C, D, E, F, G, H, J, K, L, M, Q, WA, WB, WC, WG, WH, TB, TD, TE, & R		
PDQ Exclusive		
PDQ1, PDQ2		
PDQ Exclusive and Restricted		
PDQ3		
SFIC CONSTRUCTION		
Construction Core 6-pin only		\$60.00
Dummy Construction Core Plastic		\$8.00
LFIC CONSTRUCTION		
Construction Core 6-pin only. Construction cores are invoiced at shipment and credited upon return.		\$70.00
IC Tailpiece Assembly		\$10.00
LFIC COMBINATED		
Schlage compatible LFIC, SCC (Schlage C compatible) keyway		\$70.00
PDQ TA LFIC Restricted		
LFIC UNCOMBINATED		
Schlage compatible LFIC, SCC (Schlage C compatible) keyway		\$50.00
HIGH SECURITY IC CORES		
SEE HIGH SECURITY CYLINDERS AND CORES SECTION, PAGE 118. — LFIC REQUIRES LARGE FORMAT LEVER		

NOTES:

- Combined cores include master keying in the list price
- Specify finish for IC Cores ordered separately
- Control keys must be ordered separately
- **PDQ1, PDQ2, PDQ3 (Restricted)**, Best A2 & A4 Systems Available

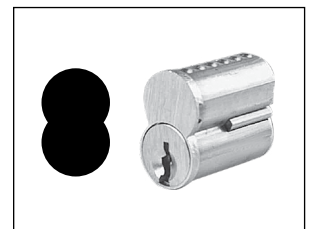

SFL/SFIC Core

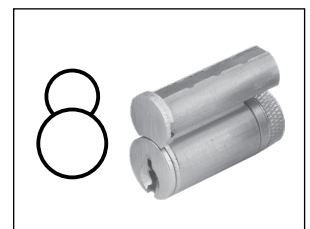

LFL/LFIC Schlage Format

Options

CODE	DESCRIPTION	LOCK ADJUSTMENT
TC1IS	Tactile Abrasive Coating - Inside only	\$26.00
TC1OS	Tactile Abrasive Coating - Outside only	
TC2	Tactile Abrasive Coating - Both Sides	\$52.00
SF	Split Finishes	Higher Finish Price
LL	Lead-Lined Rose	\$214.00
DB	Dust Box	\$8.00
AM	Antimicrobial Coating, Lever Set Includes Inside and Outside Lever and Rose (Available with 626 finish only)	\$40.00

Accessories

Electrified Hinges Now Available - See Hinge Section







DESCRIPTION	PDQ NO.	LIST PRICE
Electric Strike for GP Locks (U.L. Listed)	85001	\$650.00

CODE	TYPE	FACEPLATE	CORNERS	PDQ NUMBER	LIST PRICE	
2-3/4" BACKSET						
234F	SPRINGLATCH	2-1/4" X 1	SQUARE	V21900-714	\$68.00	
234		2-1/4" X 1-1/8"	SQUARE (DEFAULT)	V21900-712		
234F	DEADLATCH	2-1/4" X 1	SQUARE	V21900-713		
234		2-1/4" X 1-1/8"	SQUARE (DEFAULT)	V21900-711		
2-3/8" BACKSET						
238	SPRINGLATCH	2-1/4" X 1	SQUARE (DEFAULT)	V21900-722		
238F		2-1/4" X 1-1/8"	SQUARE	V21900-724		
238R		2-1/4" X 1	1/4" RADIUS	V21900-722R		
238	DEADLATCH	2-1/4" X 1	SQUARE (DEFAULT)	V21900-721		
238F		2-1/4" X 1-1/8"	SQUARE	V21900-723		
238R		2-1/4" X 1	1/4" RADIUS	V21900-721R		
3-3/4" BACKSET EXTENSION						
Extension for 2-3/8" latch (sold separately) to make 3-3/4" Backset.				V21903	\$55.00	
5" BACKSET EXTENSION						
Extension for 2-3/4" latch (sold separately) to make 5" Backset.				V21902		

Strikes

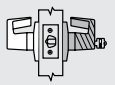
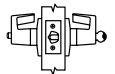
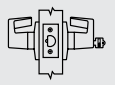
	CODE	DESCRIPTION	605	613E	622	630	LIST PRICE
	ASA	ASA Strike (any finish) 1-1/4" x 4-7/8"	V91900-5	V91900-6	V91900-H	V91900-1	\$38.00
	T	T-Strike (any finish) 1-1/8" x 2-3/4"	V91901-5	V91901-6	V91901-H	V91901-1	\$17.00
	FL	Full Lip Strike (any finish) 1-5/8" x 2-1/4"	V919010-5	V919010-6	V919010-H	V919010-1	\$14.00

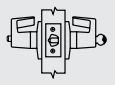
PDQ Functions

FUNCTION	FUNCTION NUMBER	INSIDE OUTSIDE	DESCRIPTION	ANSI NUMBER
NON KEYED				
Communicating	GP125		<ul style="list-style-type: none"> Latchbolt operated by inside lever Blank plate outside Minimum clearance of 1-1/2" between doors Frame depth 7-1/8" Deadlocking (guarded) latchbolt 	—
Passage	GP126		<ul style="list-style-type: none"> Latchbolt operated by lever from either side at all times 	F75
Privacy Bedroom Bathroom	GP176		<ul style="list-style-type: none"> Latchbolt operated by lever from either side or emergency release in outside lever Outside lever locked by push button on inside Outside lever unlocked by emergency release from outside, rotating inside lever, or closing door 	F76
KEYED				
Storeroom	GP115		<ul style="list-style-type: none"> Latchbolt operated by inside lever or key in outside lever Outside lever always fixed 	F86
Entrance	GP116		<ul style="list-style-type: none"> Latchbolt operated by lever from either side or key in outside lever Outside lever locked by push/turn button on inside When outside lever is locked by push button on inside – key from outside, or rotating inside lever unlocks outside lever When outside lever is locked by pushing and turning button on the inside, key from outside or rotating inside lever retracts latch but does not unlock outside lever 	F109
Classroom	GP148		<ul style="list-style-type: none"> Latchbolt operated by lever from either side Outside lever locked by key from outside Outside lever unlocked by key from outside Inside lever always operates latch 	F84
Exit or Twin Communicating	GP150		<ul style="list-style-type: none"> Latchbolt operated by inside lever Blank plate outside Inside lever locked by key inside Inside lever unlocked by key inside Minimum clearance of 1-1/2" between doors Use only in rooms with more than one exit Frame depth 7-1/8" 	—
Entry	GP182		<ul style="list-style-type: none"> Latchbolt operated by lever from either side or key in outside lever Outside lever locked by push button on inside Outside lever unlocked by key from outside, and rotating inside lever 	F82
DUMMY				
Double Dummy	GP205		<ul style="list-style-type: none"> Pull lever both sides No mechanical operation 	—
Single Dummy	GP211		<ul style="list-style-type: none"> Pull lever one side No mechanical operation 	—

GP SERIES
CYLINDRICAL LOCKS



INDICATES RIGID LEVER

Cross Reference

ANSI # / FUNCTION	PDQ	ARROW	BEST	CORBIN	DORMA	FALCON	K2	SARGENT	SCHLAGE	YALE
F75 PASSAGE	GP 126	ML01	73K	CL3810	CL710	B101	QCL230	7U15	AL10	5301LN
F76 PRIVACY	GP 176	ML02	73K	CL3820	CL740	B301	QCL240	7U65	AL40	5303LN
F82 ENTRY	GP 182	NA	73K	CL3861	CL750	B501	NA	NA	AL50	5302LN
F109 ENTRANCE	GP 116	ML11	73K	CL3851	CL753	B511	QCL250	7G05	AL53	5307LN
F84 CLASSROOM	GP 148	ML17	73K	CL3855	CL770	B561	QCL260	7G37	AL70	5308LN
F86 STORE ROOM	GP 115	ML12	73K	CL3857	CL780	B581	QCL270	7G04	AL80	5305LN
SINGLE DUMMY	GP 211	ML08	73K	CL3850	CL701	B12	QCL220	7U93	AL170	5328LN

Lever Comparison

PDQ	ARROW	BEST	CORBIN	DORMA	FALCON	K2	SARGENT	SCHLAGE	YALE
MIAMI — MIA	VR	16	AZD	LG	NA	SLA	B	JUP	MO
PHILADELPHIA — PHL	BRR	15	NZD	LR	D	PNN	L	SAT	AU
BOSTON — BSN	SR	14	PZD	LC	Q	PEA	P	NEP	PB



PHILADELPHIA — PHL



BOSTON — BSN



MIAMI — MIA

Information on this sheet is compiled from public documents and third parties. As a result, PDQ makes no guarantees as to their accuracy, content, quality or availability. Comparisons were made using the technical features only and are not commercial comparisons. Final suitability should be determined by a professional hardware consultant.



Typical Applications

- Assisted Living
- Hospitality
- Houses of Worship
- Industrial
- Medium/Light Commercial Installations
- Multi-family
- Offices
- Retail

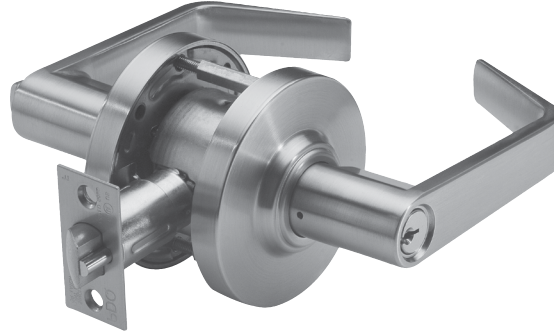

Specifications



FOR DOORS:	• 1-3/8" to 1-3/4" thick • Preset for 1-3/4" door
APPLICATION:	• Through door thru-bolting • Fits standard 160 and 161 Door prep • Thru-Bolts are removable
BACKSET:	• 2-3/4" standard • 2-3/8", 3-3/4", 5" optional
CHASSIS:	• Heavy-gauge cold rolled steel mechanism • Dichromated for corrosion resistance
FRONT:	• 2-1/4" x 1-1/8" or 2-1/4" x 1" • Stainless Steel or Wrought Brass
STRIKE:	• ASA standard • T-Strike or Full Lip Strike optional • Stainless Steel or Wrought Brass
LEVERS:	• Philadelphia, Boston, Miami, Memphis, Orlando
ROSE:	• 3-3/8" DIA Wrought
LATCHBOLT:	• 1/2" Throw
HAND:	• Non-handed (Except Memphis)
TRIM:	• Solid diecast PHL, BSN, MIA, MEM and ORL Levers • Wrought Brass Roses • Concealed Screws
KEYS:	• Two (2) per Lock
KEYWAYS:	• SCC standard (Schlage C Compatible) • Also available in keyways of other manufacturers
INTERCHANGEABLE CORE:	• 6 or 7-pin • Compatible with Best, Falcon & Arrow. Not available with Memphis lever.
CYLINDER:	• 6-pin Brass Insert Cylinder keyed to 5-pins • Standard High Security and UL437 Cylinders Available
KEYING:	• Options: MK, CMK or GMK / Zero Bitted (KO), Keyed Different (KD) or Keyed Alike (KA) • Can be keyed into existing master key systems
FINISHES:	• 605 (US3), 613E, 622 (US19), 626 (US26D) †
CERTIFICATIONS, LISTINGS, COMPLIANCES:	• UL listed for 3 hrs, for single doors up to 4'0" x 8'0" • Certified to ANSI/BHMA A156.2 Grade 2 • Complies with ADA (Americans with Disabilities Act) and ICC/ANSI 117.1 for Accessible and Usable Buildings • TAA compliant. Country of origin: KR
WARRANTY:	• Five (5) year Limited Warranty

† Available with antimicrobial coating, technology that is known to inhibit the growth of microbes.

CODE	DESCRIPTION	LOCK ADJUSTMENT
2-3/4" BACKSET		
234	2-1/4" x 1-1/8"	N/C
234F	2-1/4" x 1"	
234FR	2-1/4" x 1" x 1/4" Radius	
2-3/8" BACKSET		
238F	2-1/4" x 1-1/8"	N/C
238	2-1/4" x 1"	
238R	2-1/4" x 1" x 1/4" Radius	
3-3/4" BACKSET		
334F	2-1/4" x 1-1/8"	\$18
334	2-1/4" x 1"	
334R	2-1/4" x 1" x 1/4" Radius	
5" BACKSET		
5	2-1/4" x 1-1/8"	\$24
5F	2-1/4" x 1"	
5FR	2-1/4" x 1" x 1/4" Radius	

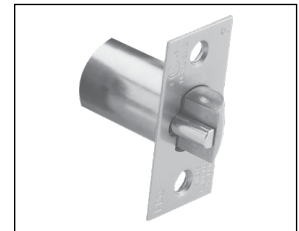

Strikes

	CODE	DESCRIPTION	LOCK ADJUSTMENT
	ASA	ASA Strike (any finish) 1-1/4" x 4-7/8"	N/C
	T	T-Strike (any finish) 1-1/8" x 2-3/4"	
	FL	Full Lip Strike (any finish) 1-5/8" x 2-1/4"	

NOTES:

- Specify finish for Strikes & Latchbolts if ordered separately

Keyways and Cylinders

PDQ KEYWAY	COMPATIBLE WITH	SOLD WITH LOCK
AR1	Arrow / AR1	N/C
CO59A1	Corbin / 59A1	
CO6	Corbin / 60	
CL4	Corbin / L4	
RUD	Russwin / D1	
SCE	Schlage / E	
SCC	Schlage / C	
SCC-K	Schlage / C-K	
SAL	Sargent / LA	
RA-RC	Sargent / RA-RC	
YA8	Yale / E1R	
GA	Yale / GA	
FAL	Falcon / E-R	
KW	Kwikset	
TA	PDQ / TA (Restricted. Limited to Grandmaster systems w/4 masters)	
Dummy	—	
T-Turn	—	
L	Less Cylinder	
HIGH SECURITY CYLINDERS AND CORES		
SEE HIGH SECURITY CYLINDERS AND CORES SECTION, PAGE 118		

- NOTES:**
- Specify finish for cylinders ordered separately
 - Kwikset cylinder available in 5 pin only
 - Specify KD, KA4, or 1 bitted
 - 6 pin cylinder keyed for 5 pin

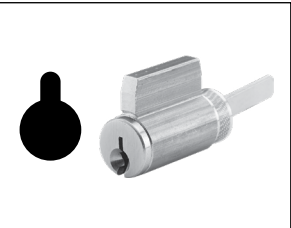

Key in Knob/Lever Cylinder



UL 437 and High Security Cylinders

Cores and Keyways

DESCRIPTION	PDQ NO.	ADD
SMALL FORMAT UNCOMBINED		
6 Pin Cores	I5206 + KEYWAY	\$40.00
7 Pin Cores	I5207 + KEYWAY	
COMBINED		
6 Pin Cores	I5206-1 + KEYWAY	\$60.00
7 Pin Cores	I5207-1 + KEYWAY	
BEST Compatible		
A (DEFAULT), B, C, D, E, F, G, H, J, K, L, M, Q, WA, WB, WC, WG, WH, TB, TD, TE, & R		
PDQ Exclusive		
PDQ1, PDQ2		
PDQ Exclusive and Restricted		
PDQ3		
SFIC CONSTRUCTION		
Construction Core 6-pin only		\$60.00
Dummy Construction Core Plastic		\$8.00
LFIC CONSTRUCTION		
Construction Core 6-pin only		\$70.00
IC Tailpiece Assembly Construction cores are invoiced at shipment and credited upon return.		\$10.00
HIGH SECURITY IC CORES		
SEE HIGH SECURITY CYLINDERS AND CORES SECTION, PAGE		

- NOTES:**
- Specify finish for IC Cores ordered separately
 - Control keys must be ordered separately
 - **PDQ1, PDQ2, PDQ3 (Restricted)**, Best A2 & A4 Systems Available

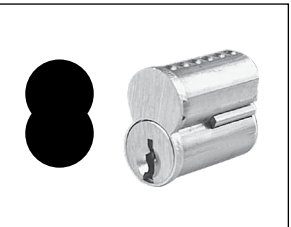

SFL/SFIC Core

Options

CODE	DESCRIPTION	LOCK ADJUSTMENT
SF	Split Finishes	\$8.00
DB	Dust Box	\$8.00

Accessories



Electrified Hinges Now Available - See Hinge Section

DESCRIPTION	PDQ NO.	LIST PRICE
Electric Strike for SD Locks (U.L. Listed)	85001	\$650.00









Backset

CODE	TYPE	FACEPLATE	CORNERS	PDQ NUMBER	LIST PRICE	
2-3/4" BACKSET						
234F	SPRINGLATCH	2-1/4" X 1	SQUARE	V21900-714	\$68.00	
234		2-1/4" X 1-1/8"	SQUARE (DEFAULT)	V21900-712		
234F	DEADLATCH	2-1/4" X 1	SQUARE	V21900-713		
234		2-1/4" X 1-1/8"	SQUARE (DEFAULT)	V21900-711		
2-3/8" BACKSET						
238	SPRINGLATCH	2-1/4" X 1	SQUARE (DEFAULT)	V21900-722		
238F		2-1/4" X 1-1/8"	SQUARE	V21900-724		
238R		2-1/4" X 1	1/4" RADIUS	V21900-722R		
238	DEADLATCH	2-1/4" X 1	SQUARE (DEFAULT)	V21900-721		
238F		2-1/4" X 1-1/8"	SQUARE	V21900-723		
238R		2-1/4" X 1	1/4" RADIUS	V21900-721R		
3-3/4" BACKSET EXTENSION						
Extension for 2-3/8" latch (sold separately) to make 3-3/4" Backset.				V21903	\$55.00	
5" BACKSET EXTENSION						
Extension for 2-3/8" latch (sold separately) to make 5" Backset.				V21902		

Strikes

	CODE	DESCRIPTION	605	613E	622	630	LIST PRICE
	ASA	ASA Strike (any finish) 1-1/4" x 4-7/8"	V91900-5	V91900-6	V91900-H	V91900-1	\$38.00
	T	T-Strike (any finish) 1-1/8" x 2-3/4"	V91901-5	V91901-6	V91901-H	V91901-1	\$17.00
	FL	Full Lip Strike (any finish) 1-5/8" x 2-1/4"	V919010-5	V919010-6	V919010-H	V919010-1	\$14.00

PDQ Functions

FUNCTION	FUNCTION NUMBER	INSIDE OUTSIDE	DESCRIPTION	ANSI NUMBER
NON KEYED				
Communicating	SD125		<ul style="list-style-type: none"> Latchbolt operated by inside lever Blank plate outside Minimum clearance of 1-1/2" between doors Deadlocking (guarded) latchbolt 	—
Passage	SD126		<ul style="list-style-type: none"> Latchbolt operated by lever from either side at all times 	F75
Privacy Bedroom Bathroom	SD176		<ul style="list-style-type: none"> Latchbolt operated by lever from either side or emergency release in outside lever Outside lever locked by push button on inside Outside lever unlocked by emergency release from outside, rotating inside lever, or closing door 	F76
KEYED				
Storeroom	SD115		<ul style="list-style-type: none"> Latchbolt operated from outside by key, inside by lever Outside lever always fixed Inside lever always free Deadlocking (guarded) latchbolt 	F86
Entrance	SD116		<ul style="list-style-type: none"> Latchbolt operated by lever from either side or key in outside lever Outside lever locked by push/turn button on inside or rotating inside lever unlocks outside lever When outside lever is locked by push button on inside – key from outside, or rotating inside lever unlocks outside lever When outside lever is locked by pushing and turning the button on the inside, key from outside or rotating inside lever retracts latch but does not unlock outside lever Deadlocking (guarded) latchbolt 	F109
Classroom	SD148		<ul style="list-style-type: none"> Latchbolt operated by lever from either side Outside lever locked or unlocked by key from outside Inside lever always operates latch Deadlocking (guarded) latchbolt 	F84
Entry	SD182		<ul style="list-style-type: none"> Latchbolt operated by lever from either side or key in outside lever Outside lever locked by push button on inside Outside lever unlocked by key from outside, and rotating inside lever 	F82
DUMMY				
Single Dummy	SD211		<ul style="list-style-type: none"> Pull lever one side No mechanical operation 	—



INDICATES RIGID LEVER

Cross Reference

ANSI # / FUNCTION	PDQ	ARROW	CAL ROYAL	CORBIN	DORMA	FALCON	HAGER	SARGENT	YALE
F75 PASSAGE	SD 126	RL01	SL30	CL3710	C510	W101	2510	6U15	4601LN
F76 PRIVACY	SD 176	RL02	SL20	CL3720	C540	W301	2540	6U65	4602LN
F109 ENTRANCE	SD 116	RL11	SL01	CL3751	C553	W511	2553	65G37	4607LN
F84 CLASSROOM	SD 148	RL17	SL03	CL3755	C570	W561	2570	6G37	4608LN
F86 STORE ROOM	SD 115	RL12	SL05	CL3759	C580	W581	2580	6G04	4605LN
SINGLE DUMMY	SD 211	RL08	SL40	CL3750	C501	W12	2517	6U93	4655LN

Lever Cross Reference

PDQ	ARROW	CAL ROYAL	CORBIN	DORMA	FALCON	HAGER	SARGENT	YALE
MIAMI — MIA		AG	AZD	LG			B	MO
PHILADELPHIA — PHL	BRR	GN	NZD	LR	D	WTS	L	AU
BOSTON — BSN	SR	SPA	PZD	LC	Q	ARC	P	PB
MEMPHIS — MEM								
ORLANDO — ORL								



PHILADELPHIA — PHL



BOSTON — BSN



MIAMI — MIA



MEMPHIS — MEM
(SPECIFY HANDING)



ORLANDO — ORL

Information on this sheet is compiled from public documents and third parties. As a result, PDQ makes no guarantees as to their accuracy, content, quality or availability. Comparisons were made using the technical features only and are not commercial comparisons. Final suitability should be determined by a professional hardware consultant.



Reliable Security for Multi-Family, Multi-Tenant and Light Commercial Applications.

- 5 functions - Privacy, Passage, Entrance Storeroom plus Single Dummy
- Heavier duty cylindrical lock is more durable than a tubular lock
- 5 designer levers to choose from
- 7 architectural finishes
- Stylish 2-9/16" round rose and 2-15/16" square rose
- Retrofits all major manufacturer's door preps
- Adjustable 2-3/8" – 2-3/4" backset latch is standard.
- Optional fixed backset latch adds fire label and BHMA certification.
- Conventional and SFIC core cylinders.
- Anti-lockout kick-off feature (Privacy)
- Suitable for doors 1-3/8" – 1-3/4" thick
- Shares common levers with SD Cylindrical and CL Interconnected locks. Mix and match for a uniform look.



Applications



MULTI-FAMILY HOUSING



SENIOR LIVING



STUDENT HOUSING



LIGHT COMMERCIAL

Specifications



FOR DOORS:	• 1-3/8" to 1-3/4" thick • Preset for 1-3/4" door
APPLICATION:	• Fits standard 160 and 161 door prep • No additional thru-bolt
BACKSET:	• Adjustable - 2-3/8" - 2-3/4" (Optional UL Listed fire latch has fixed backsets, 2-3/8" or 2-3/4")
CHASSIS:	• Heavy-gauge cold rolled steel mechanism • Dichromated for corrosion resistance
FRONT:	• 1" face width, 1/4" radius with square corner filler for 1-1/8" width.
STRIKE:	• Full Lip Strike standard, ASA and T-Strike optional
LEVERS:	• Philadelphia, Boston, Miami, Memphis and Orlando
ROSE:	• 2-9/16" Diameter Round Rose, 2-15/16" Square Rose
LATCHBOLT:	• Adjustable - 2-3/8" - 2-3/4" latch standard for Non-Keyed functions, with optional UL fire-rated 2-3/4" or 2-3/8" fixed backset. • Fixed backset 2-3/8" or 2-3/4" latchbolt standard for Keyed functions.
HAND:	• Non-handed
TRIM:	• Solid diecast PHL, BSN, MIA, MEM and ORL levers • Wrought brass roses • Concealed screws
KEYS:	• Two (2) per Lock
KEYWAYS:	• SCC standard (Schlage C Compatible) • Also available in keyways of other manufacturers
INTERCHANGEABLE CORE:	• 6 or 7-pin • Compatible with Best, Falcon & Arrow. Not available with Memphis lever.
CYLINDER:	• 6-pin Brass Insert Cylinder keyed to 5-pins • Standard High Security and UL437 Cylinders Available
KEYING:	• Options: MK, CMK or GMK / Zero Bitted (KO), Keyed Different (KD) or Keyed Alike (KA) • Can be keyed into existing master key systems
FINISHES:	• 605 (US3), 606 (US4), 613E, 619 (US15), 622 (US19), 625 (US26), 626 (US26D)
CERTIFICATIONS, LISTINGS, COMPLIANCES:	• Entry function and optional fixed backset latch only. – Certified to ANSI/BHMA 156.2, Grade 2 (fixed backset latch only). – UL listed for single doors up to 4'0" x 8'0" when ordered with UL latchbolt, contact factory for details. • Complies with ADA (Americans with Disabilities Act) and ICC/ANSI 117.1 for Accessible and Usable Buildings • TAA compliant. Country of origin: KR
WARRANTY:	• Three (3) year Limited Warranty

SF SERIES

LIST PRICE

How to Order - Non-Keyed Functions

Effective July 3, 2023

SERIES	FUNCTION	LEVER	ROSE	FINISH	LATCH	STRIKE	OPTION
SF	126	PHL	—	626	ADJ	FL	—
	126 — Passage	BSN	BLANK — Round Rose (default) All Levers	605	ADJ* — Non-Fire Rated 1" face width, 1/4" radius corner with 1-1/8" square corner filler.	FL — Full Lip (default)	SF — Split Finishes
	176 — Privacy	MIA		606	234** — Fire Rated Fixed 2-3/4" backset fire rated latch, Square Corner 1-1/8" face	ASA — ANSI/ASA	
	211 — Single Dummy	MEM*		613E	238** — Fire Rated Fixed 2-3/8" backset fire rated latch, Square Corner 1" face	T — "T" Strike	
		ORL	SR — Square Rose (All Levers)	619	238R** — Fire Rated Fixed 2-3/8" backset fire rated latch, Radius Corner 1" face		
		PHL		622			
				625			
				626			
						PAGE 82	PAGE 82

*ADJ latch is standard.

**Optional fixed backset latch adds fire label and BHMA Certification.

How to Order - Keyed Functions

SERIES	FUNCTION	LEVER	ROSE	FINISH	LATCH	STRIKE	CYLINDER	KEYWAY	KEYING	OPTION
SF	116	PHL	—	626	234	FL	D	SCC	KD	—
	115 — Storeroom	BSN	BLANK — Round Rose (default) All Levers	605	234* — Fire Rated Fixed 2-3/4" backset fire rated latch, Square Corner 1-1/8" face	FL — Full Lip (default)	D Default	PAGE 83		SF — Split Finishes
	116 — Entrance	MIA		606	238* — Fire Rated Fixed 2-3/8" backset fire rated latch, Square Corner 1" face	L Less Cylinder	SF6 Lock is SFIC prepped w/ 6 pin core			
		MEM**		613E	238R* — Fire Rated Fixed 2-3/8" backset fire rated latch, Radius Corner 1" face	ASA — ANSI/ASA	SF7 Lock is SFIC prepped w/ 7 pin core			
		ORL	SR — Square Rose (All Levers)	619		T — "T" Strike	SFL Lock is SFIC prepped but less core			
		PHL		622			SFC Lock is SFIC prepped w/ construction core			
			625			SFP Lock is SFIC prepped w/ plastic construction core				
			626						PAGE 82	

*Fire rated, fixed backset latch is standard on keyed functions.

**Memphis not available w/SFIC

Locksets

ANSI NO.	FUNCTION	DESCRIPTION	626/619	605, 606, 613E, 622, 625
NON-CYLINDER				
F75	126	Passage	\$88.00	
F76	176	Privacy	\$92.00	\$100.00
SINGLE CYLINDER				
F86	115	Store Room	\$124.00	\$132.00
F109	116	Entrance		
DUMMY				
	211	Single Dummy	\$44.00	\$48.00

List prices shown include cylinder.

Rose Trim

CODE	DESCRIPTION	LOCK ADJUSTMENT
—	Round Rose	N/C
SR	Square Rose (Function 211)	\$10.00
	Square Rose (Function 115,116,126,176)	\$20.00



ROUND ROSE



SQUARE ROSE

SF SERIES
CYLINDRICAL LOCKS

Levers



PHILADELPHIA



BOSTON



MIAMI



MEMPHIS



ORLANDO

CYLINDER OPTIONS	ICON	LOCK ADJUSTMENT
D		N/C
SFL		

IC Core not included see page 83 for core options.



Non-Fire Rated Adjustable Latch (Standard on Non-Keyed Functions)

CODE	DESCRIPTION	LOCK ADJUSTMENT
ADJ	Adjustable non-fire rated latch, 1" face width with 1/4" radius corner with 1-1/8" square corner filler	N/C
234	Fixed 2-3/4" backset fire rated latch, Square Corner 1-1/8" face	\$9.00
238	Fixed 2-3/8" backset fire rated latch, Square Corner 1" face	
238R	Fixed 2-3/8" backset fire rated latch, Radius Corner 1" face	

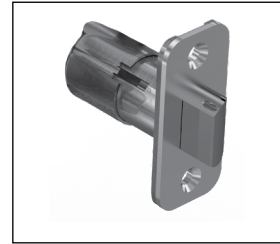

Non-Fire Rated Adjustable Latch

UL Fire Rated Fixed Backset Option for Non-Keyed Functions*

CODE	DESCRIPTION	LOCK ADJUSTMENT
234	Fixed 2-3/4" backset fire rated latch, Square Corner 1-1/8" face	N/C
238	Fixed 2-3/8" backset fire rated latch, Square Corner 1" face	\$9.00
238R	Fixed 2-3/8" backset fire rated latch, Radius Corner 1" face	



Fire Rated Fixed Latch

*Standard on Keyed Functions, BHMA Certified.

Strikes

	CODE	DESCRIPTION	LOCK ADJUSTMENT
	ASA	ASA Strike (any finish) 1-1/4" x 4-7/8"	N/C
	T	T-Strike (any finish) 1-1/8" x 2-3/4"	
	FL	Full Lip Strike (any finish) 1-5/8" x 2-1/4"	

NOTES:

- Specify finish for Strikes & Latchbolts if ordered separately

Options

CODE	DESCRIPTION	LOCK ADJUSTMENT
SF	Split Finishes (Added to highest finish price)	\$8.00

Strike Parts

	CODE	DESCRIPTION	605	613E	619	622	625	630	PART LIST PRICE
	ASA	ASA Strike (any finish) 1-1/4" x 4-7/8"	V91900-5	V91900-6	V91900-E	V91900-H	V91900-2	V91900-1	\$38.00
	T	T-Strike (any finish) 1-1/8" x 2-3/4"	V91901-5	V91901-6	V91901-E	V91901-H	V91901-2	V91901-1	\$17.00
	FL	Full Lip Strike (any finish) 1-5/8" x 2-1/4"	V919010-5	V919010-6	V919010-E	V919010-H	V919010-2	V919010-1	\$14.00

Cylinders

PDQ KEYWAY	COMPATIBLE WITH	SOLD WITH LOCK	
AR1	Arrow / AR1	N/C	
CO59A1	Corbin / 59A1		
CO6	Corbin / 60		
CL4	Corbin / L4		
RUD	Russwin / D1		
SCE	Schlage / E		
SCC	Schlage / C		
SCC-K	Schlage / C-K		
SAL	Sargent / LA		
RA-RC	Sargent / RA-RC		
YA8	Yale / E1R		
GA	Yale / GA		
FAL	Falcon / E-R		
KW	Kwikset		
TA	PDQ / TA (Restricted. Limited to Grandmaster systems w/4 masters)		
Dummy	—		
T-Turn	—		
L	Less Cylinder		Deduct \$4.00
HIGH SECURITY CYLINDERS AND CORES			
SEE HIGH SECURITY CYLINDERS AND CORES SECTION, PAGE 118			

NOTES:

- Specify finish for cylinders ordered separately
- Kwikset cylinder available in 5 pin only
- Specify KD, KA4, or 1 bitted
- 6 pin cylinder keyed for 5 pin

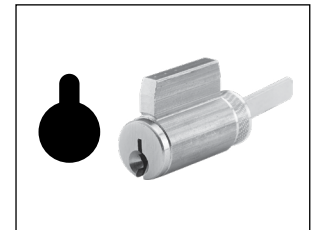

Key in Knob/Lever Cylinder



UL 437 and High Security Cylinders

Cores and Keyways

DESCRIPTION	PDQ NO.	ADD
SMALL FORMAT UNCOMBINATED		
6 Pin Cores	I5206 + KEYWAY	\$40.00
7 Pin Cores	I5207 + KEYWAY	
COMBINATED		
6 Pin Cores	I5206-1 + KEYWAY	\$60.00
7 Pin Cores	I5207-1 + KEYWAY	
BEST™ Compatible		
A (DEFAULT), B, C, D, E, F, G, H, J, K, L, M, Q, WA, WB, WC, WG, WH, TB, TD, TE, & R		
PDQ Exclusive		
PDQ1, PDQ2		
PDQ Exclusive and Restricted		
PDQ3		
SFIC CONSTRUCTION		
Construction Core 6-pin only		\$60.00
Dummy Construction Core Plastic		\$8.00
HIGH SECURITY IC CORES		
SEE HIGH SECURITY CYLINDERS AND CORES SECTION, PAGE 118.		



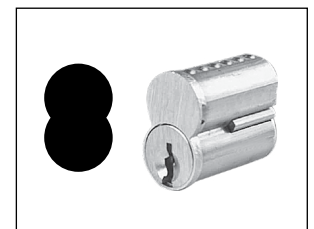

NOTES:

- Specify finish for IC Cores ordered separately
- Control keys must be ordered separately
- **PDQ1, PDQ2, PDQ3 (Restricted)**, Best A2 & A4 Systems Available



SFL/SFIC Core

PDQ Functions

FUNCTION	FUNCTION NUMBER	INSIDE OUTSIDE	DESCRIPTION	ANSI NUMBER
NON KEYED				
Passage	SF126		<ul style="list-style-type: none"> Latchbolt operated by lever from either side at all times 	F75
Privacy Bedroom Bathroom	SF176		<ul style="list-style-type: none"> Latchbolt operated by lever from either side or emergency release in outside lever Outside lever locked by push button on inside Outside lever unlocked by emergency release from outside, rotating inside lever, or closing door 	F76
KEYED				
Storeroom	SF115	 Fixed backset, fire rated, BHMA latch included.	<ul style="list-style-type: none"> Latchbolt operated from outside by key, inside by lever Outside lever always fixed Inside lever always free Deadlocking (guarded) latchbolt 	F86
Entrance	SF116	 Fixed backset, fire rated, BHMA latch included.	<ul style="list-style-type: none"> Latchbolt operated by lever from either side or key in outside lever Outside lever locked by push/turn button on inside When outside lever is locked by push button on inside – key from outside, or rotating inside lever unlocks outside lever When outside lever is locked by pushing and turning the button on the inside, key from outside or rotating inside lever retracts latch but does not unlock outside lever Deadlocking (guarded) latchbolt 	F109
DUMMY				
Single Dummy	SF211		<ul style="list-style-type: none"> Pull lever one side No mechanical operation 	—



INDICATES RIGID LEVER

Lever Cross Reference

PDQ	ARROW	CORBIN	DORMA	FALCON	HAGER	SARGENT	SCHLAGE	YALE
MIAMI — MIA		AZD	LG			B	JAZ	MO
PHILADELPHIA — PHL	BRR	NZD	LR	D	WTS	L	ELA	AU
BOSTON — BSN	SR	PZD	LC	Q	ARC	P		PB
MEM — MEMPHIS								
ORL — ORLANDO							LAT	



PHILADELPHIA — PHL



BOSTON — BSN



MIAMI — MIA



MEMPHIS — MEM



ORLANDO — ORL



ALL LEVERS

Information on this sheet is compiled from public documents and third parties. As a result, PDQ makes no guarantees as to their accuracy, content, quality or availability. Comparisons were made using the technical features only and are not commercial comparisons. Final suitability should be determined by a professional hardware consultant.

Typical Applications

- Assisted Living
- Hospitality
- Military Housing
- Multi-family
- Offices
- Retail

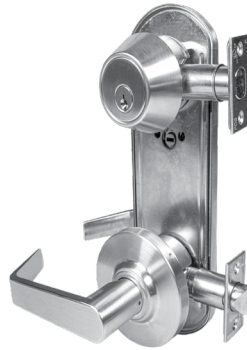



Specifications

FOR DOORS:	• 1-3/8" and 1-3/4" thick.
PREPARATION:	• ANSI/BHMA A156.115 for 4" and 5-1/2" hole centers, field selectable.
DUST BOX:	• Included for Latchbolt and Deadbolt.
LATCHBOLT BACKSET:	• 2-3/8" or 2-3/4" (Default). Specify when ordering
DEADBOLT BACKSET:	• Field adjustable for 2-3/8" and 2-3/4" (Default).
STRIKE:	• "T"-Strike (Default) • ASA or Full-Lip optional
LEVERS:	• Boston, Miami, Memphis, Orlando, Philadelphia
ROSE:	• 2-3/8" Round Rose, 2-15/16" Square Rose
INSIDE ESCUTCHEON:	• 3-3/4"W x 9-3/4"H (Wrought)
LATCHBOLT:	• 1/2" Throw
DEADBOLT:	• 1" Throw • Brass Bolt containing one 1/4" case-hardened Steel Roll Pin
HANDING:	• Non-handed (Except for Memphis Lever)
KEYS:	• Two (2) per Lock
KEYWAYS:	• SCC Default (Schlage C Compatible). For additional keyways, see Cylinders and Keying section.
INTERCHANGEABLE CORE:	• 6-pin or 7-pin • Compatible with Best SFIC. • Not available in high security.
CONVENTIONAL KEY IN KNOB/LEVER CYLINDER:	• 6-pin Cylinder keyed to 5-pins
KEYING:	• Options: MK, CMK, or GMK, Zero Bitted (KO), Keyed Different (KD) or Keyed Alike (KA) • Can be keyed into existing master key systems. See Keyways Section.
FINISHES:	• 605 (US3), 613E, 622 (US19), 626 (US26D) * OTHER FINISHES AVAILABLE. CONTACT CUSTOMER SERVICE FOR QUOTE AND LEAD-TIME.
CERTIFICATIONS, LISTINGS, COMPLIANCES:	• ANSI, Grade 2 • UL listed for 3 hrs, for single doors up to 4'0" x 8'0" • Complies with ADA (Americans with Disabilities Act) and ICC/ANSI 117.1 for Accessible and Usable Buildings • TAA compliant. Country of origin: KR
WARRANTY:	• Two (2) year Limited Warranty

How to Order

QUANTITY	TYPE	FUNCTION	LEVER	ROSE	FINISH	BACKSET	HANDING	STRIKE	CYLINDER	KEYWAY	OPTION
6	CL	116	PHL	—	626	234	—	FL	D	SCC	—
			MIA — Miami	BLANK — Round Rose (default)	605	238 — 2-3/8"	LH — Left Hand	ASA — ASA	D Default	PAGE 89	DB — Dust Box
			PHL — Philadelphia	(default) All Levers	613E	234 — 2-3/4"	RH — Right Hand	FL — Full Lip	L Less Cylinder		
			BSN — Boston	SR — Square Rose (Orlando Lever Only)	622			T — "T" Strike (default)	SF6 Lock is SFIC prepped w/ 6 pin core		
			MEM — Memphis		626				SF7 Lock is SFIC prepped w/ 7 pin core		
			ORL — Orlando						SFL Lock is SFIC prepped but less core		
									SFC Lock is SFIC prepped w/ construction core		
									SFP Lock is SFIC prepped w/ plastic construction core		
						PAGE 90		PAGE 88	PAGE 89		PAGE 90

ANSI NO.	FUNCTION	DESCRIPTION	626	605/613E 622
NON-KEYED				
	176	Passage Lever with Deadbolt Indicator	\$362.00	\$384.00
SINGLE CYLINDER				
F95	126	Entrance, Passage Lever	\$444.00	\$466.00
DOUBLE CYLINDER				
F98	115	Storeroom, Privacy Lever	\$463.00	\$485.00
F97	116	Entrance, Privacy Lever		
List prices shown include conventional key in knob/lever cylinder.				

CYLINDER OPTIONS	ICON	LOCK ADJUSTMENT
D		N/C
SFL		

IC Core not included see page 89 for core options

NOTES:

- Prices do not include IC Cores
- Locks will be furnished with 2-3/4" Backset, T-Strike & SCC Keyway unless otherwise stated
- 2-3/4" Latchbolt will be furnished with 2-1/4" x 1-1/8" faceplate unless otherwise stated
- 2-3/8" Latchbolt will be furnished with 2-1/4" x 1" faceplate unless otherwise stated

Trim

CODE	DESCRIPTION	LOCK ADJUSTMENT
—	Round Rose	N/C
SR	Square Rose	\$20.00

CL SERIES

LIST PRICE
Effective July 3, 2023

Lever Designs

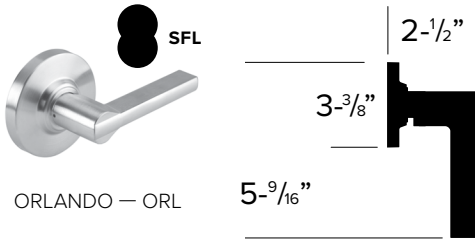
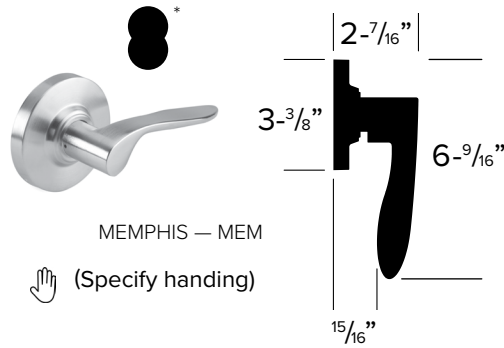
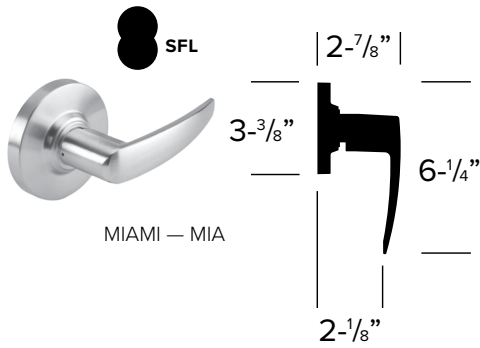
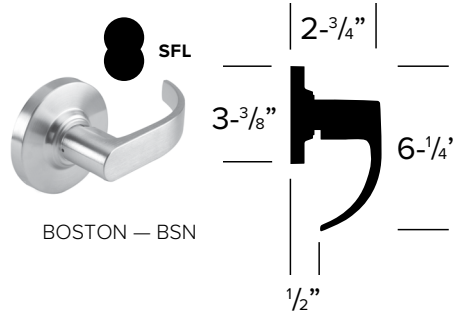
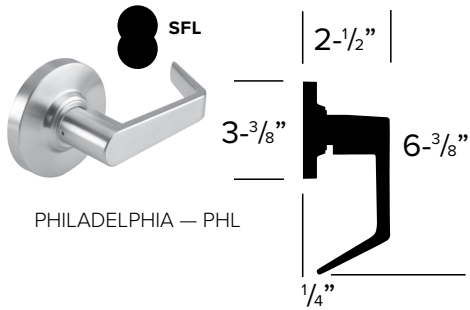

ALL LEVERS

* Small Format with MEM lever is only available in non-keyed, and single cylinder configurations.

Trim Designs

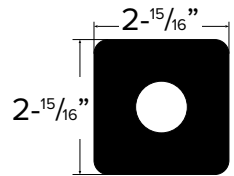

Dimensions

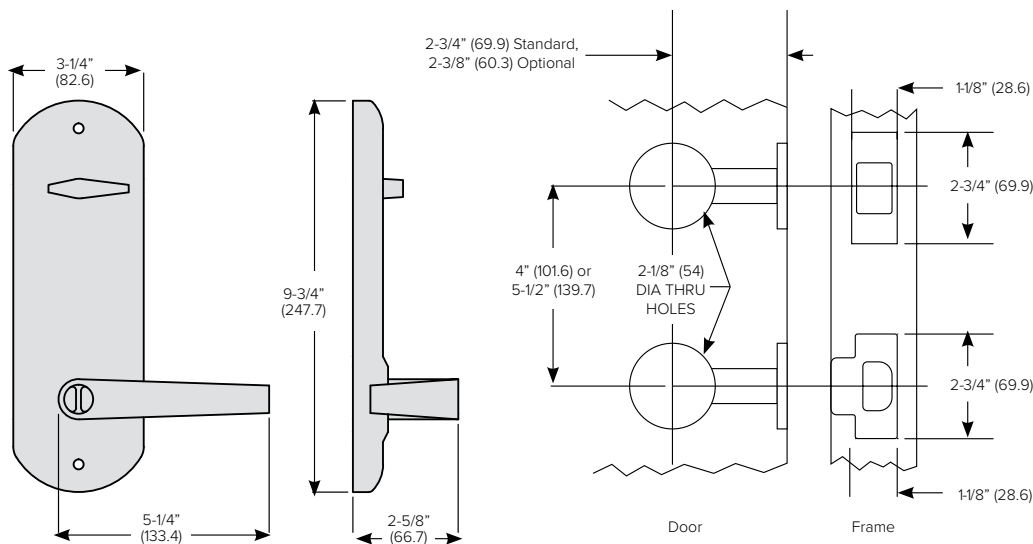

Note: Dimensions in parenthesis in millimeters

Note: Fits ANSI/BHMA 156.115 door preparation for Interconnected Locks

Latchbolts

CODE	BACKSET	FACEPLATE	CORNERS	LOCK ADJUSTMENT
238	2-3/8"	2-1/4" X 1	SQUARE (DEFAULT)	N/C
238F		2-1/4" X 1-1/8"	SQUARE	
238R		2-1/4" X 1	1/4" RADIUS	
238	2-3/4"	2-1/4" X 1	SQUARE (DEFAULT)	
238F		2-1/4" X 1-1/8"	SQUARE	
238R		2-1/4" X 1	1/4" RADIUS	
234F	2-3/4"	2-1/4" X 1	SQUARE	
234		2-1/4" X 1-1/8"	SQUARE (DEFAULT)	
234F		2-1/4" X 1	SQUARE	
234		2-1/4" X 1-1/8"	SQUARE (DEFAULT)	
234R		2-1/4" X 1-1/8"	1/4" RADIUS	

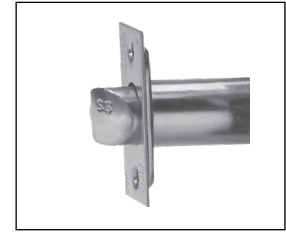

Dead Latch



Springlatch

Strikes

	CODE	DESCRIPTION	LOCK ADJUSTMENT
	ASA	ASA Strike (any finish) 1-1/4" x 4-7/8"	N/C
	T	T-Strike (any finish) 1-1/8" x 2-3/4"	
	FL	Full Lip Strike (any finish) 1-5/8" x 2-1/4"	

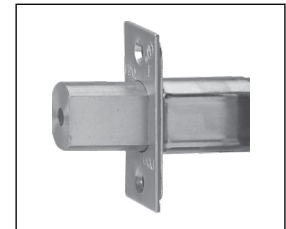

Deadbolt

Note 1 - Dust Boxes for Deadbolt and Latchbolt included with the lock.

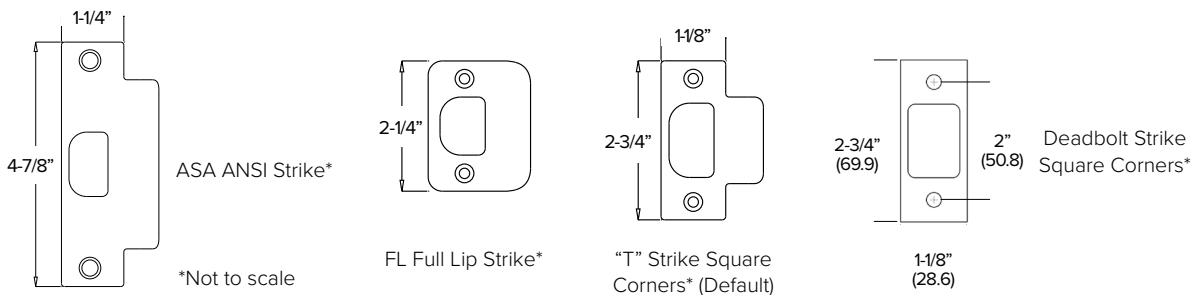

Keyways and Cylinders

PDQ KEYWAY	COMPATIBLE WITH	SOLD WITH LOCK	
AR1	Arrow / AR1	N/C	
CO59A1	Corbin / 59A1		
CO6	Corbin / 60		
CL4	Corbin / L4		
RUD	Russwin / D1		
SCE	Schlage / E		
SCC	Schlage / C		
SCC-K	Schlage / C-K		
SAL	Sargent / LA		
RA-RC	Sargent / RA-RC		
YA8	Yale / EIR		
GA	Yale / GA		
FAL	Falcon / E-R		
KW	Kwikset		
TA	PDQ / TA (Restricted. Limited to Grandmaster systems w/4 masters)		
Dummy	—		
T-Turn	—		
L	Less Cylinder		Deduct \$4.00

NOTES:

- Specify finish for cylinders ordered separately
- Kwikset cylinder available in 5 pin only
- Specify KD, KA4, or 1 bitted
- 6 pin cylinder keyed for 5 pin

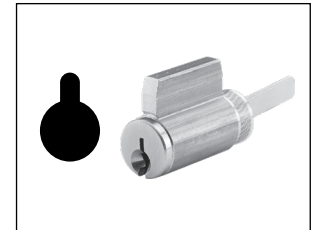

Key in Knob/Lever Cylinder

Cores and Keyways

DESCRIPTION	PDQ NO.	ADD
UNCOMBINED		
6 Pin Cores	I5206 + KEYWAY	\$40.00
7 Pin Cores	I5207 + KEYWAY	
COMBINED		
6 Pin Cores	I5206-1 + KEYWAY	\$60.00
7 Pin Cores	I5207-1 + KEYWAY	
BEST Compatible		
A (DEFAULT), B, C, D, E, F, G, H, J, K, L, M, Q,		
WA, WB, WC, WG, WH, TB, TD, TE, & R		
PDQ Exclusive		
PDQ1, PDQ2		
PDQ Exclusive and Restricted		
PDQ3		
SFIC CONSTRUCTION		
Construction Core 6-pin only		\$60.00
Dummy Construction Core Plastic		\$8.00

NOTES:

- Specify finish for IC Cores ordered separately
- Control keys must be ordered separately
- **PDQ1, PDQ2, PDQ3 (Restricted)**, Best A2 & A4 Systems Available

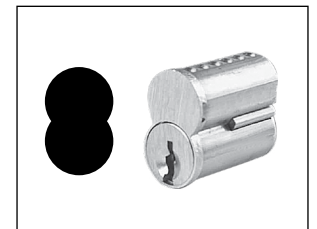

SFL/SFIC Core

Options

CODE	DESCRIPTION	LOCK ADJUSTMENT
DB	Dust Box	\$8.00

Backset

BACKSET	TYPE	FACEPLATE	CORNERS	PDQ NUMBER	PART LIST PRICE
2-3/8"	SPRINGLATCH	2-1/4" X 1	SQUARE (DEFAULT)	V21900-722	\$68.00
		2-1/4" X 1-1/8"	SQUARE	V21900-724	
		2-1/4" X 1	1/4" RADIUS	V21900-722R	
	DEADLATCH	2-1/4" X 1	SQUARE (DEFAULT)	V21900-721	
		2-1/4" X 1-1/8"	SQUARE	V21900-723	
		2-1/4" X 1	1/4" RADIUS	V21900-721R	
		ADJUSTABLE	2-1/4" X 1	SQUARE (DEFAULT)	
2-1/4" X 1	1/4" RADIUS		I04507R		
2-3/4"	SPRINGLATCH	2-1/4" X 1	SQUARE	V21900-714	
		2-1/4" X 1-1/8"	SQUARE (DEFAULT)	V21900-712	
	DEADLATCH	2-1/4" X 1	SQUARE	V21900-713	
		2-1/4" X 1-1/8"	SQUARE (DEFAULT)	V21900-711	

Deadbolts

BACKSET	TYPE	FACEPLATE	CORNERS	PDQ NUMBER	LIST PRICE
2-3/8" AND 2-3/4"	ADJUSTABLE	2-1/4" X 1	SQUARE (DEFAULT)	I04507	\$52.00
		2-1/4" X 1	1/4" RADIUS	I04507R	
2-3/4" (DEFAULT)	FIXED	2-1/4" X 1-1/8"	SQUARE	I04510	

Strikes

	CODE	DESCRIPTION	605	613E	622	630	LIST PRICE
	ASA	ASA Strike (any finish) 1-1/4" x 4-7/8"	V91900-5	V91900-6	V91900-H	V91900-7	\$38.00
	T	T-Strike (any finish) 1-1/8" x 2-3/4"	V91901-5	V91901-6	V91901-H	V91901-7	\$17.00
	FL	Full Lip Strike (any finish) 1-5/8" x 2-1/4"	V919010-5	V919010-6	V919010-H	V919010-7	\$14.00
	W	Deadbolt Strike	I4072-5	I4072-6	I4072-H	I4072-7	

PDQ Functions

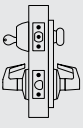
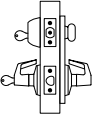
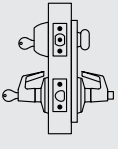
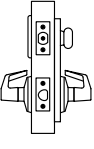
FUNCTION	FUNCTION NUMBER	OUTSIDE INSIDE	DESCRIPTION	ANSI NUMBER
Entry Single Cylinder Passage Lever	126		<ul style="list-style-type: none"> • Outside and Inside lever always free • Deadbolt projected or retracted by key outside or turnpiece inside • When deadbolt is projected, turning inside knob/lever retracts deadbolt and latchbolt simultaneously 	F95
Storeroom Double Cylinder (See note) Passage Lever	115		<ul style="list-style-type: none"> • Deadlocking latch bolt is operated by key outside or inside lever • Key outside projects or retracts dead bolt. • Operating inside lever or keys outside retracts dead bolt and deadlocking latch. 	F98
Entry Double Cylinder (See note) Privacy Lever	116		<ul style="list-style-type: none"> • Outside lever locked by turn button in inside knob/lever • Inside lever always free • Unlocking of outside lever requires use of key or manual return of inside turn button • Deadbolt is activated by key in outside deadlock or turnpiece inside • Turning inside lever retracts deadbolt and latchbolt simultaneously 	F97
Privacy with Dead Bolt Indicator No Cylinder Passage Lever	176		<ul style="list-style-type: none"> • Outside and Inside lever always free • Indicator outside • Thumbturn inside extends/retracts deadbolt • Emergency key outside retracts deadbolt • When deadbolt is projected, turning inside lever retracts deadbolt and latchbolt simultaneously 	—

Cross Reference

ANSI NUMBER / FUNCTION	PDQ	CAL-ROYAL	DORMA	FALCON	HAGER	SCHLAGE	STANLEY	YALE
95 / ENTRY, SINGLE CYLINDER	CL 126	HIL00, JHIL00	J310	—	3710	CS/RS 210 SERIES	QC1230 SERIES	4851LN
97 / ENTRY, DOUBLE CYLINDER	CL 116	HIL30, JHIL30	J353	H101DG	3753	CS/RS 250 SERIES	QC1250 SERIES	4871LN
98 / STOREROOM, DOUBLE CYLINDER	CL 115	—	—	—	—	CS/RS 280 SERIES	QC1285 SERIES	—
PRIVACY W/INDICATOR, NO CYLINDER	CL 176	—	—	—	—	—	QC1285 SERIES	—

Information on this sheet is compiled from public documents and third parties. As a result, PDQ makes no guarantees as to their accuracy, content, quality or availability. Comparisons were made using the technical features only and are not commercial comparisons. Final suitability should be determined by a professional hardware consultant.

Typical Applications

- Apartments
- Back-of-House Hotel/Motel
- Heavy-Duty Residential
- Houses of Worship
- Medium Traffic Commercial Applications
- Offices
- Retail Backroom
- Retrofit/Repair/Replacement
- Warehouses

Features

- UL listed for 3-hour fire door
- ANSI/BHMA A156.2 Grade 2
- 9 standard functions
- Various strike and latch options to accommodate any opening
- Available in keyways of most major manufacturers
- Tactile abrasive coating option
- Antimicrobial coating option
- One (1) year limited warranty



Specifications





FOR DOORS:	• 1-3/8" to 1-3/4" thick
BACKSET:	• 2-3/4" standard • 2-3/8", 5" optional
FRONT:	• 2-1/4" x 1-1/8" or 2-1/4" x 1" • Stainless Steel or Wrought Brass
STRIKE:	• 4-7/8" x 1-1/4" (ASA). "T" or "FL" Strike optional. Stainless steel or wrought bronze.
ROSE:	• 3" DIA Wrought
LATCHBOLT:	• 1/2" throw. Solid brass. Adjustable for beveled doors.
HAND:	• Non-handed
KEYS:	• Two change keys per lock.
KEYWAYS:	• Available in keyways of most major manufacturers.
CYLINDER:	• Brass 6-pin cylinder keyed to 5 pins. • Standard High Security and UL437 Cylinders Available
TRIM:	• Stainless Steel or Wrought Brass Knobs and Roses
KEYING:	• Can be MK, CMK, GMK, or CK. Available Zero Bitted (KO), Keyed Different (KD), Keyed Alike (KA). Can be keyed into existing masterkey systems of other manufacturers.
FINISHES:	• 630 (US32D) • Optional Antimicrobial Coating available
WARRANTY:	• One (1) Year Limited Warranty
CERTIFICATIONS, LISTINGS, COMPLIANCES:	• Certified to ANSI/BHMA A156.2, Grade 2 • UL/CUL 10C listed for 3 hrs, for single doors up to 4'0" x 8'0" • TAA compliant. Country of origin: KR

How to Order

QUANTITY	SERIES	FUNCTION	KNOB	FINISH	BACKSET	STRIKE	CYLINDER	KEYWAY	KEYING
20	SV	116	CQ	630	234	ASA	D	SCC	KD
				605 613E	234 — 2-3/4" 238 — 2-3/8" 334 — 3-3/4" 5 — 5"	ASA — ANSI/ ASA (default) FL — Full Lip T — "T" Strike See page 94	D Default L Less Cylinder SF6 Lock is SFIC prepped w/ 6 pin core SF7 Lock is SFIC prepped w/ 7 pin core SFL Lock is SFIC prepped but less core SFC Lock is SFIC prepped w/ construction core SFP Lock is SFIC prepped w/ plastic construction core	PAGE 95	
						PAGE 94	PAGE 95		

NOTE: Case quantity is 20 / Case weight is 43 lbs. Keyed Functions / Case weight is 40 lbs. Non-Keyed Functions / For split finishes, designate O/S trim first, then I/S

ANSI NO.	FUNCTION	DESCRIPTION	630	605/613E
NON-CYLINDER				
	125	Communicating	\$100.00	\$109.00
F75	126	Passage		
F76	176	Privacy	\$104.00	\$113.00
SINGLE CYLINDER				
F86	115	Store Room	\$122.00	\$131.00
F109	116	Entrance		
F84	148	Classroom		
DOUBLE CYLINDER				
F91	137	Store Door	\$180.00	\$189.00
DUMMY				
	205	Double Dummy	\$90.00	\$99.00
	211	Single Dummy	\$54.00	\$63.00
List prices shown include conventional key in knob/lever cylinder. For I-C, list prices do not include core.				

CYLINDER OPTIONS	ICON	LOCK ADJUSTMENT
D		N/C
SFL		

NOTES:

- Locks will be furnished with 2-3/4" Latchbolt, ASA Strike & SCC Key way unless otherwise stated
- 2-3/4" Latchbolt will be furnished with 2-1/4" x 1-1/8" faceplate unless otherwise stated
- 2-3/8" Latchbolt will be furnished with 2-1/4" x 1" faceplate unless otherwise stated

Trim



BALL KNOB - CQ

SV SERIES

LIST PRICE

Effective July 3, 2023

CODE	DESCRIPTION	LOCK ADJUSTMENT
2-3/4" BACKSET		
234	2-1/4" x 1-1/8"	N/C
234F	2-1/4" x 1"	
234FR	2-1/4" x 1" x 1/4" Radius	
2-3/8" BACKSET		
238F	2-1/4" x 1-1/8"	N/C
238	2-1/4" x 1"	
238R	2-1/4" x 1" x 1/4" Radius	
3-3/4" BACKSET		
334F	2-1/4" x 1-1/8"	\$18.00
334	2-1/4" x 1"	
334R	2-1/4" x 1" x 1/4" Radius	
5" BACKSET		
5	2-1/4" x 1-1/8"	\$24.00
5F	2-1/4" x 1"	
5FR	2-1/4" x 1" x 1/4" Radius	



Latchbolt



Deadlatch

Strikes

	CODE	DESCRIPTION	LOCK ADJUSTMENT
	ASA	ASA Strike (any finish) 1-1/4" x 4-7/8"	N/C
	T	T-Strike (any finish) 1-1/8" x 2-3/4"	
	FL	Full Lip Strike (any finish) 1-5/8" x 2-1/4"	

NOTES:

- Specify finish for Strikes & Latchbolts if ordered separately

Keyways and Cylinders

PDQ KEYWAY	COMPATIBLE WITH	SOLD WITH LOCK	
AR1	Arrow / AR1	N/C	
CO59A1	Corbin / 59A1		
CO6	Corbin / 60		
CL4	Corbin / L4		
RUD	Russwin / D1		
SCE	Schlage / E		
SCC	Schlage / C		
SCC-K	Schlage / C-K		
SAL	Sargent / LA		
RA-RC	Sargent / RA-RC		
YA8	Yale / E1R		
GA	Yale / GA		
FAL	Falcon / E-R		
KW	Kwikset		
TA	PDQ / TA (Restricted. Limited to Grandmaster systems w/4 masters)		
Dummy	—		
T-Turn	—		
L	Less Cylinder		Deduct \$4.00
HIGH SECURITY CYLINDERS AND CORES			
SEE HIGH SECURITY CYLINDERS AND CORES SECTION, PAGE			

NOTES:

- Specify finish for cylinders ordered separately
- Kwikset cylinder available in 5 pin only
- Specify KD, KA4, or 1 bitted
- 6 pin cylinder keyed for 5 pin

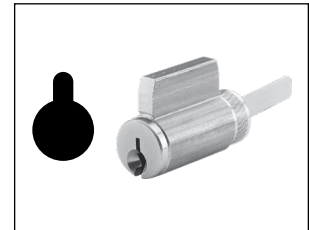

Key in Knob/Lever Cylinder



UL 437 and High Security Cylinders

Cores and Keyways

DESCRIPTION	PDQ NO.	ADD
SMALL FORMAT UNCOMBINATED		
6 Pin Cores	I5206 + KEYWAY	\$40.00
7 Pin Cores	I5207 + KEYWAY	
COMBINATED		
6 Pin Cores	I5206-1 + KEYWAY	\$60.00
7 Pin Cores	I5207-1 + KEYWAY	
BEST[™] Compatible		
A (DEFAULT), B, C, D, E, F, G, H, J, K, L, M, Q,		
WA, WB, WC, WG, WH, TB, TD, TE, & R		
PDQ Exclusive		
PDQ1, PDQ2		
PDQ Exclusive and Restricted		
PDQ3		
SFIC CONSTRUCTION		
Construction Core 6-pin only		\$60.00
Dummy Construction Core Plastic		\$8.00
HIGH SECURITY IC CORES		
SEE HIGH SECURITY CYLINDERS AND CORES SECTION, PAGE 118. — LFIC REQUIRES LARGE FORMAT LEVER		

NOTES:

- Specify finish for IC Cores ordered separately
- Control keys must be ordered separately
- **PDQ1, PDQ2, PDQ3 (Restricted)**, Best A2 & A4 Systems Available

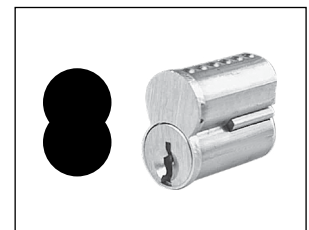

SFL/SFIC Core

SV SERIES PARTS

LIST PRICE

Effective July 3, 2023

Backset

CODE	TYPE	FACEPLATE	CORNERS	PDQ NUMBER	LIST PRICE	
2-3/4" BACKSET						
234F	SPRINGLATCH	2-1/4" X 1	SQUARE	V21900-714	\$68.00	
234		2-1/4" X 1-1/8"	SQUARE (DEFAULT)	V21900-712		
234F	DEADLATCH	2-1/4" X 1	SQUARE	V21900-713		
234		2-1/4" X 1-1/8"	SQUARE (DEFAULT)	V21900-711		
2-3/8" BACKSET						
238	SPRINGLATCH	2-1/4" X 1	SQUARE (DEFAULT)	V21900-722		
238F		2-1/4" X 1-1/8"	SQUARE	V21900-724		
238R		2-1/4" X 1	1/4" RADIUS	V21900-722R		
238	DEADLATCH	2-1/4" X 1	SQUARE (DEFAULT)	V21900-721		
238F		2-1/4" X 1-1/8"	SQUARE	V21900-723		
238R		2-1/4" X 1	1/4" RADIUS	V21900-721R		
3-3/4" BACKSET EXTENSION						
Extension for 2-3/8" latch (sold separately) to make 3-3/4" Backset.				V21903	\$55.00	
5" BACKSET EXTENSION						
Extension for 2-3/4" latch (sold separately) to make 5" Backset.				V21902		

Strikes

	CODE	DESCRIPTION	605	613E	630	LIST PRICE
	ASA	ASA Strike (any finish) 1-1/4" x 4-7/8"	V91900-5	V91900-6	V91900-1	\$38.00
	T	T-Strike (any finish) 1-1/8" x 2-3/4"	V91901-5	V91901-6	V91901-1	\$17.00
	FL	Full Lip Strike (any finish) 1-5/8" x 2-1/4"	V919010-5	V919010-6	V919010-1	\$14.00

PDQ Functions

FUNCTION	FUNCTION NUMBER	INSIDE OUTSIDE	DESCRIPTION	ANSI NUMBER
NON KEYED				
Closet/ Communicating	SV125		<ul style="list-style-type: none"> Blank plate outside Inner knob always free Deadlocking (guarded) latchbolt 	—
Passage	SV126		<ul style="list-style-type: none"> Latchbolt operated by both knobs 	F75
Privacy Bedroom Bathroom	SV176		<ul style="list-style-type: none"> Latchbolt operated by both knobs Push button in inside knob locks outside knob Inside knob or closing door releases button Emergency opening from outside 	F76
KEYED				
Storeroom	SV115		<ul style="list-style-type: none"> Latchbolt operated from outside by key, inside by knob Outside knob is rigid at all times Inside knob always free for immediate exit 	F86
Entrance	SV116		<ul style="list-style-type: none"> Latchbolt operated by both knobs Outside knob locked or unlocked by turn/push button Inside knob always free Pushing and turning button locks outside knob requiring use of key until button is manually unlocked Pushing button only locks outside knob until unlocked with key or inside knob is turned 	F109
General Entrance	SV137		<ul style="list-style-type: none"> Latchbolt operated by both knobs Key on either side locks or unlocks 	—
Classroom Storage	SV148		<ul style="list-style-type: none"> Latchbolt operated from outside by knob except when locked from outside by key Latchbolt operated from inside by knob at all times 	F84
DUMMY				
Single Dummy	SV211		<ul style="list-style-type: none"> Single pull knob Single side surface No mechanical operation 	—
Double Dummy	SV205		<ul style="list-style-type: none"> Double pull knob Both sides No mechanical operation 2-1/8" bored hole 	—

INDICATES RIGID KNOB

Secure. Durable. Versatile.

Deadbolts are often paired with a cylindrical lock in commercial office spaces, residential applications and other spaces where there is a greater need for security—and, more specifically, a deadbolt that is more resistant to brute force attack. PDQ deadbolts provide security for a wide range of applications while allowing end users to meet their specific security needs.

KM

Heavy Duty Rim Cylinder
Mechanical



Applications

Heavy duty performance. Ideal for commercial, institutional, government, military, hospitality, hospital, multi-family, offices, and retail applications. Typical installations include storerooms, auxiliary entrance locks, communication doors in hotels, and aluminum storefronts.

KT

Extra Heavy Duty
Mortise Cylinder



Applications

Heavy duty performance. Ideal for commercial, institutional, government, military, hospitality, hospital, multi-family, offices, and retail applications.

KV

Commercial Duty
Rim Cylinder



Applications

Standard duty performance, ideal for light commercial and residential applications.

MJ

Extra Heavy Duty
Mortise Cylinder



Applications

Small body deadbolt provides an extra measure of protection at a competitive price. Uses include common areas, auxiliary doors, closets, storerooms, and equipment rooms in commercial, institutional and military applications.

Typical Applications

- Commercial
- Government
- Hospitality
- Institutional
- Military
- Multi-family
- Offices
- Retail



Deadbolt is Grade Comparable with GP and SD Series Grade 2 Cylindrical Locks

Specifications



ADA COMPLIANT

FOR DOORS:	• 1-3/8" to 1-3/4" thick for Conventional Cylinder, 1-1/2" to 2" for SFIC
DOOR PREP:	• 2-1/8" DIA
BACKSET:	• 2-3/4" - 2-3/8" adjustable (Default) • 2-3/4" (Option)
FRONT:	• 2-1/4" x 1-1/8" (Default) • 2-1/4" x 1" faceplate available • Stainless Steel or Wrought Brass
STRIKE:	• 2-3/4" x 1-1/8" • Stainless Steel or Wrought Brass • Dust Box Included
DEADBOLT:	• 1" Throw • Brass Bolt containing one 1/4" case-hardened Steel Roll Pin
THUMBTURN:	• ADA Compliant
HAND:	• Non-handed
TRIM:	• Stainless Steel or Wrought Brass Scalp • Reinforced Diecast Rose
KEYS:	• Two (2) per Lock
KEYWAYS:	• SCC standard (Schlage C Compatible) • Also available in keyways of other manufacturers
INTERCHANGEABLE CORE:	• 6 or 7-pin • Compatible with Best, Falcon and Arrow
CYLINDER:	• 6-pin Brass Insert Cylinder keyed to 5-pins • Standard High Security and UL437 Cylinders Available
KEYING:	• Options: MK, CMK or GMK • Zero Bitted (KO), Keyed Different (KD) or Keyed Alike (KA) • Can be keyed into existing master key systems
FINISHES:	• 605 (US3), 606 (US4), 613E, 622 (US19), 626 (US26D), 630 (US32D)
CERTIFICATIONS, LISTINGS, COMPLIANCES:	• UL 10C listed, 3-hour fire rated as auxiliary locks for A label single doors • UL 10B listed for neutral pressure doors • Complies with ADA (Americans with Disabilities Act) and ICC/ANSI 117.1 for Accessible and Usable Buildings • TAA compliant. Country of origin: KR
WARRANTY:	• One (1) year Limited Warranty

PDQ Functions

KM SERIES
DEADBOLT LOCKS

FUNCTION	FUNCTION NUMBER	OUTSIDE INSIDE	DESCRIPTION	ANSI NUMBER
Single Cylinder	116		<ul style="list-style-type: none"> Lock or unlock by key from outside, by thumb turn from inside 	E1151
Double Cylinder	137		<ul style="list-style-type: none"> Lock or unlock by key from both sides 	E1141
Classroom	148		<ul style="list-style-type: none"> Lock or unlock by key from outside Turnpiece inside retracts deadbolt, but will not project it 	E1171

How to Order

QUANTITY	SERIES	FUNCTION	FINISH	BACKSET	CYLINDER	KEYWAY	KEYING
20	KM	116	630 605 606 613E 622 626 630	ADJ 234 — 2-3/4" 238 — 2-3/8" ADJ — Adjustable 2-3/4"—2-3/8"(Default)	D L SF6 SF7 SFL SFC SFP	SCC KD	
NOTE: Case quantity is 20 / Case weight varies							
				PAGE 101	PAGE 102	PAGE 102	

Deadbolts

ANSI NO.	FUNCTION	DESCRIPTION	626/630	605/606/613E 622
SINGLE CYLINDER				
E1151	116	Entrance	\$105.00	\$117.00
E1171	148	Classroom		
DOUBLE CYLINDER				
E1141	137	Store Door	\$130.00	\$142.00

List prices shown include conventional RIM cylinder. For I-C, list prices do not include core.

CYLINDER OPTIONS	ICON	LOCK ADJUSTMENT
D		N/C
SFL		

NOTES:

- Prices do not include IC Core

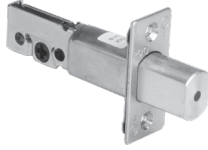

Backset

CODE	BACKSET DESCRIPTION	LOCK ADJUSTMENT
<i>2-3/8" Backset</i>		
238	2-1/4" x 1"	N/C
238R	2-1/4" x 1" x 1/4" Radius	\$5.00
<i>2-3/4" Backset</i>		
234	2-1/4" x 1-1/8" (Standard)	N/C
234R	2-1/4" x 1-1/8" x 1/4" Radius	\$5.00
<i>2-3/4" - 2-3/8" ADJUSTABLE</i>		
ADJ	2-1/4" x 1-1/8" (Standard)	N/C
ADJR	2-1/4" x 1-1/8" x 1/4" Radius	\$5.00

Keyways and Cylinders

KM SERIES
DEADBOLT LOCKS

PDQ KEYWAY	COMPATIBLE WITH	SOLD WITH LOCK	
ARA	Arrow / AR1	N/C	
CO59A1	Corbin / 59A1		
CO6	Corbin / 60		
CL4	Corbin / L4		
RUD	Russwin / D1		
SCE	Schlage / E		
SCC	Schlage / C		
SCC-K	Schlage / C-K		
SAL	Sargent / LA		
RA-RC	Sargent / RA-RC		
YAB	Yale / E1R		
GA	Yale / GA		
FAL	Falcon / E-R		
TA	PDQ / TA (Restricted. Limited to Grandmaster systems w/4 masters)		\$3.00
L	Less Cylinder		Deduct \$8/Cylinder

NOTES:

- Specify finish for Rim Cylinders ordered separately



Rim Cylinder



UL 437 and High Security Cylinders

Cores and Keyways

DESCRIPTION	PDQ NO.	ADD
UNCOMBINATED		
6 Pin Cores	I5206 + KEYWAY	\$40.00
7 Pin Cores	I5207 + KEYWAY	
COMBINATED		
6 Pin Cores	I5206-1 + KEYWAY	\$60.00
7 Pin Cores	I5207-1 + KEYWAY	
BEST[™] Compatible		
A (DEFAULT), B, C, D, E, F, G, H, J, K, L, M, Q,		
WA, WB, WC, WG, WH, TB, TD, TE, & R		
PDQ Exclusive		
PDQ1, PDQ2		
PDQ Exclusive and Restricted		
PDQ3		
SFIC CONSTRUCTION		
Construction Core 6-pin only		\$60.00
Dummy Construction Core Plastic Construction cores are invoiced at shipment and credited upon return.		\$8.00
HIGH SECURITY IC CORES		
SEE HIGH SECURITY CYLINDERS AND CORES SECTION, PAGE 118. — NOT AVAILABLE WITH LFIC		

NOTES:

- Combinated cores include master keying in the list price
- Specify finish for IC Cores ordered separately
- Control keys must be ordered separately
- **PDQ1, PDQ2, PDQ3 (Restricted)**, Best A2 & A4 Systems Available

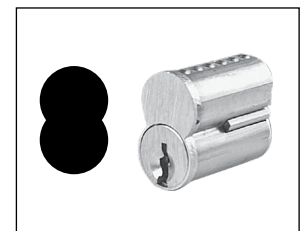

SFL/SFIC Core

KM SERIES PARTS

LIST PRICE
Effective July 3, 2023

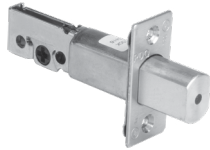

Backset

BACKSET DESCRIPTION	605	613E	622	630	LIST PRICE	
2-3/8" Backset						
2-1/4" x 1-1/8" (Default)	I04509-5	I04509-6	I04509-H	I04509-1	\$50.00	
2-1/4" x 1-1/8" x 1/4" Radius	I04509-5R	I04509-6R	I04509-H	I04509-1R		
2-3/4" Backset						
2-1/4" x 1-1/8" (Default)	I04510-5	I04510-6	I04510-H	I04510-1		
2-1/4" x 1-1/8" x 1/4" Radius	I04510-5R	I04510-6R	I04510-H	I04510-1R		
2-3/4" - 2-3/8" ADJUSTABLE						
2-1/4" x 1-1/8" (Default)	I04507-5	I04507-6	I04507-H	I04507-1		
2-1/4" x 1-1/8" x 1/4" Radius	I04507-5R	I04507-6R	I04507-H	I04507-1R		
1-1/8" Latch Front Filler Plate (Minimum of 100 pieces)	I099-100					\$5.00

KM SERIES
DEADBOLT LOCKS

Strikes

DESCRIPTION	605	613E	622	630	LIST PRICE
Deadbolt Strike 2-3/4" x 1-1/8"	I4702-5	I4702-6	I4702-H	I4702-1	\$25.00
Dust Box	I4701				\$8.00

Typical Applications

- Commercial
- Government
- Hospitality
- Institutional
- Military
- Multi-family
- Offices
- Retail



Deadbolt is Grade Comparable with XGT and GT Series Grade 1 Cylindrical Locks

Specifications



FOR DOORS:	• 1-3/4" thick standard, contact factory for other thicknesses
DOOR PREP:	• 2-1/8" DIA
BACKSET:	• 2-3/4" (Default) • 2-3/8" available
FRONT:	• 2-1/4" x 1-1/8" or 2-1/4" x 1" • Stainless Steel or Wrought Brass
STRIKE:	• 2-3/4" x 1-1/8" • Stainless Steel or Wrought Brass • Dust Box Included
DEADBOLT:	• 1" Throw • Brass Bolt containing two concealed 1/4" case-hardened Steel Roll Pins
HAND:	• Non-handed
TRIM:	• Wrought Brass Scalp • Reinforced Diecast Rose
KEYS:	• Two (2) per Lock
KEYWAYS:	• SCC standard (Schlage C Compatible) • Also available in keyways of other manufacturers
CYLINDER:	• 6-pin Brass Mortise Cylinder keyed to 5-pins, SFIC
KEYING:	• Options: MK, CMK or GMK • Zero Bitted (KO), Keyed Different (KD) or Keyed Alike (KA) • Can be keyed into existing master key systems
FINISHES:	• 605 (US3), 606 (US4), 612 (US10), 613E, 625 (US26), 626 (US26D)
WARRANTY:	• One (1) year Limited Warranty
LISTINGS:	• UL 10C listed, 3-hour fire rated as auxiliary locks for A label single doors • UL 10B listed for neutral pressure doors

PDQ Functions

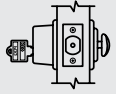
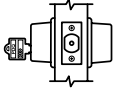
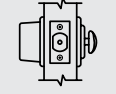
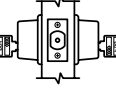
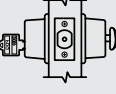
FUNCTION	FUNCTION NUMBER	OUTSIDE INSIDE	DESCRIPTION	ANSI NUMBER
Entrance	116		<ul style="list-style-type: none"> Lock or unlock by key from outside, by thumb turn from inside 	E1151
Single Cylinder	121		<ul style="list-style-type: none"> Lock or unlock by key from outside Blank mortise cylinder on inside 	E1161
Single Sided	125		<ul style="list-style-type: none"> Deadbolt by inside thumb turn only Blank mortise cylinder on outside 	E1112
Double Cylinder	137		<ul style="list-style-type: none"> Lock or unlock by key from both sides 	E1141
Classroom	148		<ul style="list-style-type: none"> Lock or unlock by key from outside Turnpiece inside retracts deadbolt, but will not project it 	E1171

How to Order

QUANTITY	SERIES	FUNCTION	FINISH	BACKSET	CYLINDER	KEYWAY	KEYING
10	KT	116	626	234	D	SCC	KD
NOTE: Case quantity is 10 / Case weight is 19 lbs. Single Cylinder / Case weight is 22 lbs. Double Cylinder / For split finishes, designate O/S trim first, then I/S				234 — 2-1/4" x 1-1/8" (Standard) 234R — 2-1/4" x 1-1/8" x 1/4" Radius 234D — Drive-in 238 — 2-1/4" x 1" 238R — 2-1/4" x 1" x 1/4" Radius 238D — Drive-in	D — Default L — Less Cylinder	PAGE 106	
				PAGE 106			

Deadbolts

ANSI NO.	FUNCTION	DESCRIPTION	626	605/606/612 613E/625
NON-CYLINDER				
E1112	125	Communicating	\$132.00	\$144.00
SINGLE CYLINDER				
E1151	116	Entrance	\$175.00	\$187.00
E1171	148	Classroom		
E1161	121	Blank Single Cylinder		
DOUBLE CYLINDER				
E1141	137	Store Door	\$185.00	\$197.00

NOTES:

- Consult Customer Service for availability of Split Finish
- 2-3/4" Latchbolt will be furnished with 2-1/4" x 1-1/8" faceplate unless otherwise stated
- 2-3/8" Latchbolt will be furnished with 2-1/4" x 1" face plate unless otherwise stated
- ADA thumbturn available special order

List prices shown include conventional key in knob/lever cylinder. For I-C, list prices do not include core.

Backset

CODE	BACKSET DESCRIPTION	LOCK ADJUSTMENT
<i>2-3/4" Backset</i>		
234	2-1/4" x 1-1/8" (Standard)	N/C
234R	2-1/4" x 1-1/8" x 1/4" Radius	\$5.00
234D	Drive-in	N/C
<i>2-3/8" Backset</i>		
238	2-1/4" x 1" (Standard)	N/C
238R	2-1/4" x 1" x 1/4" Radius	\$5.00
238D	Drive-in	N/C

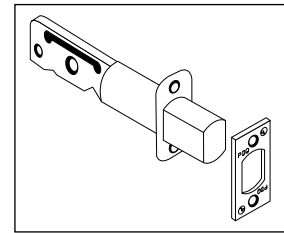

Bolt

KT SERIES
DEADBOLT LOCKS

Keyways and Mortise Cylinders

PDQ KEYWAY	COMPATIBLE WITH	SOLD WITH LOCK	
ARA	Arrow / AR1	N/C	
CO59A1	Corbin / 59A1		
CO6	Corbin / 60		
CL4	Corbin / L4		
RUD	Ruswin / D1		
SCE	Schlage / E		
SCC	Schlage / C		
SCC-K	Schlage / C-K		
SAL	Sargent / LA		
RA-RC	Sargent / RA-RC		
YA8	Yale / E1R		
GA	Yale / GA		
FAL	Falcon / E-R		
TA	PDQ / TA (Restricted. Limited to Grandmaster systems w/4 masters)		\$3.00
L	Less Cylinder		Deduct \$8/Cylinder

NOTES:

- Specify finish for Mortise Cylinders ordered separately



Mortise Cylinder

KT SERIES PARTS

LIST PRICE
Effective July 3, 2023

Backset

BACKSET DESCRIPTION	PDQ NO.	LIST PRICE	
2-3/4" Backset			
2-1/4" x 1-1/8" (Default)	I4301	\$50.00	
2-1/4" x 1-1/8" x 1/4" Radius	I4301R		
Drive-in	I4201-5		
2-3/8" Backset			
2-1/4" x 1" (Default)	I4302		
2-1/4" x 1" x 1/4" Radius	I4302R		
Drive-in	I4202-5		

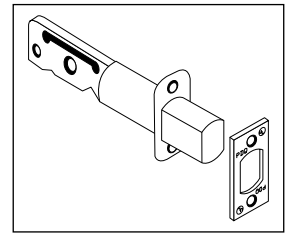

Bolt

KT SERIES
DEADBOLT LOCKS

Strikes

DESCRIPTION	605	613E	630	LIST PRICE
Deadbolt Strike 2-3/4" x 1-1/8"	I46021-5	I46021-6	I46021-1	\$25.00
Dust Box	I4587			\$8.00

Typical Applications

- Light Commercial Installations
- Low Security Applications
- Residential

Deadbolts are Grade Comparable with SD Series Grade 2 Cylindrical Locks

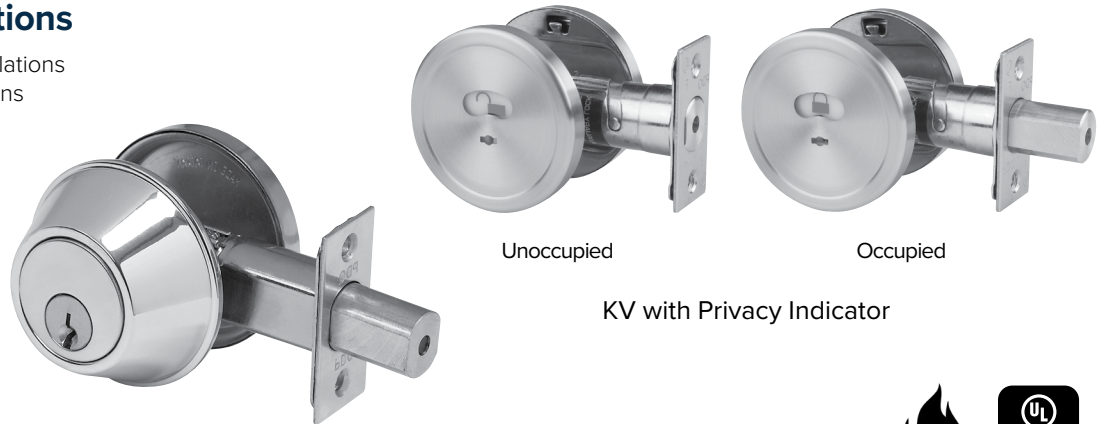

Unoccupied

Occupied

KV with Privacy Indicator



Specifications

FOR DOORS:	• 1-3/8" to 1-3/4" thick for Conventional Cylinder, 1-1/2" to 2" for SFIC
DOOR PREP:	• 2-1/8" DIA
BACKSET:	• 2-3/4"/2-3/8" adjustable (Default)
FRONT:	• 2-1/4" x 1" with filler plate • Stainless Steel or Wrought Brass
STRIKE:	• 2-3/4" x 1" • Stainless Steel or Wrought Brass • Dust Box Included
DEADBOLT:	• 1" Throw • Brass Bolt containing one 1/4" case-hardened Steel Roll Pin
HAND:	• Non-handed
TRIM:	• Stainless Steel or Wrought Brass Scalp
KEYS:	• Two (2) per Lock
KEYWAYS:	• SCC standard (Schlage C Compatible) • Also available in keyways of other manufacturers
INTERCHANGEABLE CORE:	• 6 or 7-pin • Compatible with Best, Falcon and Arrow
CYLINDER:	• 6-pin Brass Insert Cylinder keyed to 5-pins • Standard High Security and UL437 Cylinders Available
KEYING:	• Options: MK, CMK or GMK • Zero Bitted (KO), Keyed Different (KD) or Keyed Alike (KA) • Can be keyed into existing master key systems
FINISHES:	• 605 (US3), 606 (US4), 612 (US10), 613E, 622 (US19), 629 (US32), 630 (US32D)
CERTIFICATIONS, LISTINGS, COMPLIANCES:	• ANSI "Positive Pressure Fire Tests of Door Assemblies" for up to and including 3 hrs. • Complies with ADA (Americans with Disabilities Act) and ICC/ANSI 117.1 for Accessible and Usable Building • UL 10C listed, 3-hour fire rated as auxiliary locks for A label single doors • UL 10B listed for neutral pressure doors • TAA compliant. Country of origin: KR
WARRANTY:	• One (1) year Limited Warranty

PDQ Functions

FUNCTION	FUNCTION NUMBER	OUTSIDE INSIDE	DESCRIPTION	ANSI NUMBER
Single Cylinder	116		<ul style="list-style-type: none"> Lock or unlock by key from outside, by thumb turn from inside 	E2152
Single Sided	125		<ul style="list-style-type: none"> Deadbolt by inside thumb turn only Special door preparation required Surface mounted, 1-3/4" bore hole, one side 	E2192
Single Sided	125 BK		<ul style="list-style-type: none"> Deadbolt by inside thumb turn only 2-1/8" bore hole, one side 	E21112
Single Sided Indicator Deadbolt	125 IND		<ul style="list-style-type: none"> No key outside Indicator outside Thumbturn inside extends/retracts deadbolt Emergency key outside retracts deadbolt 	—
Double Cylinder	137		<ul style="list-style-type: none"> Lock or unlock by key from both sides 	E2142

How to Order

QUANTITY	SERIES	FUNCTION	FINISH	BACKSET	CYLINDER	KEYWAY	KEYING	OPTION
20	KV	116	630	ADJ	D	SCC	KD	—
NOTE: Case quantity is 20 / Case weight is 26 lbs. Single Cylinder / Case weight is 35 lbs. Double Cylinder			605 606 613E 622 626 630	ADJ — 2-1/4" x 1" (Default) ADJR — 2-1/4" x 1" x 1/4" Radius	D Default L Less Cylinder SF6 Lock is SFIC prepped w/ 6 pin core SF7 Lock is SFIC prepped w/ 7 pin core SFL Lock is SFIC prepped but less core SFC Lock is SFIC prepped w/ construction core SFP Lock is SFIC prepped w/ plastic construction core	PAGE 110		DB — Dust Box
				PAGE 110	PAGE 110			PAGE 110

Deadbolts

ANSI NO.	FUNCTION	DESCRIPTION	626/630	605/606/613E 622	CYLINDER OPTIONS	ICON	LOCK ADJUSTMENT
NON-CYLINDER - Thumbturn Inside							
E2192	125	Communicating	\$55.00	\$67.00	D		N/C
E21112	125BK	Communicating					
	125IND	Single Sided Indicator Deadbolt	\$77.00	\$89.00*			
SINGLE CYLINDER - Cylinder Outside / Thumbturn Inside							
E2152	116	Entrance	\$80.00	\$92.00	SFL		
DOUBLE CYLINDER							
E2142	137**	Store Door	\$102.00	\$114.00			

List prices shown include conventional key in knob/lever cylinder. For I-C, list prices do not include core.
 *125IND available in 626, 613E, 630 only **Not available in SFL

NOTES:

- Prices do not include IC Core
- 125 different prep
- 125BK different prep

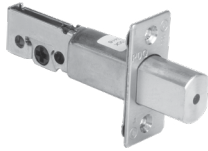

Backset

BACKSET DESCRIPTION	605	613E	622	630	LIST PRICE
<i>2-3/4" - 2-3/8" ADJUSTABLE</i>					
2-1/4" x 1-1/8" (Default)	I04507-5	I04507-6	I04507-H	I04507-1	\$50.00
2-1/4" x 1-1/8" x 1/4" Radius	I04507-5R	I04507-6R	I04507-H	I04507-1R	
1-1/8" Latch Front Filler Plate (Minimum of 100 pieces)	I099-100				\$5.00

KV SERIES
DEADBOLT LOCKS

Options

DESCRIPTION	605	613E	622	630	LIST PRICE
Deadbolt Strike (any finish) 2-3/4" x 1-1/8"	I4702-5	I4702-6	I4702-H	I4702-1	\$25.00
Dust Box	I4701				\$8.00

Miscellaneous Parts

DESCRIPTION	PDQ NO.	LIST PRICE
Emergency Release Key for KV125IND Deadbolt	I4711-EKEY	\$5.00



ASSEMBLED
IN THE USA

Typical Applications

- Auxiliary Doors
- Closets
- Commercial/Institutional/Military
- Common Areas
- Equipment Rooms
- Storerooms
- Restrooms
- Privacy Rooms



Specifications

Small Mortise Body Type Prep



FOR DOORS:	• 1-3/4"
BACKSET:	• 2-3/4"
CASE:	• Steel — Dichromated for corrosion resistance
FACEPLATE:	• 1-1/4" x 5-5/8"
STRIKE:	• 2-1/4" x 1" • Stainless Steel.
DEADBOLT:	• 1" Throw. • Stainless Steel.
THUMBTURN OPTION:	• ADA Compliant.
INDICATOR:	• Vacant/Occupied available.
HAND:	• Non-handed except for function MJ134 Classroom. (See Function Table and How to Order Guide).
KEYS:	• Two (2) per Lock.
KEYWAYS:	• SCC standard (Schlage C Compatible) • Also available in keyways of other manufacturers
INTERCHANGEABLE CORE:	• 6 or 7-pin • Compatible with Best, Falcon & Arrow • Large Format IC Cores compatible with Schlage.
CYLINDER:	• 6 or 7-pin Mortise Cylinder
KEYING:	• Options: MK, CMK or GMK • Zero Bitted (KO), Keyed Different (KD) or Keyed Alike (KA) • Can be keyed into existing master key systems
FINISHES:	• 605 (US3), 606 (US4), 612 (US10), 613E, 622 (US19), 629 (US32), 630 (US32D)
CERTIFICATIONS, LISTINGS, COMPLIANCES:	• UL listed for 3 hours, for single doors up to 4'0"x 8'0" • TAA compliant. Country of origin: Taiwan
WARRANTY:	• 10-Year Limited Warranty

Cross Reference*

ANSI # A156.5 (A156.13)	PDQ FUNCTION	BEST	CORBIN	DORMA	MARKS #31/32/33 SERIES	SARGENT	SCHLAGE	YALE
E06081 (F18)	MJ131	48H L	DL4111	D961	L	4876	L464	353
E06071 (F17)	MJ132	48H K	DL4113	D960	K	4875	L460	352
E06061 (F16)	MJ133	48H M	DL4112	D962	M	4874	L462	351
E06091 (F29)	MJ134LH	48H R	DL4117	D963	S	4877	L463	357
	MJ134LH							

*Note: Functions are equal, but form may differ.

How to Order

SERIES	FUNCTION	FINISH	CYLINDER	KEYWAY OR HOUSING	KEYING	OPTIONS
MJ	131	630	D	SCC	KD	—
		605 606 612 613E 622 629 630	D Default L Less Cylinder SF6 Lock is SFIC prepped w/ 6 pin core SF7 Lock is SFIC prepped w/ 7 pin core SFL Lock is SFIC prepped but less core SFC Lock is SFIC prepped w/ construction core SFP Lock is SFIC prepped w/ plastic construction core LF6 Lock is Schlage LFIC prepped w/ Schlage core LFL Lock is Schlage LFIC prepped but less core LFC Lock is Schlage LFIC prepped w/ construction core			ADA — Disability Thumbturn (ADA) AM — Antimicrobial Coating

Mortise Deadbolt

FUNCTION	FUNCTION NUMBER	OUTSIDE INSIDE	DESCRIPTION	630	605/606/613E/629 630/612/622
Single Cylinder	131		<ul style="list-style-type: none"> Key outside extends/retracts deadbolt 	\$272.00	\$284.00
Single Cylinder with Thumbturn	132		<ul style="list-style-type: none"> Key outside extends/retracts deadbolt Thumbturn inside extends/retracts deadbolt 	\$343.00	\$355.00
Double Cylinder	133		<ul style="list-style-type: none"> Key outside extends/retracts deadbolt Key inside extends/retracts deadbolt 	\$399.00	\$411.00
Single Cylinder (Classroom) Left Hand	134LH		<ul style="list-style-type: none"> Key outside extends/retracts deadbolt Inside cylinder turn retracts but does not extend deadbolt Thumbturn rotates clockwise 	\$373.00	\$385.00
Single Cylinder (Classroom) Right Hand	134RH		<ul style="list-style-type: none"> Key outside extends/retracts deadbolt Inside cylinder turn retracts but does not extend deadbolt Thumbturn rotates counter-clockwise 		
Single Cylinder w/Indicator (Privacy)	232		<ul style="list-style-type: none"> Key outside extends/retracts deadbolt Thumb turn inside extends/retracts deadbolt Indicator outside displays: <ul style="list-style-type: none"> Occupied when deadbolt is projected Vacant when deadbolt is retracted Indicator, outside — (VACANT/OCCUPIED) 	\$452.00	\$464.00

Note: For replacement T-Turn mortise cylinders for functions MJ134 RH and MJ134 LH, see the Cylinders and Keying Section.

Options

CODE	DESCRIPTION	LIST PRICE
ADA	Disability Thumbturn (ADA)	\$21.00
AM	Antimicrobial Coating (Not available with 605 finish)	\$37.00



ADA Thumbturn



PL-1 IC PADLOCK

Solid brass padlock with hardened steel shackle, accepts standard 6 or 7 pin SFIC lock cylinders (sold separately).

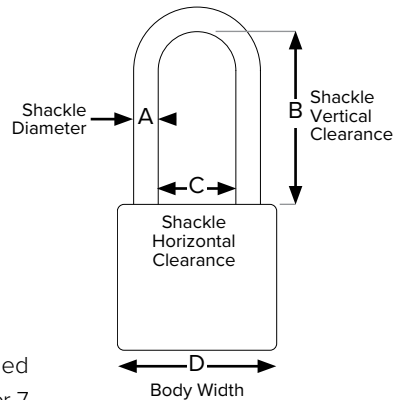

SHACKLE DIMENSIONS

Typical Applications

- Gates
- Higher Education
- Industrial
- K-12 Education

Shackle Size

A DIAMETER	B VERTICAL CLEARANCE	C HORIZONTAL CLEARANCE	D BODY WIDTH
5/16"	1-1/8"	25/32"	1-3/4"

How to Order

QUANTITY	SERIES	FUNCTION	KEYWAY	KEYING	OPTION
10	PL	1	PDQ1	KD	—
					CC — Chain & Clevis

NOTE: Case quantity is 10 / Case weight varies

Padlocks

FUNCTION	DESCRIPTION	SHACKLE	PDQ NO.	LIST PRICE
1	PL-1 IC Padlock	1-3/4" x 1-1/8"	I8512-7	\$42.00

NOTES:
• Prices do not include IC Core

Options

CODE	DESCRIPTION	PDQ NO.	LIST PRICE
CC	Chain & Clevis	I8512	\$12.00

Cores

DESCRIPTION	PDQ NO.	ADD
SMALL FORMAT UNCOMBINATED		
6 Pin Cores	I5206 + KEYWAY (I5206-A)	\$40.00
7 Pin Cores	I5207 + KEYWAY (I5207-B)	
COMBINATED		
6 Pin Cores	I5206-1 + KEYWAY (I5206-1A)	\$60.00
7 Pin Cores	I5207-1 + KEYWAY (I5207-1B)	
A (DEFAULT), B, C, D, E, F, G, H, J, K, L, M, Q, WA, WB, WC, WG, WH, TB, TD, TE, & R		
CONSTRUCTION CORES		
Construction Core 6-pin only		\$60.00
Dummy Construction Core Plastic Construction cores are invoiced at shipment and credited upon return. Subject to 50% discount.		\$8.00
VISUAL KEY CONTROL		LIST PRICE
Cylinder Marking AA1, AA2, Etc. (Per Cylinder)		\$10.00
Key Marking AA1, AA2, Etc. (Per Key)		
Key Marking other than Keyset (Per Key)		

NOTES:

- IC Cores are available
Combinated or Uncombinated
- Uncombinated cores do not include springs & pins
- Combinated cores includes master keying
- Designate finish for IC Cores ordered separately: 606 or 626

Features

- PDQ EPIC Series cylinders include a special format interchangeable core to retrofit into standard European Profile applications.
- Solid brass construction
- Can be incorporated into existing master key system
- Large thumbturn for ease of use
- EPIC Cores receive special machining to interface with housing. Specify (EP) designator for these cores (example: I5206EP-A)



EPIC SERIES

PDQ NO.	DESCRIPTION	LIST PRICE
I5131	EPIC, Single Cylinder 45MM	\$222.00
I5131L	EPIC, Single Cylinder 55MM	\$245.00
I5132	EPIC, Single Cylinder X Turn 45MM/40MM	\$260.00
I5132LIS	EPIC, Single Cylinder X Turn 45MM/55MM	\$282.00
I5132LOS	EPIC, Single Cylinder X Turn 55MM/45MM	
I5133	EPIC, Double Cylinder 45MM/45MM	\$260.00
I5133L	EPIC, Double Cylinder 55MM/45MM	\$292.00

Cores

DESCRIPTION	PDQ NO.	ADD
SMALL FORMAT UNCOMBINATED		
6 Pin Cores	I5206 + KEYWAY (I5206EP-A)	\$150.00
7 Pin Cores	I5207 + KEYWAY (I5207EP-B)	
COMBINATED		
6 Pin Cores	I5206-1 + KEYWAY (I5206EP-1A)	\$180.00
7 Pin Cores	I5207-1 + KEYWAY (I5207EP-1B)	
A (DEFAULT), B, C, D, E, F, G, H, J, K, L, M, Q, WA, WB, WC, WG, WH, TB, TD, TE, & R		
CONSTRUCTION CORES		
Construction Core 6-pin only		\$150.00
Dummy Construction Core Plastic Construction cores are invoiced at shipment and credited upon return. Subject to 50% discount.		\$6.00
VISUAL KEY CONTROL		LIST PRICE
Cylinder Marking AA1, AA2, Etc. (Per Cylinder)		\$10.00
Key Marking AA1, AA2, Etc. (Per Key)		
Key Marking other than Keyset (Per Key)		

NOTES:

- IC Cores are available Combined or Uncombined
- Uncombined cores do not include springs & pins
- Combined cores includes master keying
- Designate finish for IC Cores ordered separately: 606 or 626

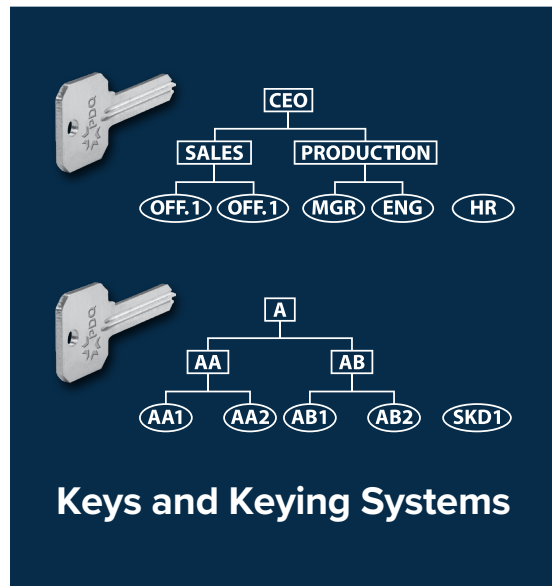

HIGH SECURITY

LIST PRICE

Effective July 3, 2023

Standard High Security Cylinders

DESCRIPTION	PDQ NO.	626	605	613E
6 Pin Key in Knob/Lever Cylinder KD/KA	HSC125	\$86.00	\$106.00	—
Mortise/Rim Combo Cylinder 1-1/8" 6 Pin KD/KA	HSC020	\$118.00	\$138.00	
Mortise Cylinder 1 1/4" 6 Pin KD/KA	HSC030			
Mortise Cylinder 1 1/2" 6 Pin KD/KA	HSC050	\$150.00	—	

Includes 2 Cut Keys. NOTE: Requires master keying, see below for charge.

NOTES:

- Prices for LFIC Mortise & Rim Cylinder Housings do not include IC Core
- Specify finish when ordering IC Housing & Cores
- High Security Cylinders not available "0" bitted.
- Key blanks for High Security Cylinders not available.

UL437 High Security Cylinders

DESCRIPTION	PDQ NO.	626	605	613E
UL 437 6 Pin Key in Knob/Lever Cylinder KD/KA	HSC425	\$105.00	\$139.00	—
UL 437 Mortise Rim Combo Cylinder 1-1/8" KD/KA	HSC320	\$140.00	\$174.00	
UL 437 Mortise Cylinder 1-1/4" KD/KA	HSC330			

Includes 2 Cut Keys. NOTE: Requires master keying, see below for charge.

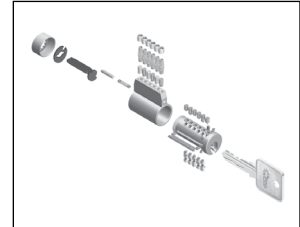

High Security Cylinder

High Security Keying Systems

DESCRIPTION	PDQ NO.	LIST PRICE
Cut Key, 6 pin	HSC065	\$15.00
SFIC Cut Key, IC 7 pin	HSC874	
LFIC Control Cut Key, IC 6 pin, TA	HSC965	
Master Keying Charge		\$24.00
Key Marking Charge		\$6.00
Cylinder Marking Charge		\$12.00

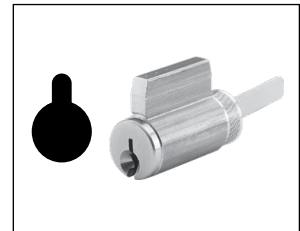

Key in Knob/Lever Cylinder

High Security Cores

DESCRIPTION	PDQ NO.	626
SFIC Cylinder, 6 Pin	HSC806	\$118.00
SFIC Cylinder, 7 Pin	HSC807	\$128.00
LFIC Cylinder Schlage® compatible, 6 Pin	HSC906	\$172.00

Includes Keying Charges and 2 Cut Keys

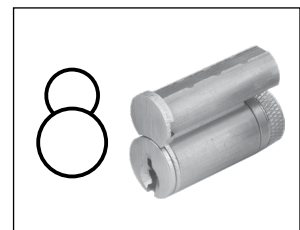
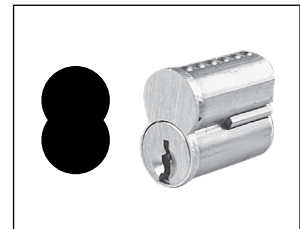

High Security Cams

DESCRIPTION	PDQ NO.	LIST PRICE
Adams Rite Type Cam	HSCCAM1	\$9.00
Yale Type Cam	HSCCAM2	
Yale Narrow Type Cam	HSCCAM2A	
Russwin Type Cam	HSCCAM3	
Falcon Type Cam	HSCCAM4	
Schlage Type Cam	HSCCAM7	
Sargent Offset Type Cam	HSCCAM8	
PDQ Cam	HSCCAM3	



UL 437 and High Security Cylinders

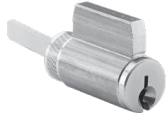

Conventional

Conventional Cylinders

PDQ's high quality conventional cylinders provide the standard level of security and functionality.

Interchangeable Core (IC) cylinders

Interchangeable core (IC) offers maximum flexibility to the building owner. Whenever a key is lost or stolen, locks can be rekeyed quickly by non-locksmith personnel. All it takes is the special "control" key. This key is used to remove and install all cores in the system. Just go to the door, remove the old core and install the new one with the control key. Security is regained in seconds! Unlike most other brands, PDQ interchangeable cores can always be integrated into existing systems with no adverse effect on the key system. IC cylinders are available in two sizes:



SFIC

Small Format Interchangeable Core (SFIC)

Based on a plug diameter smaller than the standard 1/2", SFIC cores are interchangeable with other SFIC installations.



LFIC

Large Format Interchangeable Core (LFIC)

Based on the industry standard plug diameter of 1/2", PDQ large format interchangeable cores (LFIC) are available for a variety of different key system types from standard and basic, to restricted and high security.



High security
key in knob cylinder

Standard High Security Cylinders

Conventional Key in Knob

Interchangeable Core - SFIC and LFIC

PDQ High Security cylinders are available in a number of formats, including the standard, KIK (Key In Knob or lever) cylinder used in most PDQ cylindrical locks, as well as a unique Mortise/Rim Cylinder that can be used in either configuration. All standard High Security cylinders feature 2 hardened anti-drill pins as well as our unique and proprietary PDQ keyway with sidebar.



High security
SFIC and LFIC cores
(SFIC shown)



UL 437
High Security Cylinders

UL 437 High Security Cylinders 437

For additional security, PDQ offers select cylinders in a UL437 package. These optional cylinders feature a minimum of 11 anti-drill, stainless steel pins and UL437 certification. UL437 available in all mortise, mortise rim and KIK keyed functions.

Conventional Key in Knob/Lever Cylinders



KEYWAY	CODE	606	626	LIST PRICE
PDQ TA (Restricted)	TA	V90504-844	V90504-744	\$78.00
Arrow AR1	AR1	V90504-830	V90504-730	
Corbin 59A1	CO59A1	V90504-829	V90504-729	
Corbin 60	CO6	V90504-819	V90504-719	
Corbin L4	CL4	V90504-822	V90504-722	
Falcon E-R	FAL	V90504-833	V90504-733	
Kwikset	KW	V90504-850	V90504-750	
Russwin 981	RUD981	V90504-821	V90504-721	
Russwin D1	RUD	V90504-820	V90504-720	
Sargent LA	SAL	V90504-805	V90504-705	
Sargent RA-RC	RA-RC	V90504-806	V90504-706	
Schlage C (Default)	SCC (Default)	V4802-8	V4802-7	
Schlage C-K	SCC-K	V90504-818	V90504-718	
Schlage E	SCE	V90504-817	V90504-717	
Yale E1R	YA8	V90504-831	V90504-731	
Yale GA	GA	V90504-835	V90504-735	

NOTES:

- Specify finish for cylinders
- Specify KD, KA4, or 1 bitted
- 6 pin cylinder keyed for 5 pin
- Specify lock series.
Example: GT, SD, etc.

CYLINDERS

LIST PRICE

Effective July 3, 2023

Rim Cylinders



KEYWAY	CODE	605	606	612	613E	625	626	LIST PRICE
PDQ TA (Restricted)	TA	I01705-6044	I01708-6044	I01703-6044	I01706-6044	I01702-6044	I01707-6044	\$84.00
Arrow AR1	AR1	I01705-6030	I01708-6030	I01703-6030	I01706-6030	I01702-6030	I01707-6030	
Corbin 59A1	CO59A1	I01705-6029	I01708-6029	I01703-6029	I01706-6029	I01702-6029	I01707-6029	
Corbin 60	CO6	I01705-6019	I01708-6019	I01703-6019	I01706-6019	I01702-6019	I01707-6019	
Corbin L4	CL4	I01705-6022	I01708-6022	I01703-6022	I01706-6022	I01702-6022	I01707-6022	
Falcon E-R	FAL	I01705-6033	I01708-6033	I01703-6033	I01706-6033	I01702-6033	I01707-6033	
Kwikset	KW	I01705-6050	I01708-6050	I01703-6050	I01706-6050	I01702-6050	I01707-6050	
Russwin 981	RUD981	I01705-6021	I01708-6021	I01703-6021	I01706-6021	I01702-6021	I01707-6021	
Russwin D1	RUD	I01705-6020	I01708-6020	I01703-6020	I01706-6020	I01702-6020	I01707-6020	
Sargent LA	SAL	I01705-605	I01708-605	I01703-605	I01706-605	I01702-605	I01707-605	
Sargent RA-RC	RA-RC	I01705-606	I01708-606	I01703-606	I01706-606	I01702-606	I01707-606	
Schlage C (Default)	SCC (Default)	I01705-6016	I01708-6016	I01703-6016	I01706-6016	I01702-6016	I01707-6016	
Schlage C-K	SCC-K	I01705-6018	I01708-6018	I01703-6018	I01706-6018	I01702-6018	I01707-6018	
Schlage E	SCE	I01705-6017	I01708-6017	I01703-6017	I01706-6017	I01702-6017	I01707-6017	
Yale E1R	YA8	I01705-6031	I01708-6031	I01703-6031	I01706-6031	I01702-6031	I01707-6031	
Yale GA	GA	I01705-6035	I01708-6035	I01703-6035	I01706-6035	I01702-6035	I01707-6035	
-----	Dummy	I01705-60D	I01708-60D	I01703-60D	I01706-60D	I01702-60D	I01707-60D	

CYLINDERS

LIST PRICE

Effective July 3, 2023

Mortise Cylinders



LENGTH INCLUDES CAM

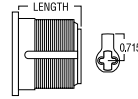

KEYWAY	PDQ KEYWAY	CYLINDER LENGTH	605	606	612	613E	625	626	630	LIST PRICE
Arrow AR1	AR1	15/16"	I01605-7030	I01608-7030	I01603-7030	I01606-7030	I01602-7030	I01601-7030	—	\$102.00
		1-1/8"	I01605-7130	I01608-7130	I01603-7130	I01606-7130	I01602-7130	I01601-7130	—	
		1-1/4"	I01605-7230	I01608-7230	I01603-7230	I01606-7230	I01602-7230	I01601-7230	—	
Corbin 59A1	C59A1	15/16"	I01605-7029	I01608-7029	I01603-7029	I01606-7029	I01602-7029	I01601-7029	—	
		1-1/8"	I01605-7129	I01608-7129	I01603-7129	I01606-7129	I01602-7129	I01601-7129	—	
		1-1/4"	I01605-7229	I01608-7229	I01603-7229	I01606-7229	I01602-7229	I01601-7229	—	
Corbin 60	CO6	15/16"	I01605-7019	I01608-7019	I01603-7019	I01606-7019	I01602-7019	I01601-7019	—	
		1-1/8"	I01605-7119	I01608-7119	I01603-7119	I01606-7119	I01602-7119	I01601-7119	—	
		1-1/4"	I01605-7219	I01608-7219	I01603-7219	I01606-7219	I01602-7219	I01601-7219	—	
Corbin L4	CL4	15/16"	I01605-7022	I01608-7022	I01603-7022	I01606-7022	I01602-7022	I01601-7022	—	
		1-1/8"	I01605-7122	I01608-7122	I01603-7122	I01606-7122	I01602-7122	I01601-7122	—	
		1-1/4"	I01605-7222	I01608-7222	I01603-7222	I01606-7222	I01602-7222	I01601-7222	—	
Russwin D1	RUD	15/16"	I01605-7020	I01608-7020	I01603-7020	I01606-7020	I01602-7020	I01601-7020	—	
		1-1/8"	I01605-7120	I01608-7120	I01603-7120	I01606-7120	I01602-7120	I01601-7120	—	
		1-1/4"	I01605-7220	I01608-7220	I01603-7220	I01606-7220	I01602-7220	I01601-7220	—	
Russwin 981	RUD981	15/16"	I01605-7021	I01608-7021	I01603-7021	I01606-7021	I01602-7021	I01601-7021	—	
		1-1/8"	I01605-7121	I01608-7121	I01603-7121	I01606-7121	I01602-7121	I01601-7121	—	
		1-1/4"	I01605-7221	I01608-7221	I01603-7221	I01606-7221	I01602-7221	I01601-7221	—	
Schlage E	SCE	15/16"	I01605-7017	I01608-7017	I01603-7017	I01606-7017	I01602-7017	I01601-7017	—	
		1-1/8"	I01605-7117	I01608-7117	I01603-7117	I01606-7117	I01602-7117	I01601-7117	—	
		1-1/4"	I01605-7217	I01608-7217	I01603-7217	I01606-7217	I01602-7217	I01601-7217	—	
Schlage C	SCC	15/16"	I01605-7016	I01608-7016	I01603-7016	I01606-7016	I01602-7016	I01601-7016	—	
		1-1/8"	I01605-7116	I01608-7116	I01603-7116	I01606-7116	I01602-7116	I01601-7116	—	
		1-1/4"	I01605-7216	I01608-7216	I01603-7216	I01606-7216	I01602-7216	I01601-7216	—	
		1-1/2"	I01605-7316	I01608-7316	I01603-7316	I01606-7316	I01602-7316	I01601-7316	—	
Schlage C-K	SCC-K	15/16"	I01605-7018	I01608-7018	I01603-7018	I01606-7018	I01602-7018	I01601-7018	—	
		1-1/8"	I01605-7118	I01608-7118	I01603-7118	I01606-7118	I01602-7118	I01601-7118	—	
		1-1/4"	—	I01608-7218	I01603-7218	I01606-7218	I01602-7218	I01601-7218	—	
Sargent LA	SAL	15/16"	I01605-705	I01608-705	I01603-705	I01606-705	I01602-705	I01601-705	—	
		1-1/8"	I01605-715	I01608-715	I01603-715	I01606-715	I01602-715	I01601-715	—	
		1-1/4"	I01605-725	I01608-725	I01603-725	I01606-725	I01602-725	I01601-725	—	
Sargent RA-RC	RA-RC	15/16"	I01605-706	I01608-706	I01603-706	I01606-706	I01602-706	I01601-706	—	
		1-1/8"	I01605-716	I01608-716	I01603-716	I01606-716	I01602-716	I01601-716	—	
		1-1/4"	I01605-726	I01608-726	I01603-726	I01606-726	I01602-726	I01601-726	—	
Yale E1R	YA8	15/16"	I01605-7031	I01608-7031	I01603-7031	I01606-7031	I01602-7031	I01601-7031	—	
		1-1/8"	I01605-7131	I01608-7131	I01603-7131	I01606-7131	I01602-7131	I01601-7131	—	
		1-1/4"	I01605-7231	I01608-7231	I01603-7231	I01606-7231	I01602-7231	I01601-7231	—	
Yale GA	GA	15/16"	I01605-7035	I01608-7035	I01603-7035	I01606-7035	I01602-7035	I01601-7035	—	
		1-1/8"	I01605-7135	I01608-7135	I01603-7135	I01606-7135	I01602-7135	I01601-7135	—	
		1-1/4"	I01605-7235	I01608-7235	I01603-7235	I01606-7235	I01602-7235	I01601-7235	—	
Falcon E-R	FAL	15/16"	I01605-7033	I01608-7033	I01603-7033	I01606-7033	I01602-7033	I01601-7033	—	
		1-1/8"	I01605-7133	I01608-7133	I01603-7133	I01606-7133	I01602-7133	I01601-7133	—	
		1-1/4"	I01605-7233	I01608-7233	I01603-7233	I01606-7233	I01602-7233	I01601-7233	—	
Kwikset	KW	15/16"	I01605-7050	I01608-7050	I01603-7050	I01606-7050	I01602-7050	I01601-7050	—	
		1-1/8"	I01605-7150	I01608-7150	I01603-7151	I01606-7150	I01602-7150	I01601-7150	—	
		1-1/4"	I01605-7250	I01608-7250	I01603-7250	I01606-7250	I01602-7250	I01601-7250	—	
PDQ TA (Restricted. Limited to Grand-master systems w/4 masters)	TA	15/16"	I01605-7044	I01608-7044	I01603-7044	I01606-7044	I01602-7044	I01601-7044	—	
		1-1/8"	I01605-7144	I01608-7144	I01603-7144	I01606-7144	I01602-7144	I01601-7144	—	
		1-1/4"	I01605-7244	I01608-7244	I01603-7244	I01606-7244	I01602-7244	I01601-7244	—	
		1-1/2"	I01605-7344	I01608-7344	I01603-7344	I01606-7344	I01602-7344	I01601-7344	—	
—	Dummy	1"	I01605-70D	I01608-70D	I01603-70D	I01606-70D	I01602-70D	I01601-70D	—	
		1-1/8"	I01605-71D	I01608-71D	I01603-71D	I01606-71D	I01602-71D	I01601-71D	—	
		1-1/4"	I01605-72D	I01608-72D	I01603-72D	I01606-72D	I01602-72D	I01601-72D	—	
—	T-Turn	15/16"	—	—	—	—	—	—	—	
		1-1/8"	I12605	I12608	I12603	I12606	I12602	I12607	—	
		1-1/4"	I22605	I22608	I22603	I22606	I22602	I22607	—	
—	T-Turn, Right Hand, Function MJ134 RH	1-1/4"	—	—	—	—	—	—	MJ522-01	
—	T-Turn, Left Hand, Function MJ134 LH	1-1/4"	—	—	—	—	—	—	MJ523-01	

INTERCHANGEABLE CORES

LIST PRICE
Effective July 3, 2023



Interchangeable Cores

CORE TYPE	KEYWAY	PDQ KEYWAY	ADD	PINS	606	626
Small Format (SFIC) BEST Compatible	UNCOMBINATED					
	Best A (Default), B, C, D, E, F, G, H, J, K, L, M, Q, R, WA, WB, WG, WH, TB, TD, TE, R	A (Default), B, C, D, E, F, G, H, J, K, L, M, Q, R, WA, WB, WG, WH, TB, TD, TE, R	\$40.00	6	I5206 - 8 - Specify Keyway	I5206 - 7 - Specify Keyway
				7	I5207 - 8 - Specify Keyway	I5207 - 7 - Specify Keyway
	COMBINATED					
	Best A (Default), B, C, D, E, F, G, H, J, K, L, M, Q, R, WA, WB, WG, WH, TB, TD, TE, R	A (Default), B, C, D, E, F, G, H, J, K, L, M, Q, R, WA, WB, WG, WH, TB, TD, TE, R	\$60.00	6	I5206 - 8-1- Specify Keyway	I5206 - 7-1- Specify Keyway
				7	I5207 - 8-1- Specify Keyway	I5207 - 7-1- Specify Keyway
	PDQ Exclusive	PDQ 1	\$60.00	6	I5206 - 8 - 41	I5206 - 7 - 41
		PDQ 2		7	I5207 - 8 - 41	I5207 - 7 - 41
	PDQ Exclusive and Restricted	PDQ 3	\$60.00	6	I5206 - 8 - 42	I5206 - 7 - 42
				7	I5207 - 8 - 42	I5207 - 7 - 42
Large Format (LFIC) Schlage Compatible	UNCOMBINATED					
	Schlage C (Default)	SCC (Default)	\$50.00	6	I5206-8-16	I5206-7-16
Large Format (LFIC) Schlage Compatible	COMBINATED					
	Schlage C (Default)	SCC (Default)	\$70.00	6	I5206-8-116	I5206-7-116
PDQ Restricted	TA	—		See High Security Section		
Construction Cores ¹	Small Format ² (BEST Compatible)	—	\$60.00	6 only	I5206	I5206
	Dummy, Plastic	—	\$8.00	—	I13520	I13520
	Large Format (Schlage Compatible)	—	\$70.00	—	I5206LFIC	I5206LFIC
	I-C Tailpiece and Spacer	—	\$10.00	—	VP92905	VP92905

Notes 1: No finish designation required. 2: Available in "L" keyway only.



Housings

DESCRIPTION	PDQ NO.	LIST PRICE
SFIC Mortise Cylinder Housing 6-pin 1-1/4", BEST [®] compatible	I5306-(specify finish)	\$75.00
SFIC Mortise Cylinder Housing 7-pin 1-3/8", BEST [®] compatible	I5307-(specify finish)	
SFIC Mortise Cylinder Housing (for both 6-pin/7-pin cores), 1-1/2", BEST [®] compatible	I5317-(specify finish)	
SFIC Mortise Cylinder Tapered 6-pin 1/2", BEST [®] compatible	I53013-067 (specify US3 or 26D)	
SFIC Mortise Cylinder Tapered 7-pin 1/2", BEST [®] compatible	I53013-077 (specify US10B or 26D)	
SFIC Rim Cylinder Housing (for both 6-pin/7-pin cores)	I5308-(specify finish)	\$90.00
LFIC Mortise Housing, Schlage [®] compatible	I5304-(specify finish)	
LFIC Rim Housing, Schlage [®] compatible	I5303-(specify finish)	

Cams

CAM LAYOUT	DESCRIPTION	WHERE USED	CONVENTIONAL MORTISE CYLINDER	SMALL FORMAT HOUSING	LARGE FORMAT HOUSING	LIST PRICE
	Adams Rite AR Cam	KT Series Deadbolts	1127-4205	154011	154211	\$9.00
	PDQ MR Cam	MR Series Mortise Locks	1127-4201	154061	154261	
	Straight Cam	6 EW Series Wide Stile Escutcheon Exit Device Trim	1127-4202	154031	154231	
	Schlage Cloverleaf Cam		1127-4209	154051	154221	
	Sargent Std Cam		1127-4204	154041	N/A	
	Lockwood		1127-4203	154021	N/A	

Keyways



Standard (Open) Keyways

Best suited for applications where fast and easy key duplication is required and low key control is required.



Exclusive Keyways (PDQ1, PDQ2)

PDQ offers two exclusive key systems that utilize key blanks that are very hard to find in the marketplace, thereby reducing the chances of unauthorized duplication.



Restricted Keyways (TA, PDQ3)

The PDQ restricted keyway is only available from PDQ and is shipped directly to the authorized end user. Restricted key systems are ideal when there is a significant need to eliminate an unauthorized duplication by lock shops, hardware and home centers. They provide a higher level of security, with authorization required for the order of key blanks for duplication. Each key is registered and no blank keys are sold. A letter of authorization on the end user's stationery must be submitted with the initial order to establish the authorized ship to location.

Key Blanks

Conventional



Large Bow

Ideal for special keys which must be visibly distinctive within a key system, or for very specialized marking.



Only available in Schlage C

Interchangeable Core



Construction Cores

Temporary construction cores are an excellent way to ensure the security of a construction site. Another more secure way to ensure the security of the construction site is the use of temporary cores. PDQ offers both standard and disposable construction cores for this purpose. The standard cores are painted black above the keyway identifying them as construction cores. These can be returned at job's end for a full credit. Disposable cores are not key lockable and are discarded when the job is complete.

Construction Master Keying (CMK):

PDQ offers the CMK keying option which provides extra security during the transition from the construction phase to completion. A construction master key operates all PDQ cylinders while the building is under construction. Upon completion of the construction phase, it can be voided without removing the cylinders from the locks simply by turning the change key in each cylinder.

KEYING SYSTEMS

LIST PRICE
Effective July 3, 2023

CODE	KEYING SYSTEMS	LIST PRICE
KD	Keyed Random	N/C
OB	0-Bitted with 2 blank keys (For quality control purposes, PDQ "0" bit cylinders are actually keyed to a 1 bit and a 1 bit key is sent to open cylinders.)	
KA2	Keyed Alike, 2 or less (KA2)	
KA4	Keyed Alike, 3-4 (KA3 or KA4)	\$14.00 each
KA	Keyed Alike, 5 or More (KA5)	
MK	Master Keyed	\$24.00 each
KE	Master Keyed to Existing Bittings:	
CMK	Construction Master Keyed	\$42.00 each
CODE	MASTER KEY SERVICES	
	Number of Bittings	
B100	1-100	\$125.00
B300	101-300	\$190.00
B1000	301-1000	\$275.00
B2000	1001- 2000	\$375.00
B5000	2001- 5000	\$475.00
	Master Key Service is a custom master key system that is provided with the purchase of complete PDQ manufactured locks and locking devices. A master key service charge will be assessed for any order that includes only PDQ cylinders or cores for use on non-PDQ locks or locking devices.	
BL	Bitting List for Factory Master Key Production	\$110.00
CODE	VISUAL KEY CONTROL	
VKC-KEY	Visual Key Control - Key Stamping	\$6.00
VKC-CYL	Visual Key Control - Cylinder Stamping	\$12.00
VKC-COR	Visual Key Control - Core Stamping	
CODE	KEY CUT CHARGE – MASTER/CONTROL/CHANGE	
MKC	Master Key	\$15.00
GMKC	Grand Master Key	
GGMKC	Grand Grand Master Key	
CMKC	Construction Master Key	
CTLK	Control Key	
CKC	Change Key	
CODE	EXTRA KEY CUTS	
IO 24 05-00	Extra Key Cuts	



Visual Key Control

LOCK AND KEY PARTS

LIST PRICE

Effective July 3, 2023

Key Blanks (50 Piece Minimum Order)

PDQ KEYWAY	COMPATIBLE WITH	LIST PRICE	
		5-PIN	6-PIN
ARA	Arrow / AR1	\$4.00	
CO59A1	Corbin 59A1		
CO6	Corbin / 60		
CL4	Corbin / L4		
RUD	Russwin / D1		
SCC	Schlage / C		
SCE	Schlage / E		
SAL	Sargent / LA		
SAS	Sargent / SAS		
RA-RC	Sargent / RA-RC		
YA8	Yale / E11		
GA	Yale / GA		
FAL	Falcon / E-R		
KW	Kwikset / KW		
TA	PDQ / TA (Restricted. Limited to Grandmaster systems w/4 sub masters)		
Large Bow Key	SCC		
Large Bow Key	SCE		
INTERCHANGEABLE CORE KEY BLANKS			PRICE EACH
Best Keyways: A, B, C, D, E, F, G, H, J, K, L, M, Q, WA, WB, WC, WD, WG, WH, TB, TD, TE, R, DD			\$5.00
IC Keyblank Stamped "U.S. Govt". Min order qty: 50ea			\$6.00

NOTES:

- Specify finish when ordering miscellaneous parts
- Kwikset cylinder available in 5 pin only



6 Pin Key Blank / 5 Pin Key Blank



Collars

IC Key blanks are stamped DND prohibiting duplication as standard. Unmarked blanks are available upon request.

Miscellaneous Parts

DESCRIPTION	PDQ NO.	LIST PRICE
1-1/4" x 4-7/8" ANSI Dust Box (Specified with Lock)	Y025-SBX	\$8.00
1-1/4" x 4-7/8" ANSI Dust Box	Y025-SBX	
T-Strike Dust Box (Specified with Lock)	I0251	
T-Strike Dust Box	I0251	
FL-Strike Dust Box (Specified with Lock)	I0251R	
FL-Strike Dust Box	I0251R	
1-1/8" x 2-3/4" Deadbolt Dust Box	I4701	
IC Tailpiece assembly includes tailpiece and spacer	VP92905	\$10.00
GP Screw pack (any finish) / GT Screw pack (any finish)	V91910 / VA10030	\$8.00
1-1/8" Latch Front Filler Plate (Minimum of 100 pieces)	I099-100	\$2.00
COLLARS AND BLOCKING RINGS		
Rim Cylinder Ring	I5502	\$4.00
Mortise Cylinder Ring Step 5/32"	I5501	
Blocking Ring 1/8"	I55121	
Blocking Ring 5/32"	I034	
Blocking Ring 1/4"	I55012	\$17.00
Vandal Collar 11/16"	I5504	
Vandal Collar 13/16"	I5503	

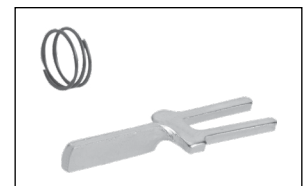

SFIC Tailpieces

*Works with both GP and GT, SX and SD latches. (Grade 1 latches requires removal of breakaway center)

Security. Performance. Flexibility.

Exit devices are a critical part of a building's fire and life safety egress system. PDQ manufactures a full line of exit devices, including rim, vertical rod and mortise for both wide and narrow stile doors. These devices provide the best combination of simplicity, strength, durability, aesthetics, and innovation and are perfect for a vast array of applications.

Comprehensive Offering

6300
Architectural Wide Stile



Applications

The all NEW 6300 Series Wide Stile Exit Devices incorporate modern push bar styling for heavy traffic applications. These Grade 1 certified devices are put to the ultimate test everyday in K-12, higher education, Healthcare, and government buildings. Other applications include offices, banks, assisted living facilities, retail stores, and other commercial buildings that have constant traffic.

6400
Architectural Narrow Stile



Applications

The all NEW 6400 Series Wide Stile Exit Devices incorporate modern push bar styling for heavy traffic applications. These Grade 1 certified devices are put to the ultimate test everyday in K-12, higher education, Healthcare, and government buildings. Other applications include offices, banks, assisted living facilities, retail stores, and other commercial buildings that have constant traffic.

4200
Commercial Wide Stile



Applications

When low cost and dependability are essential, the 4200 Series is a great choice. A reliable workhorse, the 4200 Series is an economical answer for stock doors and frames.

9300
Mullions

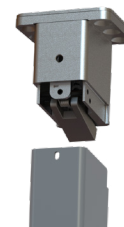

Applications

Designed for quick removal, the 9300 mullion is ideal in situations where carts, gurneys and large machinery need to pass freely through an opening. Popular applications include Healthcare, industrial manufacturing, and commercial businesses.



6300/6400 SERIES

Architectural Exit Device

Highlights

Chassis support is cast for high strength.

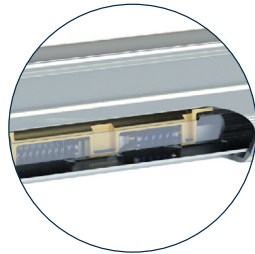
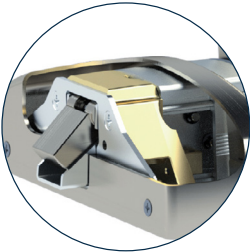

Push bar has angled ends and is nearly flush when dogged.

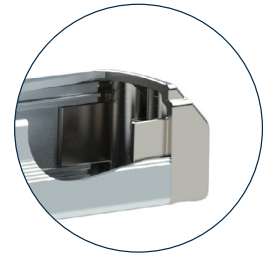
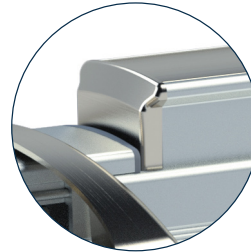

Flush end cap is standard, heavy duty engineered casting keys into the rail for ultimate pry resistance.

Cush spring quiets device in both directions. Compression spring returns the touch bar providing more reliability than a torsion type spring.

Features

- Rugged, reliable, flexible, and simple design
- Designed & Assembled in Lancaster, PA
- Patent Pending
- Quiet operation - large heavy-duty spring cushion quiets both the compression/extension of the push bar
- Internal compression spring ensures long lasting push bar return
- Engineered strong and overbuilt for the most demanding environments
- Durable, heavy-duty flush end cap is standard and resist prying
- Stands up to cart abuse, heavy-duty flush end cap and tapered push bar designed to deflect hits and minimize damage
- Simple field door prep and installation
- Dogging holds bar in a retracted position nearly flush with head cover and rail
- Hex Key provided to dog/release the device
- No exposed screws on back of bar
- True 2-3/4" backset (with 5/8" frame stop and 1/8" door gap)
- Wood and machine screws included with each device
- Devices and trim are non-handed
- Ten (10) year warranty



Rim
6300R / 6400R



Surface Vertical Rod
6300V / 6400V



Concealed Vertical Rod
6300C / 6400C



Mortise
6300M

6300/6400R SERIES

Wide/Narrow Stile Rim Exit Device



ASSEMBLED
IN THE USA

6300R Wide Stile/6400R Narrow Stile Panic & Fire Rated



Specifications



Rail	• Extruded aluminum
Latch	• Stainless steel dead locking with 3/4" throw
Hand	• Device is non-handed • Trim is non-handed or field reversible
Dogging	• Hex key dogging standard • Cylinder dogging optional • Dogging not available for fire labeled devices
Minimum Stile Width	• 6300 - 3-1/2" • 6400 - 3 1/8" with 639027/639057 strike and 2 1/8" on aluminum frames with blade stop strike.
Door Thickness	• 1-3/4" - 2" (Consult factory for other)
Door Width	• 24", 36", 48" standard
Door Height	• Panic - Up to 10' • Fire - See fire ratings charts page 146
Strike Options	• Roller (Default) • Blade stop • Double door • Windstorm/Fire Mullion - Panic Mullion uses standard roller strike
Finishes	• 605 - Polished Brass, 606 - Satin Brass, 613E - Dark Bronze, 622 - Flat Black, 626 - Satin Chrome, 630 - Satin Stainless Steel • Optional Anti Microbial Coating available on 626, 630
Fasteners	• Includes machine and wood screws • SNB Optional
Warranty	• Ten (10) year limited warranty
Electrified Options	• Motorized Latch Retraction • Request to Exit/Signal Switch • Alarmed Exit • Latch Bolt Monitor • ISMC Connectors
Certifications: Compliances: Listings:	• Listed for UL 305 "Panic", listed for UL 10C "Fire Exit Hardware" up to 3 hours. • Certified to ANSI/BHMA A156.3 Grade 1 • FL #40297 +60/-65 psf 4080 16ga Single • FL #40297 +50/-50 psf 4080 18ga Single • Complies with ADA (Americans with Disabilities Act) and ICC/ANSI 117.1 for Accessible and Usable Buildings • Meets requirements of the BAA as a COTS product manufactured in the United States

6300/6400 RIM EXIT DEVICE

LIST PRICE
Effective July 3, 2023

6300/6400
RIM EXIT DEVICE

How to Order

Series	For Door Width	Device Type	Rating	Finish	Options	Electrified Options
63	00	R	--	630	--	--
63 - Wide Stile Device 64 - Narrow Stile Device	00 - 36" Door 10 - 48" Door 20 - 24" Door	R - Rim Device	Blank - Panic Rated F - Fire Rated	605 – Bright Brass 606 – Satin Brass 613E – Dark Bronze 622 – Satin Black 625 – Bright Chrome 626 – Satin Chrome 630 – Satin Stainless	Dogging (Panic Rated Only): Blank - Hex Key Dogging CD - Cylinder Dogging LD - Less Dogging* Strikes: BS - Blade Stop Strike (Rim) DD - Double Door Strike (Rim) WS – Windstorm Rated (Rim & SVR) EC - End Cap Cover TLA - Head Cover SNB - Sex Nuts & Bolts AM - Anti-Microbial SK - Shim Kit SHS - Security Head Screws	MLR - Motorized Latch Retr. AL - Alarm Kit* SS - Signal Switch on touch bar LM - Latchbolt Monitor ISMC - Industry Standard Molex Connector ALHW - Alarm kit hard wired

*Multiple Selections Allowed
 *Dogging options only apply to Panic Rated
 *MLR can be combined with LM & SS
 *AL can be combined with LM
 *MLR and AL cannot be combined
 *ISMC available on all
 *AL - specify handing

6300R Rim Wide Stile Exit Devices

PART	DESCRIPTION	630	613E/622/626	605/606/625
6300R	Rim, Listed to UL305 for Panic, hex key dogging, 3'0" door	\$900.00	\$943.00	\$1035.00
6300RF	Rim, Listed to UL10C for Fire, no dogging 3'0" door	\$1062.00	\$1105.00	\$1197.00
6310R	Rim, Listed to UL305 for Panic, hex key dogging, 4'0" door	\$946.00	\$989.00	\$1081.00
6310RF	Rim, Listed to UL10C for Fire, no dogging 4'0" door	\$1108.00	\$1151.00	\$1243.00
6320R	Rim, Listed to UL305 for Panic, no dogging, 2'0" door	\$1000.00	\$1043.00	\$1135.00
6320RF	Rim, Listed to UL10C for Fire, no dogging 2'0" door	\$1162.00	\$1205.00	\$1297.00

Available with all electrified options.

6400R Rim Narrow Stile Exit Devices

PART	DESCRIPTION	630	613E/622/626	605/606/625
6400R	Rim, Listed to UL305 for Panic, hex key dogging, 3'0" door	\$983.00	\$1026.00	\$1118.00
6400RF	Rim, Listed to UL10C for Fire, no dogging 3'0" door	\$1145.00	\$1188.00	\$1280.00
6410R	Rim, Listed to UL305 for Panic, hex key dogging, 4'0" door	\$1029.00	\$1072.00	\$1164.00
6410RF	Rim, Listed to UL10C for Fire, no dogging 4'0" door	\$1191.00	\$1234.00	\$1326.00
6420R	Rim, Listed to UL305 for Panic, no dogging, 2'0" door	\$1083.00	\$1126.00	\$1218.00
6420RF	Rim, Listed to UL10C for Fire, no dogging 2'0" door	\$1245.00	\$1288.00	\$1380.00

6300/6400 RIM EXIT DEVICE

LIST PRICE

Effective July 3, 2023

6300/6400R Rim Mechanical Options

PART	DESCRIPTION	EXIT DEVICE ADJUSTMENT
EC	End Cap Cover	\$26.00
TLA	Head Cover (Similar to 6200 Series)	
AM	Anti Microbial (630/626 only)	\$98.00
WS	Florida HVHZ	\$66.00
CD	Cylinder Dogging	\$76.00
LD	Less Dogging	-
SNB	Sex Nuts & Bolts	\$26.00
BS	Blade Stop Strike	\$63.00
DD	Double Door Strike	
SHS	Tamper Proof Security Head Screws	\$54.00

6300/6400R Rim Electrified Options

PART	DESCRIPTION	LIST PRICE
AL	Alarmed Exit	\$415.00
LM	Latch Bolt Monitoring	\$286.00
MLR	Motorized Latch Retraction	\$1030.00
SS	Signal Switch - Request to Exit or touch bar Monitoring	\$215.00
ALHW	Alarmed Exit with Hard Wire Power and Relay	\$580.00
ISMC	Industry Standard Molex Connector (order in addition to other electrified options)	\$108.00

1: Electrified options not available on 24" device.

2: For the MLR Motorized Latch Retraction option: 3 ft devices, maximum cut is 3". 4 ft devices, maximum cut is 9".

3: For the Alarm option: 3 ft devices, maximum cut is 2". 4 ft devices, maximum cut is 8".

6300/6400V SERIES

Wide/Narrow Stile Surface Vertical Rod Exit Device



ASSEMBLED
IN THE USA

6300V Wide Stile/6400V Narrow Stile Panic & Fire Rated



Specifications

Rail	• Extruded aluminum
Latch	• Top - Stainless Steel 3/4" toggle • Bottom - 5/8" Travel Drop Bolt • Less bottom rod option
Hand	• Device is non-handed • Trim is non-handed or field reversible
Dogging	• Hex key dogging standard • Cylinder dogging optional • Dogging not available for fire labeled devices
Minimum Stile Width	• 6300 - 3-1/2" • 6400 - 3 1/8" with 639027/639057 strike and 2 1/8" on aluminum frames with balde stop strike.
Door Thickness	• 1-3/4" - 2" (Consult factory for other)
Door Width	• 24", 36", 48" standard
Door Height	• Panic - Up to 10' • Fire - See fire ratings charts page 146
Strike	• Cast top strike, plate bottom strike
Finishes	• 605 - Polished Brass, 606 - Satin Brass, 613E - Dark Bronze, 622 - Flat Black, 626 - Satin Chrome, 630 - Satin Stainless Steel • Optional Anti-Microbial Coating available on 626, 630
Fasteners	• Includes machine screws and wood screws • SNB Optional
Warranty	• Ten (10) year limited warranty
Electrified Options	• Motorized Latch Retraction • Request to Exit/Signal Switch • Alarmed Exit • Latch Bolt Monitor • ISMC Connectors
Certifications: Compliances: Listings:	• Listed for UL 305 "Panic", listed for UL 10C "Fire Exit Hardware" up to 3 hours. • ANSI/BHMA A156.3 Grade 1 • Complies with ADA (Americans with Disabilities Act) and ICC/ANSI 117.1 for Accessible and Usable Buildings • FL #40297 +50/-50 psf 8080 18ga Pair • Meets requirements of the BAA as a COTS product manufactured in the United States

6300/6400 SURFACE VERTICAL ROD EXIT DEVICE

LIST PRICE

Effective July 3, 2023

How to Order

6300/6400 SURFACE VERTICAL ROD EXIT DEVICE

Series	For Door Width	Device Type	Rating	Finish	Options	Electrified Options
63	00	V	--	630	--	--
63 - Wide Stile Device 64 - Narrow Stile Device	00 - 36" Door 10 - 48" Door 20 - 24" Door	V - SVR Device	Blank - Panic Rated F - Fire Rated	605 – Bright Brass 606 – Satin Brass 613E – Dark Bronze 622 – Satin Black 625 – Bright Chrome 626 – Satin Chrome 630 – Satin Stainless	Dogging (Panic Rated Only): Blank - Hex Key Dogging CD - Cylinder Dogging LD - Less Dogging* LBR - Less Bottom Rod (SVR/CVR) LBR-FP - Less Bottom Rod with Fire Pin (SVR/CVR) WS – Windstorm Rated (Rim & SVR) EC - End Cap Cover TLA - Head Cover SNB - Sex Nuts & Bolts AM - Anti-Microbial SK - Shim Kit SHS - Security Head Screws 7 - 7' door (default) 8 - 8' door 10 - 8'-10' Door	MLR - Motorized Latch Retr. AL - Alarm Kit* SS - Signal Switch on touch bar LM - Latchbolt Monitor ISMC - Industry Standard Molex Connector ALHW - Alarm kit hard wired

*Multiple Selections Allowed
 *Dogging options only apply to Panic Rated

6300V Surface Vertical Rod Wide Stile Exit Devices

PART	DESCRIPTION	630	613E/622/626	605/606/625
6300V	Surface vertical rod, Listed to UL305 for Panic, hex key dogging, 3'0" door			
6300VLBR	Surface vertical rod, less bottom rod, Listed to UL305 for Panic, hex key dogging, 3'0" door	\$1357.00	\$1400.00	\$1492.00
6300VF	Surface vertical rod, Listed to UL10C for Fire, no dogging, 3'0" door			
6300VFLBR*	Surface vertical rod, less bottom rod, Listed to UL10C for Fire, no dogging, 3'0" door	\$1519.00	\$1562.00	\$1654.00
6310V	Surface vertical rod, Listed to UL305 for Panic, hex key dogging, 4'0" door			
6310VLBR	Surface vertical rod, less bottom rod, Listed to UL305 for Panic, hex key dogging, 4'0" door	\$1403.00	\$1446.00	\$1538.00
6310VF	Surface vertical rod, Listed to UL10C for Fire, no dogging, 4'0" door			
6310VFLBR*	Surface vertical rod, less bottom rod, Listed to UL10C for Fire, no dogging, 4'0" door	\$1565.00	\$1608.00	\$1700.00
6320V	Surface vertical rod, Listed to UL305 for Panic, no dogging, 2'0" door			
6320VLBR	Surface vertical rod, less bottom rod, Listed to UL305 for Panic, no dogging, 2'0" door	\$1457.00	\$1500.00	\$1592.00
6320VF	Surface vertical rod, Listed to UL10C for Fire, no dogging, 2'0" door			
6320VFLBR*	Surface vertical rod, less bottom rod, Listed to UL10C for Fire, no dogging, 2'0" door	\$1619.00	\$1662.00	\$1754.00

For devices over 7' high, add \$25 per foot

*LBR FIRE RATED DEVICES MUST BE ORDERED IN PAIRS. One fire pin furnished per pair.

6400V Surface Vertical Rod Narrow Stile Exit Devices

PART	DESCRIPTION	630	613E/622/626	605/606/625
6400V	Surface vertical rod, Listed to UL305 for Panic, hex key dogging, 3'0" door	\$1439.00	\$1482.00	\$1574.00
6400VLBR	Surface vertical rod, less bottom rod, Listed to UL305 for Panic, hex key dogging, 3'0" door			
6400VF	Surface vertical rod, Listed to UL10C for Fire, no dogging, 3'0" door	\$1601.00	\$1644.00	\$1736.00
6400VFLBR*	Surface vertical rod, less bottom rod, Listed to UL10C for Fire, no dogging, 3'0" door			
6410V	Surface vertical rod, Listed to UL305 for Panic, hex key dogging, 4'0" door	\$1485.00	\$1528.00	\$1620.00
6410VLBR	Surface vertical rod, less bottom rod, Listed to UL305 for Panic, hex key dogging, 4'0" door			
6410VF	Surface vertical rod, Listed to UL10C for Fire, no dogging, 4'0" door	\$1647.00	\$1690.00	\$1782.00
6410VFLBR*	Surface vertical rod, less bottom rod, Listed to UL10C for Fire, no dogging, 4'0" door			
6420V	Surface vertical rod, Listed to UL305 for Panic, no dogging, 2'0" door	\$1539.00	\$1582.00	\$1674.00
6420VLBR	Surface vertical rod, less bottom rod, Listed to UL305 for Panic, no dogging, 2'0" door			
6420VF	Surface vertical rod, Listed to UL10C for Fire, no dogging, 2'0" door	\$1701.00	\$1744.00	\$1836.00
6420VFLBR*	Surface vertical rod, less bottom rod, Listed to UL10C for Fire, no dogging, 2'0" door			

For devices over 7' high, add \$25 per foot

***LBR FIRE RATED DEVICES MUST BE ORDERED IN PAIRS.** One fire pin furnished per pair.

6300/6400
 SURFACE VERTICAL ROD
 EXIT DEVICE

6300/6400 SURFACE VERTICAL ROD EXIT DEVICE

LIST PRICE

Effective July 3, 2023

6300/6400V Surface Vertical Rod Mechanical Options

PART	DESCRIPTION	EXIT DEVICE ADJUSTMENT
EC	End Cap Cover	\$26.00
TLA	Head Cover (Similar to 6200 Series)	
AM	Anti Microbial (630/626 only)	\$98.00
CD	Cylinder Dogging	\$76.00
LD	Less Dogging	-
SNB	Sex Nuts & Bolts	\$26.00
SHS	Tamper Proof Security Head Screws	\$54.00
LBR	Less Bottom Rod	-
LBR-FP	Less Bottom Rod with Fire Pin (used with fire rated pair)	-

6300/6400V Surface Vertical Rod Electrified Options

PART	DESCRIPTION	LIST PRICE
AL	Alarmed Exit	\$415.00
LM	Latch Bolt Monitoring	\$286.00
MLR	Motorized Latch Retraction	\$1030.00
SS	Signal Switch - Request to Exit and Monitoring	\$215.00
ALHW	Alarmed Exit with Hard Wire Power and Relay	\$580.00
ISMC	Industry Standard Molex Connector (order in addition to other electrified options)	\$108.00

1: Electrified options not available on 24" device.

2: For the MLR Motorized Latch Retraction option: 3 ft devices, maximum cut is 3". 4 ft devices, maximum cut is 9".

3: For the Alarm option: 3 ft devices, maximum cut is 2". 4 ft devices, maximum cut is 8".

6300/6400C SERIES

Wide/Narrow Stile Concealed Vertical Rod Exit Device



ASSEMBLED
IN THE USA

6300C Wide Stile/6400C Narrow Stile Panic & Fire Rated



Specifications

Rail	• Extruded aluminum
Latch	• Top - Stainless Steel 3/4" toggle • Bottom - 5/8" Travel Drop Bolt • Less bottom rod option
Hand	• Device is non-handed • Trim is non-handed or field reversible
Dogging	• Hex key dogging standard • Cylinder dogging optional • Dogging not available for fire labeled devices
Minimum Stile Width	• 6300 - 3-1/2" • 6400 - 3 1/8" with 639027/639057 strike and 2 1/8" on aluminum frames with balde stop strike.
Door Thickness	• 1-3/4" - 2" (Consult factory for other)
Door Width	• 24", 36", 48" standard
Door Height	• Panic - Up to 10' • Fire - See fire ratings charts page 146
Strike	• Cast top strike, plated bottom strike
Finishes	• 605 - Polished Brass, 606 - Satin Brass, 613E - Dark Bronze, 622 - Flat Black, 626 - Satin Chrome, 630 - Satin Stainless Steel • Optional Anti-Microbial Coating available on 626, 630
Fasteners	• Includes machine and wood screws • SNB Optional
Warranty	• Ten (10) year limited warranty
Electrified Options	• Motorized Latch Retraction • Request to Exit/Signal Switch • Alarmed Exit • Latch Bolt Monitor • ISMC Connectors
Certifications: Compliances: Listings:	• Listed for UL 305 "Panic", listed for UL 10C "Fire Exit Hardware" up to 3 hours. • ANSI/BHMA A156.3 Grade 1 Pending • Complies with ADA (Americans with Disabilities Act) and ICC/ANSI 117.1 for Accessible and Usable Buildings • Meets requirements of the BAA as a COTS product manufactured in the United States

6300/6400 CONCEALED VERTICAL ROD EXIT DEVICE LIST PRICE

Effective July 3, 2023

How to Order

Series	For Door Width	Device Type	Rating	Finish	Options	Electrified Options
63	00	C	--	630	--	--
63 - Wide Stile Device 64 - Narrow Stile Device	00 - 36" Door 10 - 48" Door 20 - 24" Door	C - CVR Device	Blank - Panic Rated F - Fire Rated	605 – Bright Brass 606 – Satin Brass 613E – Dark Bronze 622 – Satin Black 625 – Bright Chrome 626 – Satin Chrome 630 – Satin Stainless	Dogging (Panic Rated Only): Blank - Hex Key Dogging CD - Cylinder Dogging LD - Less Dogging* LBR - Less Bottom Rod (SVR/CVR) LBR-FP - Less Bottom Rod with Fire Pin (SVR/CVR) EC - End Cap Cover TLA - Head Cover SNB - Sex Nuts & Bolts AM - Anti-Microbial 7 - 7' door (default) 8 - 8' door 10 - 8'-10' Door	MLR - Motorized Latch Retr. AL - Alarm Kit* SS - Signal Switch on touch bar LM - Latchbolt Monitor ISM - Industry Standard Molex Connector

*Multiple Selections Allowed
 *Dogging options only apply to Panic Rated

6300C Concealed Vertical Rod Wide Stile Exit Devices

PART	DESCRIPTION	630	613E/622/626	605/606/625
6300C	Concealed vertical rod, Listed to UL305 for Panic, hex key dogging, 3'0" door	\$1570.00	\$1613.00	\$1705.00
6300CLBR	Concealed vertical rod, less bottom rod, Listed to UL305 for Panic, hex key dogging, 3'0" door			
6300CF	Concealed vertical rod, Listed to UL10C for Fire, no dogging, 3'0" door	\$1732.00	\$1775.00	\$1867.00
6300CFLBR*	Concealed vertical rod, less bottom rod, Listed to UL10C for Fire, no dogging, 3'0" door			
6310C	Concealed vertical rod, Listed to UL305 for Panic, hex key dogging, 4'0" door	\$1616.00	\$1659.00	\$1751.00
6310CLBR	Concealed vertical rod, less bottom rod, Listed to UL305 for Panic, hex key dogging, 4'0" door			
6310CF	Concealed vertical rod, Listed to UL10C for Fire, no dogging, 4'0" door	\$1778.00	\$1821.00	\$1913.00
6310CFLBR*	Concealed vertical rod, less bottom rod, Listed to UL10C for Fire, no dogging, 4'0" door			
6320C	Concealed vertical rod, Listed to UL305 for Panic, no dogging, 2'0" door	\$1670.00	\$1713.00	\$1805.00
6320CLBR	Concealed vertical rod, less bottom rod, Listed to UL305 for Panic, no dogging, 2'0" door			
6320CF	Concealed vertical rod, Listed to UL10C for Fire, no dogging, 2'0" door	\$1832.00	\$1875.00	\$1967.00
6320CFLBR*	Concealed vertical rod, less bottom rod, Listed to UL10C for Fire, no dogging, 2'0" door			

For devices over 7' high, add \$25 per foot

*LBR FIRE RATED DEVICES MUST BE ORDERED IN PAIRS. One fire pin furnished per pair.

6300/6400
CONCEALED VERTICAL
ROD EXIT DEVICE

6300/6400 CONCEALED VERTICAL ROD EXIT DEVICE LIST PRICE

Effective July 3, 2023

6400C Concealed Vertical Rod Narrow Stile Exit Devices

PART	DESCRIPTION	630	613E/622/626	605/606/625
6400C	Concealed vertical rod, Listed to UL305 for Panic, hex key dogging, 3'0" door	\$1651.00	\$1694.00	\$1786.00
6400CLBR	Concealed vertical rod, less bottom rod, Listed to UL305 for Panic, hex key dogging, 3'0" door			
6400CF	Concealed vertical rod, Listed to UL10C for Fire, no dogging, 3'0" door	\$1813.00	\$1856.00	\$1948.00
6400CFLBR*	Concealed vertical rod, less bottom rod, Listed to UL10C for Fire, no dogging, 3'0" door			
6410C	Concealed vertical rod, Listed to UL305 for Panic, hex key dogging, 4'0" door	\$1697.00	\$1740.00	\$1832.00
6410CLBR	Concealed vertical rod, less bottom rod, Listed to UL305 for Panic, hex key dogging, 4'0" door			
6410CF	Concealed vertical rod, Listed to UL10C for Fire, no dogging, 4'0" door	\$1859.00	\$1902.00	\$1994.00
6410CFLBR*	Concealed vertical rod, less bottom rod, Listed to UL10C for Fire, no dogging, 4'0" door			
6420C	Concealed vertical rod, Listed to UL305 for Panic, no dogging, 2'0" door	\$1751.00	\$1794.00	\$1886.00
6420CLBR	Concealed vertical rod, less bottom rod, Listed to UL305 for Panic, no dogging, 2'0" door			
6420CF	Concealed vertical rod, Listed to UL10C for Fire, no dogging, 2'0" door	\$1913.00	\$1956.00	\$2048.00
6420CFLBR*	Concealed vertical rod, less bottom rod, Listed to UL10C for Fire, no dogging, 2'0" door			

For devices over 7' high, add \$25 per foot

***LBR FIRE RATED DEVICES MUST BE ORDERED IN PAIRS.** One fire pin furnished per pair.

6300/6400
CONCEALED VERTICAL
ROD EXIT DEVICE

6300/6400 CONCEALED VERTICAL ROD EXIT DEVICE LIST PRICE

Effective July 3, 2023

6300/6400 CVR Mechanical Options

PART	DESCRIPTION	EXIT DEVICE ADJUSTMENT
EC	End Cap Cover	\$26.00
TLA	Head Cover (Similar to 6200 Series)	
AM	Anti Microbial (630/626 only)	\$98.00
CD	Cylinder Dogging	\$76.00
LD	Less Dogging	-
SNB	Sex Nuts & Bolts	\$26.00
SHS	Tamper Proof Security Head Screws	\$54.00
LBR	Less Bottom Rod	-
LBR-FP	Less Bottom Rod with Fire Pin (used with fire rated pair)	-

6300/6400 CVR Electrified Options

PART	DESCRIPTION	LIST PRICE
AL	Alarmed Exit	\$415.00
LM	Latch Bolt Monitoring	\$286.00
MLR	Motorized Latch Retraction	\$1030.00
SS	Signal Switch - Request to Exit and Monitoring	\$215.00
ALHW	Alarmed Exit with Hard Wire Power and Relay	\$580.00
ISMC	Industry Standard Molex Connector (order in addition to other electrified options)	\$108.00

- 1: Electrified options not available on 24" device.
- 2: For the MLR Motorized Latch Retraction option: 3 ft devices, maximum cut is 3". 4 ft devices, maximum cut is 9".
- 3: For the Alarm option: 3 ft devices, maximum cut is 2". 4 ft devices, maximum cut is 8".

6300/6400
CONCEALED VERTICAL
ROD EXIT DEVICE

6300M SERIES

Mortise Exit Device



ASSEMBLED
IN THE USA

6300M Wide Stile Panic & Fire Rated



TLA Head Cover

Optional head cover
*630 Finish only



Specifications

Rail	• Extruded aluminum
Latch	• Stainless steel dead locking with 3/4" throw
Hand	• Field reversible
Dogging	• Hex key dogging standard • Cylinder dogging optional • Dogging not available for fire labeled devices
Minimum Stile Width	• 5"
Door Thickness	• 1-3/4" - 2" (Consult factory for other)
Door Width	• 24", 36", 48" standard
Door Height	• Panic - Up to 10' • Fire - See fire ratings charts page 146
Strike Options	• Default ASA (4-7/8")
Finishes	• 605 - Polished Brass, 606 - Satin Brass, 613E - Dark Oxidized Satin Bronze, 622 - Flat Black, 626 - Satin Chrome, 630 - Satin Stainless Steel • Optional Anti Microbial Coating available on 626, 630
Fasteners	• Includes machine screws and wood screws • SNB Optional
Warranty	• Ten (10) year limited warranty
Electrified Options	• Motorized Latch Retraction • Request to Exit/Signal Switch • Alarmed Exit • Latch Bolt Monitor • ISMC Connectors
Certifications: Compliances: Listings:	• Listed for UL 305 "Panic", listed for UL 10C "Fire Exit Hardware" up to 90 minutes. • Complies with ADA (Americans with Disabilities Act) and ICC/ANSI 117.1 for Accessible and Usable Buildings • Meets requirements of the BAA as a COTS product manufactured in the United States

6300 MORTISE EXIT DEVICE

LIST PRICE

Effective July 3, 2023

How to Order

Series	For Door Width	Device Type	Rating	Finish	Options	Electrified Options
63	00	M	--	630	--	--
63 - Wide Stile Device	00 - 36" Door 10 - 48" Door 20 - 24" Door	M - Wide Stile Mortise Device*	Blank - Panic Rated	605 – Bright Brass 606 – Satin Brass 613E – Dark Bronze 622 – Satin Black 625 – Bright Chrome 626 – Satin Chrome 630 – Satin Stainless	Dogging (Panic Rated Only): Blank - Hex Key Dogging CD - Cylinder Dogging LD - Less Dogging* EC - End Cap Cover TLA - Head Cover SNB - Sex Nuts & Bolts AM - Anti-Microbial SHS - Security Head Screws	MLR - Motorized Latch Retr. AL - Alarm Kit* SS - Signal Switch on touch bar LM - Latchbolt Monitor ISMC - Industry Standard Molex Connector ALHW - Alarm kit hard wired

*Mortise in wide stile device only

*Multiple Selections Allowed
*Dogging options only apply to Panic Rated

*MLR can be combined with LM & SS
*AL can be combined with LM
*MLR and AL cannot be combined
*ISMC available on all
*AL - specify handing

6300 MORTISE EXIT DEVICE

6300M Mortise Wide Stile Exit Devices

PART	DESCRIPTION	630	613E/622/626	605/606/625
6300M	Mortise wide stile exit, Listed to UL305 for Panic, hex key dogging, 3'0" door width	\$1510.00	\$1553.00	\$1645.00
6300MF	Mortise wide stile exit, Listed to UL10C for Fire, 3'0" door width	\$1672.00	\$1715.00	\$1807.00
6310M	Mortise wide stile exit, Listed to UL305 for Panic, hex key dogging, 4'0" door width	\$1556.00	\$1599.00	\$1691.00
6310MF	Mortise wide stile exit, Listed to UL10C for Fire, 4'0" door width	\$1718.00	\$1761.00	\$1853.00
6320M	Mortise wide stile exit, Listed to UL305 for Panic, no dogging, 2'0" door	\$1610.00	\$1653.00	\$1745.00
6320MF	Mortise wide stile exit, Listed to UL10C for Fire, no dogging 2'0" door	\$1772.00	\$1815.00	\$1907.00

6300 MORTISE EXIT DEVICE

LIST PRICE

Effective July 3, 2023

6300M Mortise Wide Stile Mechanical Options

PART	DESCRIPTION	EXIT DEVICE ADJUSTMENT
EC	End Cap Cover	\$26.00
TLA	Head Cover (Similar to 6200 Series)	
AM	Anti Microbial (630/626 only)	\$98.00
CD	Cylinder Dogging	\$76.00
LD	Less Dogging	-
SNB	Sex Nuts & Bolts	\$26.00
SHS	Tamper Proof Security Head Screws	\$54.00

6300M Mortise Wide Stile Electrified Options

PART	DESCRIPTION	LIST PRICE
AL	Alarmed Exit	\$415.00
LM	Latch Bolt Monitoring	\$286.00
MLR	Motorized Latch Retraction	\$1030.00
SS	Signal Switch - Request to Exit and Monitoring	\$215.00
ALHW	Alarmed Exit with Hard Wire Power and Relay	\$580.00
ISMC	Industry Standard Molex Connector (order in addition to other electrified options)	\$108.00

1: Electrified options not available on 24" device.

2: For the MLR Motorized Latch Retraction option: 3 ft devices, maximum cut is 3". 4 ft devices, maximum cut is 9".

3: For the Alarm option: 3 ft devices, maximum cut is 2". 4 ft devices, maximum cut is 8".

6300
MORTISE EXIT DEVICE

6300D SERIES

Dummy Exit Device



ASSEMBLED
IN THE USA

6300D Dummy

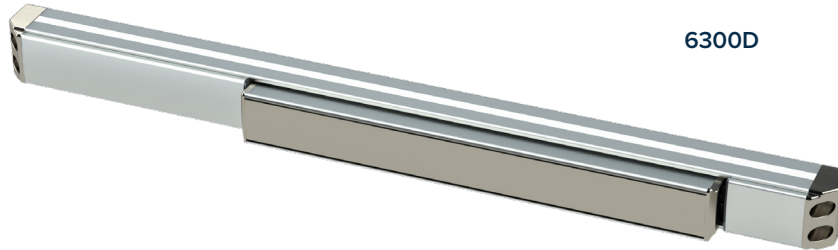

6300D



Specifications

Rail	• Extruded aluminum
Hand	• Device is non-handed
Dogging	• Dogging standard • Active push bar, dog to make inactive
Minimum Stile Width	• 3"
Door Thickness	• 1-3/4" - 2" (Consult factory for other)
Door Width	• 24", 36", 48" standard
Finishes	• 605 - Polished Brass, 606 - Satin Brass, 613E - Dark Bronze, 622 - Flat Black, 626 - Satin Chrome, 630 - Satin Stainless Steel • Optional Anti Microbial Coating available on 626, 630
Fasteners	• Includes machine and wood screws • SNB Optional
Warranty	• Ten (10) year limited warranty
Electrified Options	• Request to Exit/Signal Switch • ISMC Connectors
Certifications: Compliances: Listings:	• Complies with ADA (Americans with Disabilities Act) and ICC/ANSI 117.1 for Accessible and Usable Buildings • Meets requirements of the BAA as a COTS product manufactured in the United States

6300 DUMMY EXIT DEVICE

LIST PRICE
Effective July 3, 2023

How to Order

Series	For Door Width	Device Type	Finish	Options
63	00	D	630	--
63 - Wide Stile Device	00 - 36" Door 10 - 48" Door 20 - 24" Door	D - Dummy Device	605 – Bright Brass 606 – Satin Brass 613E – Dark Bronze 622 – Satin Black 625 – Bright Chrome 626 – Satin Chrome 630 – Satin Stainless	Dogging SS - Signal switch on touch bar

6300D Dummy Exit Devices

PART	DESCRIPTION	630	613E/622/626	605/606/625
6300D	Dummy, 3'0" door	\$902.00	\$945.00	\$1037.00
6310D	Dummy, 4'0" door	\$948.00	\$991.00	\$1083.00
6320D	Dummy, 2'0" door	\$1002.00	\$1045.00	\$1137.00

MORTISE EXIT DEVICE
6300

6300D Dummy Mechanical Options

PART	DESCRIPTION	EXIT DEVICE ADJUSTMENT
EC	End Cap Cover	\$26.00
SNB	Sex Nuts & Bolts	
SHS	Tamper Proof Security Head Screws	\$54.00

6300D Dummy Electrified Options

PART	DESCRIPTION	EXIT DEVICE ADJUSTMENT
SS	Signal Switch - Request to Exit and Monitoring	\$215.00

6300RF / 6400RF Rim Devices

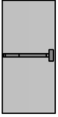
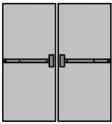
		RATING	MAX OPENING	APPLICATION
	Single Door	3 Hour Rated	4' x 10' Door	
	Double Door with 9300F Mullion	3 Hour Rated	8' x 8' Pair	Single Egress Pairs (Swing Same Direction)

6300VF / 6400VF Surface Vertical Devices

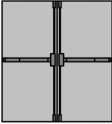
		RATING	MAX OPENING	APPLICATION
	Double Door Top/Btm Latches or Less Bottom Rod (LBR)	3 Hour Rated	8' x 10' Top/Btm Latches 8' x 8' Less Bottom Rod	Single Egress Pairs (Swing Same Direction)
	Double Door Top/Btm Latches or Less Bottom Rod (LBR)	3 Hour Rated	8' x 10' Top/Btm Latches 8' x 8' Less Bottom Rod	Double Egress Pairs (Swing Opposite Directions)

6300CF / 6400CF Concealed Vertical Devices

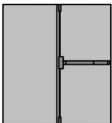
		RATING	MAX OPENING	APPLICATION
	Double Door Top/Btm Latches or Less Bottom Rod (LBR)	3 Hour Rated	8' x 8' Pair	Single Egress Pairs (Swing Same Direction)
	Double Door Top/Btm Latches or Less Bottom Rod (LBR)	3 Hour Rated	8' x 8' Pair	Double Egress Pairs (Swing Opposite Directions)

6300MF Mortise Devices

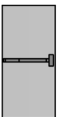
		RATING	MAX OPENING	APPLICATION
	Single Door	90 Minute Rated	4' x 8' Door	

6300/6400 DIMENSIONS

LIST PRICE

Effective July 3, 2023

6300 Series Wide Stile

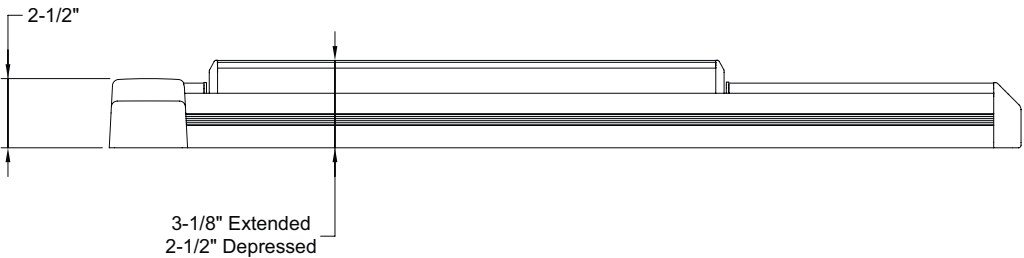
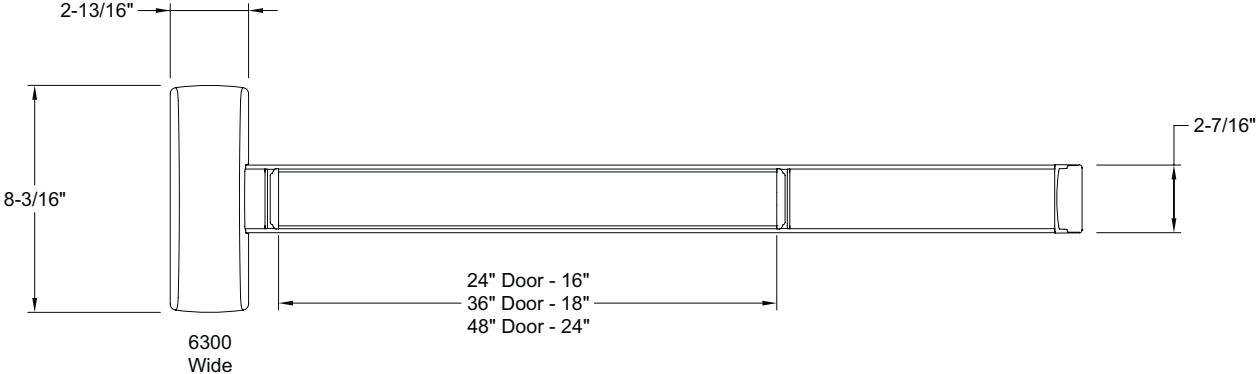

6400 Series Narrow Stile

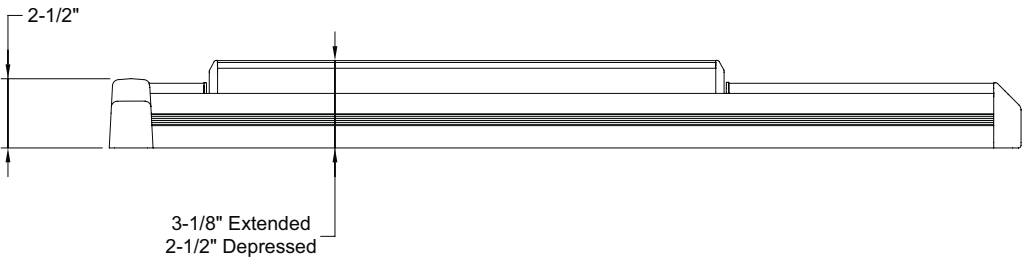
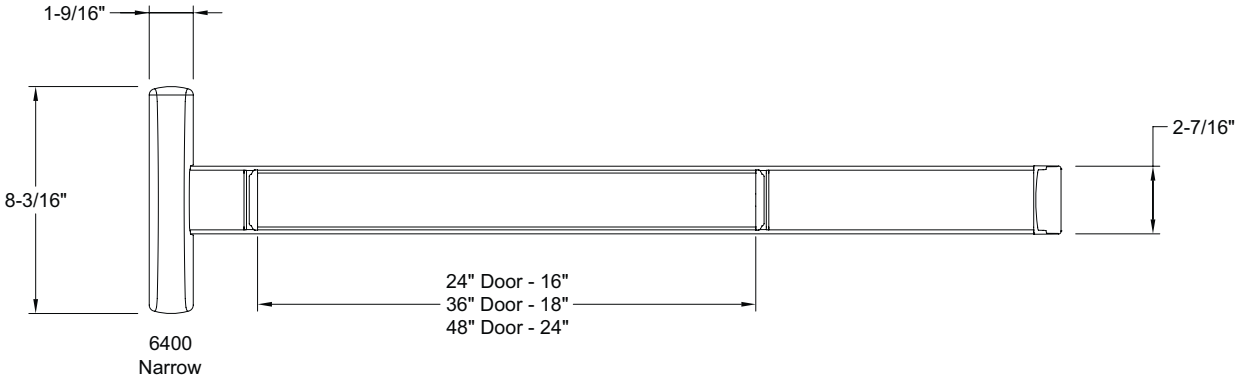

6300/6400 SERIES

LIST PRICE

Effective July 3, 2023

6300/6400 Series Door Width Chart

PART	DESCRIPTION	FOR DOOR	MAX CUT ^{1,2}
6300R-CD	6300 Rim Cylinder dogging	36"	6"
6300R	6300 Rim Hex Key dogging	36"	6"
6300RF	6300 Rim Fire	36"	8"
6300V-CD	6300 SVR Cylinder dogging	36"	6"
6300V	6300 SVR Hex Key dogging	36"	6"
6300VF	6300 SVR Fire	36"	8"
6300C	6300 CVR Hex Key dogging	36"	6"
6300CF	6300 CVR Fire	36"	8"
6310R-CD	6300 Rim Cylinder dogging	48"	12"
6310R	6300 Rim Hex Key dogging	48"	12"
6310RF	6300 Rim Fire	48"	14"
6310V-CD	6300 SVR Cylinder dogging	48"	12"
6310V	6300 SVR Hex Key dogging	48"	12"
6310VF	6300 SVR Fire	48"	14"

24" DEVICE
No cut
No electric options

1: For the MLR Motorized Latch Retraction option: 3 ft devices, maximum cut is 3". 4 ft devices, maximum cut is 9".

2: For the Alarm option: 3 ft devices, maximum cut is 2". 4 ft devices, maximum cut is 8".

6300 Wide Stile Cross Reference

MANUFACTURER	EXIT DEVICE SERIES/TYPE							
	RIM	RIM FIRE	VERTICAL ROD	VERTICAL ROD FIRE	CONCEALED VERTICAL ROD	CONCEALED VERTICAL ROD FIRE	MORTISE	MORTISE FIRE
PDQ	6300R	6300RF	6300V	6300VF	6300C	6300CF	6300M	6300MF
CORBIN	ED5200	ED5200A	ED5400	ED5400A	ED5860	ED5860B	ED5600	ED5600A
DORMA	9300	F9300	9400	F9400	9100	F9100	9500	F9500
FALCON	25-R	F-25-R	25-V	F-25-V	25-C	F-25-C	25-M	F-25-M
HAGER	4501 RIM	4501 RIM FR	4501 SVR	4501 SVR FR	4500 CVR	4500 CVR FR	4500 MOR	4500 MOR FR
SARGENT®	8800	12-8800	8700	12-8700	8600	12-8600	8900	12-8900
VON DUPRIN	98/99	98/99-F	98/9927	98/9927-F	98/9947	98/9947-F	98/9975	98/9975-F
YALE	7100	7100F	7110	7110F	7160	7160F	7130	7130F

6400 Narrow Stile Cross Reference

MANUFACTURER	EXIT DEVICE SERIES/TYPE					
	RIM	RIM FIRE	VERTICAL ROD	VERTICAL ROD FIRE	CONCEALED VERTICAL ROD	CONCEALED VERTICAL ROD FIRE
PDQ	6400R	6400RF	6400V	6400VF	6400C	6400CF
CORBIN	ED4200	ED4200MA	ED4400	ED4400MA	ED4800	ED4800MA
DORMA	9700	F9700	9800	F9800	9600	F9600
FALCON	24-R	F-24-R	24-V	F-24-V	24-C	F-24-C
HAGER	4601 RIM	4601 RIM FR	4601 SVR	4601 SVR FR	4601 CVR	4601 CVR FR
SARGENT®	8500	12-8500	N/A	N/A	8400	12-8400
VON DUPRIN	33A/35A	33A/35A-F	3327A/3527A	3327A/3527A-F	3347A/3547A	3347A/3547A-F
YALE	7200	7200F	7210	7210F	7220	7220F

The following options are available when ordering 6300/6400 devices.

LBR

Less Bottom Rod is available on SVR and CVR devices. This option deletes the bottom latch on applications where the bottom latch would impede access, or where a floor strike is not desired. LBR option is available on both panic and fire rated devices.

EC

End Cap Cover option provides a cover for the standard end cap. Can be used if the look is preferred, or to cover the end of the rail on devices that have been cut down.

TLA

The TLA head cover can be ordered to make the 6300 device better match the previous generation 6200 devices. The head cover is available in 630 finish only.

SNB

Order the SNB option if Sex Nuts are required. These are used on devices when trim is not used, and door construction is not sufficient to hold screws (such as wood or composite core).

SK

The Shim Kit is used to space the device out from the door. Shims are available in 1/8" and 1/4" thickness. Use multiple shims for additional clearance.

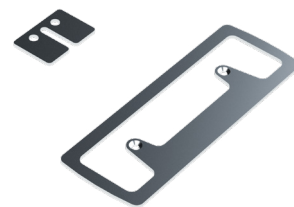

The following Rim Strike options are available when ordering 6300/6400 devices.

BS – Blade Stop Strike (631041) – Rim Device

This strike is used on aluminum store front doors with a 1 / 2" blade stop. Strike comes with a protective plate to latch rubbing on frame and required mounting hardware.

Strike is optional on both 6300 and 6400 devices.

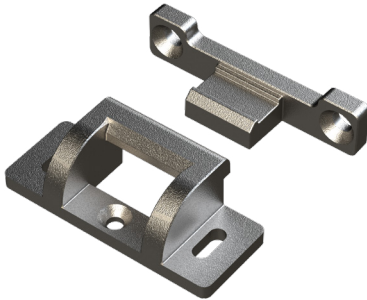

ML – Mullion Fire Strike (639080) – Rim Device

This strike must be used for fire labeled rim devices when used with the 9300F mullion. It is also used for windstorm HVHZ labeled devices.

(2) ML strikes are included with every fire rated mullion.

DD – Double Door Strike (631035) – Rim Device

This strike is used to mount a rim device on a pair of doors where one door is fixed by another means (e.g. Flush bolts, Surface bolts)

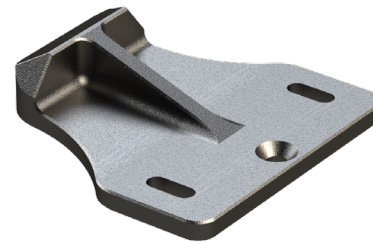

Rim Device Stile Width Chart

Order Option	Strike #	Application	6300 Min Stile	6400 Min Stile
Default Panic	639027	Standard Panic Labeled	4-1/4"	3-1/8"
Default Fire	639057	Standard Fire Labeled	4-1/4"	3-1/8"
Default Panic	639027	Panic Labeled Mullion	4-3/4"	3-5/8"
ML	639080	Fire Labeled Mullion	4-7/8"	3-3/4"
WS	639080	Windstorm	4-3/8"	3-1/4"
DD	631035	Double Door Strike	4-1/4"	3-1/8"
BS	631041	Panic Labeled Blade Stop	3-1/2"	2-1/8"

6300/6400 SERIES PARTS

LIST PRICE

Effective July 3, 2023

Parts

Panic Rated Head Chassis (for replacement only)	Specify		Price Each
	Wide Stile	Narrow Stile	
Rim	639001-R	649001-R	\$250.00
Vertical Rod	639001-V	649001-V	\$330.00
Concealed Vertical Rod	639001-C	649001-C	
Mortise	639001-M	-	
Mortise Lock Body	J163-finish	-	\$275.00

Fire Rated Head Chassis (for replacement only)	Specify		Price Each
	Wide Stile	Narrow Stile	
Rim	639001-RF	649001-RF	\$250.00
Vertical Rod	639001-V	649001-V	\$330.00
Concealed Vertical Rod	639001-V	649001-V	
Mortise	639001-M	-	
Mortise Lock Body	J163-finish	-	\$275.00

Latch Bolt Assembly *Does not include latchbolt cover	Specify	Price Each
Surface or Concealed Vertical Rod Top Latchbolt	639029	\$80.00
Surface or Concealed Vertical Rod Bottom Latchbolt	639030	\$120.00
Surface Vertical Rod Latchbolt mounting Bracket	631513	\$16.00
Concealed Vertical Rod Steel/Wood Door Latch Mounting Bracket	631511	
Less Bottom Rod Fire Bolt Kit	639720	\$170.00

Vertical Rod Parts	Specify	Price Each
Surface Vertical Rod Bottom Rod	631212SVRB-XXX*	\$55.00
Surface Vertical Rod Top Rod - 7' opening	631212SVRT-XXX*	
Surface Vertical Rod Top Rod- 8' opening	6312128SVR-XXX*	\$60.00
Surface Vertical Rod 3' Top Rod Extension	631212-36EXT-XXX*	\$55.00
Concealed Vertical Rod Bottom Rod	631212CVRB	
Concealed Vertical Rod Top Rod 7' opening	631212CVRT	
Concealed Vertical Rod Top Rod 8' opening	6312128CVR	\$60.00
Vertical Rod Connector	631205	\$28.00
Vertical Rod Extension Coupler	631206	
Concealed Vertical Rod End Link Assembly	639060	\$60.00

*Specify finish



Parts

Push Bar (specify finish)	Specify		Price Each
	3'	4'	
Device push bar	639703-36-XXX*	639703-48-XXX*	\$250.00
Push Bar faceplate	631030-18-XXX*	631030-24-XXX*	\$100.00

*Specify finish

Covers/Caps

Covers and Cap fasteners are listed separately

Standard Head/Chassis Cover (specify finish)	Specify		Price Each
	Wide Stile	Narrow Stile	
Rim	639704RW-XXX*	639704RN-XXX*	\$120.00
Vertical Rod	639704VW-XXX*	639704VN-XXX*	
Concealed Vertical Rod	639704BW-XXX*	639704BN-XXX*	
Mortise	639704BW-XXX*	-	
TLA Head/Chassis Cover	Specify		Price Each
	Wide Stile	Narrow Stile	
Rim	639705RW-630	639705RN-630	\$120.00
Vertical Rod	639705VW-630	639705VN-630	
Concealed Vertical Rod	639705BW-630	639705BN-630	
Mortise	639705BW-630	-	
SVR Latch Cover (specify finish)	Specify		Price Each
	Wide and Narrow Stile		
Latch cover for surface vertical rod top or bottom	631706-XXX		\$55.00
End Caps (specify finish) See fasteners section for screwpack	Specify		Price Each
	Wide and Narrow Stile		
End Cap	631032-XXX*		\$50.00
End Cap Cover	631707-XXX*		\$32.00
Miscellaneous	Specify		Price Each
	Wide and Narrow Stile		
SVR Rod Guide Assembly (sold with fastener)	639708-XXX*		\$40.00
Filler Plate Plastic End Cap	631034		\$5.00
Cover Bottom Plug for Surface Vertical LBR application	631222		

*Specify finish

Strikes & Shim's

Rim Strikes	Specify	Price Each
Rim Panic Strike	639709	\$35.00
Rim Fire Strike	639710	
Rim Blade Stop Strike	639711	\$110.00
Rim Mullion Fire / Windstorm Strike	639712	\$135.00
Rim Double Door Strike	639714	\$82.00
Rim Strike Shim's	Specify	Price Each
Rim Panic Strike Shim .100"	631126	\$14.00
Rim Fire Strike Shim .100"		
Rim Blade Stop Strike Shim .100"		
Rim Mullion Fire / Windstorm Strike Shim .100"	631619	\$32.00
Vertical Rod Strikes	Specify	Price Each
Surface & Concealed Vertical Rod Top Strike	639715	\$35.00
Surface & Concealed Vertical Rod Bottom Strike	639716	
Vertical Rod Strike Shim's	Specify	Price Each
Top Strike Shim 1/16"	631541	\$14.00
Mortise Exit Strikes	Specify	Price Each
Non Handed 6300M strike	631416	\$55.00

Device Shim Kits 1/8" Thickness	Specify		Price Each
	Wide Stile	Narrow Stile	
Rim	631125-830	631125-840	\$135.00
Surface Vertical Rod	631125-832	631125-842	
Concealed Vertical Rod	631125-830	631125-840	
Mortise	631125-820	-	
1/4" Thickness	Specify		Price Each
	Wide Stile	Narrow Stile	
Rim	631125-430	631125-440	\$165.00
Surface Vertical Rod	631125-432	631125-442	
Concealed Vertical Rod	631125-430	631125-430	
Mortise	631125-420	-	

Parts

Drill Guides	Specify	Price Each
	Wide Stile	
Standard Roller Rim Strike Drill Guide	631127	\$25.00
Mullion Rim Fire / Windstorm Drill Guide	631620	

Conversion Kits

Cylinder Dogging Conversion Kits (specify finish) *Cylinder and trim rings not included	Specify		Price Each
	Wide Stile	Narrow Stile	
3' Cylinder Dogging Conversion Kit	639701-3WC-XXX	639701-3NC-XXX	\$120.00
4' Cylinder Dogging Conversion Kit	639701-4WC-XXX	639701-4NC-XXX	
Collars for Cylinder Dogging (specify finish)	Specify		Price Each
	Wide Stile	Narrow Stile	
Tall Trim Ring / Spacer Reversible 5/8 Collar or 3/4" Spacer	631094-XXX	-	\$30.00
Short Trim Ring / Spacer Reversible No Height Collar or 1/4" Spacer	631093-XXX	-	\$18.00

Alarm Conversion Kits (specify finish) *Cylinder and trim rings not included	Specify		Price Each
	Wide Stile	Narrow Stile	
3' Panic Device	639702P-3WA-XXX	639702P-3NA-XXX	\$415.00
4' Panic Device	639702P-4WA-XXX	639702P-4NA-XXX	
3' Fire Device	639702F-3WA-XXX	639702F-3NA-XXX	
4' Fire Device	639702F-4WA-XXX	639702F-4NA-XXX	

Cylinder Dogging Application Chart

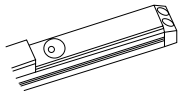
TRIM TYPE	FUNCTION	IMAGE	STANDARD CYLINDER	BEST SFIC	SCHLAGE STYLE LFIC
CYLINDER DOGGING	All Devices		1-1/8" Mortise Cylinder 631093 Trim Ring Yale Cam	SFIC 7 pin housing (2) 631093 Trim Rings Yale Cam	LFIC housing 631094 Collar (5/8") Yale Cam

Parts

Replacement Dogging Parts	Specify	Price Each
Hex Dogging Mechanism	639022C	\$82.00
Cylinder Dogging Mechanism	639022H	
Cylinder anti-rotation plate (alarm kit & cyl dogging)	631095	\$10.00
Cylinder retaining nut (alarm kit, cylinder dogging, 6N, 6W)	88644	
Dogging Key - 3/16" with Loop	631113	\$14.00
Cylinder Nut Tool	88875	\$150.00

Screwpacks	Specify	Price Each
Device Screwpack	639043	\$16.00
Surface Vertical Rod Connector Screwpack	639044	
Surface Vertical Rod Latch Screwpack	639045	
Concealed Vertical Rod Latch Screwpack	639049	
Rim Strike Screwpack	639050	\$6.00
Vertical Rod Strike Screwpack (SVR/CVR)	639054	\$16.00
Sex Bolt (SNB) 4 Pack 626/630	639053-04	\$45.00
Sex Bolt (SNB) 4 Pack 622/613E	639053-H	
Sex Bolt (SNB) 4 Pack 605/606	639053-08	
Screwpack, Head Cover or SVR Latch Cover	639721	\$16.00
Screwpack, End Cap Cover	639722	

Electrification	Specify	Price Each
Signal Switch (for panic rated device)	639718	\$215.00
Signal Switch (for fire rated device)	639719	
Motorized Latch Retraction	639717	\$1255.00
Wire Routing Guide	639067	\$60.00
Latchbolt monitoring	contact factory	\$285.00

6300/6400 SERIES

Wide Stile/Narrow Stile Exit Device Trims

Trims are non-handed and use simple door prep based on a 2 hole bolt pattern with 7" centers, or a 4 hole bolt pattern with 7"x1-3/8" centers.

Narrow escutcheons work with both wide and narrow stile devices. Wide escutcheons work only with wide stile devices.



6N Narrow Escutcheon - A narrow profile escutcheon for 6300 or 6400 device. Available in 6 lever styles, and in 6 functions. Use with narrow stile devices or a wide stile device when a slimmer look is desired.



6W Wide Escutcheon - A wide escutcheon for the 6300 device. Available in 6 lever styles, and 5 functions - including electric locking. Use with wide stile devices, when a more substantial look is desired, or for retrofit where covering existing holes is important.

**Not compatible with 6400 narrow stile devices*



6T Thumb Latch - A grip pull with a thumb latch for 6300 or 6400 devices. Available in 4 functions.

**Not compatible with 6400C narrow stile devices.*



6P Pull Plate - Stainless Steel pull plate for 6300 device.

**Not compatible with 6400 narrow stile devices.*



6G Grip Pull - A grip pull for 6300 or 6400 devices. Made of stainless steel, this grip pull is available in 2 functions.



6S Rose Trim - Rose trim that fits into standard 161 prepped door with thru bolts. Works with 6300 rim, SVR and CVR devices. Available in 3 lever styles and in 4 functions.

**Not compatible with 6400 narrow stile devices*



6C Cylinder only - Order this trim option for cylinder only, NightLatch (F03) Function. Includes rim cylinder or *IC rim housing, collar, and required mounting hardware.

**IC core sold separately*

Lever Styles

PHL



BSN



MIA



ORL



CHI



LAX

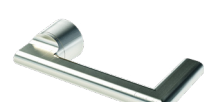

6300/6400 SERIES TRIMS

LIST PRICE

Effective July 3, 2023

How to Order

TRIM TYPE	LEVER	FINISH	OPTIONS	CYLINDER TYPE	KEYWAY	KEYING
6N08	PHL	630	AM	D	SCC	KD
Narrow Escutcheon	PHL – Philadelphia	605 – Bright Brass	AM - Antimicrobial	D Default	SCC – Schlage C	KD – Keyed Different
6N01/6NM01 – Narrow, Blank (No lever)	BSN – Boston	606 – Satin Brass	TC - Tactile Abrasive Coating	L Less Cylinder	OTHERS – See Keyway Table	KA – Keyed Like
6N02/6NM02 – Narrow, Fixed Lever	MIA – Miami	613E – Dark Bronze	TD4 - 2-1/2" - 2-3/4" thick application	SF6 Lock is SFIC prepped w/ 6 pin core		KO – Zero Bitted
6N03 – Narrow, Cylinder Only (No Lever) Night Latch	*CHI – Chicago	622 – Satin Black	TD5 - Up to 3" thick application	SF7 Lock is SFIC prepped w/ 7 pin core		MK – Master Keyed
6N08/6NM08 – Narrow, Classroom	*ORL – Orlando	625 – Bright Chrome		SFL Lock is SFIC prepped but less core		CMK – Construction Master Keyed
6N09/6NM09 – Narrow Storeroom	*LAX – Los Angeles	626 – Satin Chrome		SFC Lock is SFIC prepped w/ construction core		GMK – Grand Master Keyed
6N14/6NM14 – Narrow Passage	*Not available with S Trim	630 – Satin Stainless		SFP Lock is SFIC prepped w/ plastic construction core		
Wide Escutcheon				LF6 Lock is Schlage LFIC prepped w/ Schlage core		
6W02/6WM02 – Wide, Fixed Lever				LFL Lock is Schlage LFIC prepped but less core		
6W08/6WM08 – Wide, Classroom				LFC Lock is Schlage LFIC prepped w/ construction core		
6W09/6WM09 – Wide, Storeroom						
6W14/6WM14 – Wide, Passage						
6W99/6WM99 – Electrified						
Sectional/Rose						
6S02 – Sectional, Rigid Lever						
6S08 – Sectional, Classroom						
6S09 – Sectional, Storeroom						
6S14 – Sectional, Passage						
Thumb Latch						
6T02 – Thumb Latch, Dummy, Rigid thumb piece						
6T05 – Thumb Latch, Classroom						
6T06 – Thumb Latch, Storeroom						
6T15 – Thumb Latch, Passage						
Pull Plate						
6P03 – Pull Plate, Cylinder						
Grip Pull						
6G02/6GM02 – Pull only						
6G03/6GM03 – Night Latch						
Cylinder Only						
6C03/6CM03 – Cylinder Only						

6300/6400
EXIT DEVICE TRIMS



6N
Narrow Escutcheon
01, 02, 03, 08, 09, 14



6W
Wide Escutcheon
02, 08, 09, 14, 99



6G
Grip Pull
02, 03



6T
Thumb Latch
02, 05, 06, 15



6P
Pull Plate
02, 03



6S
Sectional/Rose
02, 08, 09, 14



6C
Cylinder Only
03

6300/6400 SERIES TRIMS

LIST PRICE

Effective July 3, 2023

6N Functions

01 Blank

Blank Escutcheon



02 Pull Only

Entrance/Pull only when device is dogged. Fixed lever.

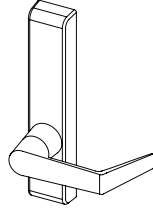

03 Night Latch

Entrance when latch retracted by key. Key removable only when locked.

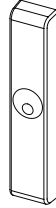

08 Classroom

Key locks or unlocks lever.

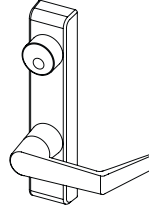

09 Storeroom

Entrance by lever when unlocked by key. Key removable only when locked.

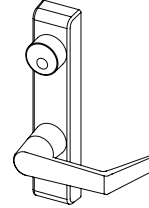

14 Passage

Entrance by lever, always unlocked.

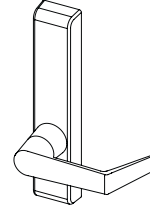

6N Lever Styles

PHL

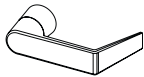

BSN



MIA

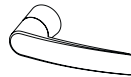

ORL

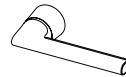

CHI

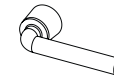

LAX

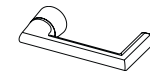

Applicable Devices

- 6400R Narrow Rim Device
- 6400V Narrow Surface Vertical Device
- 6400C Narrow Concealed Vertical Device
- 6300R Wide Stile Rim Device
- 6300V Wide Surface Vertical Device
- 6300C Wide Concealed Vertical Device
- 6300M Wide Mortise Device (Except 03 function)

CYLINDER OPTIONS	ICON	LOCK ADJUSTMENT
SFL		N/C
LFL		
D		

IC Core not included.

6N Narrow Stile Trim

6N	APPLICATION	FUNCTION	DESCRIPTION	LEVER	630	605/606/ 613E/622/625/626
	Rim Surface Vertical Rod Concealed Vertical Rod	01	Blank (no lever)	PHL, BSN, MIA, ORL, CHI, LAX	\$109.00	\$125.00
		02	Dummy Trim (Rigid Lever)		\$384.00	\$400.00
		03	Night Latch (no lever)		\$171.00	\$187.00
		08	Classroom w/ Lever		\$446.00	\$462.00
		09	Storeroom w/ Lever			
		14	Passage w Lever		\$384.00	\$400.00

6300/6400
EXIT DEVICE TRIMS

6300/6400 SERIES TRIMS

LIST PRICE

Effective July 3, 2023

6NM Narrow Stile Mortise Trim

6N	APPLICATION	FUNCTION	DESCRIPTION	LEVER	630	605/606/ 613E/622/625/626
<p>NARROW ESCUTCHEON</p> 	Mortise	M01	Blank (no lever)	PHL, BSN, MIA, ORL, CHI, LAX	\$109.00	\$125.00
		M02	Dummy Trim (Rigid Lever)		\$384.00	\$400.00
		M08	Classroom w/ Lever		\$446.00	\$462.00
		M09	Storeroom w/ Lever			
		M14	Passage w Lever		\$384.00	\$400.00

6300/6400
EXIT DEVICE TRIMS

6300/6400 SERIES TRIMS

LIST PRICE
Effective July 3, 2023

6W Functions

02 Pull Only

Entrance/Pull only when device is dogged. Fixed lever.

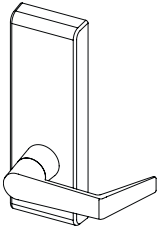

08 Classroom

Key locks or unlocks lever. Conversion kit included to convert locking function.

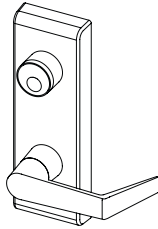

09 Storeroom

Entrance by lever when unlocked by key. Key removable only when locked.

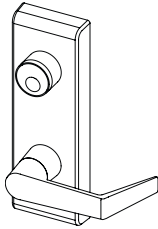

14 Passage

Entrance by lever, always unlocked.

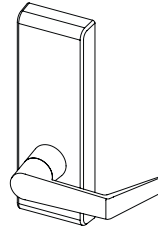

99 Electrified

Locked/Unlocked electronically. FS/FSF configurable. Entry by key. Key does not change lock state.

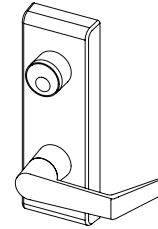

6W Lever Styles

PHL

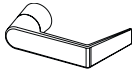

BSN



MIA

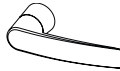

ORL

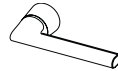

CHI

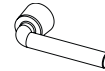

LAX

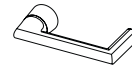

Applicable Devices

- 6300R Wide Stile Rim Device
- 6300V Wide Surface Vertical Device
- 6300C Wide Concealed Vertical Device
- 6300M Wide Mortise Device

CYLINDER OPTIONS	ICON	LOCK ADJUSTMENT
SFL		N/C
LFL		
D		

IC Core not included.

6W Wide Stile Trim

6W	APPLICATION	FUNCTION	DESCRIPTION	LEVER	630	605/606/ 613E/622/625/626
	Rim Surface Vertical Rod Concealed Vertical Rod	02	Dummy Trim (Rigid Lever)	PHL, BSN, MIA, ORL, CHI, LAX	\$415.00	\$431.00
		08	Classroom w/ Lever		\$478.00	\$494.00
		09	Storeroom w/ Lever		\$415.00	\$431.00
		14	Passage w/ Lever		\$867.00	\$883.00
		99	Electrified Storeroom			

6W08 and 6W09 includes conversion kit from factory (6W08 to 6W09 or 6W09 to 6W08)

6300/6400 SERIES TRIMS

LIST PRICE

Effective July 3, 2023

6WM Wide Stile Mortise Trim

6W	APPLICATION	FUNCTION	DESCRIPTION	LEVER	630	605/606/ 613E/622/625/626
	Mortise	M02	Dummy Trim (Rigid Lever)	PHL, BSN, MIA, ORL, CHI, LAX	\$415.00	\$431.00
		M08	Classroom w/ Lever		\$478.00	\$494.00
		M09	Storeroom w/ Lever		\$415.00	\$431.00
		M14	Passage w/ Lever		\$867.00	\$883.00
		M99	Electrified Storeroom			

6W08 and 6W09 includes conversion kit from factory (6W08 to 6W09 or 6W09 to 6W08)

6T Functions

02 Pull Only

Entrance/Pull only when device is dogged. Rigid Thumb piece.

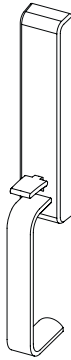

05 Classroom

Key locks or unlocks thumb piece.

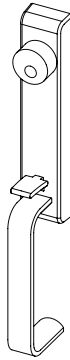

06 Storeroom

Entrance by thumb piece when released by key. Key removable only when locked.

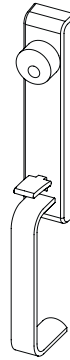

15 Passage

Entrance by lever when unlocked by key. Key removable only when locked.

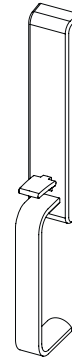

Applicable Devices

- 6300R Wide Stile Rim Device
- 6300V Wide Surface Vertical Device
- 6300C Wide Stile Concealed Vertical Device
- 6400R Narrow Rim Device
- 6400V Narrow Surface Vertical Device
- 6400C Narrow Concealed Vertical Device

6T Thumb Latch Trim

6T	APPLICATION	FUNCTION	DESCRIPTION	630	613E/622	CYLINDER OPTIONS	ICON	LOCK ADJUSTMENT
THUMB LATCH 	Rim Surface Vertical Rod Concealed Vertical Rod	02	Dummy. Rigid thumb piece.	\$345.00	\$361.00	SFL		N/C
		05	Classroom	\$370.00	\$386.00	LFL		
		06	Storeroom			D		
		15	Passage	\$345.00	\$361.00			

IC Core not included.

6P Functions

03 Night Latch

Entrance when latch retracted by key. Key removable only when locked.

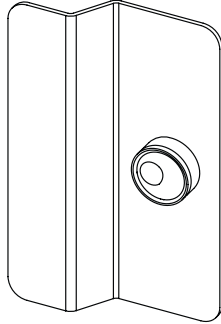



Applicable Devices

- 6300R Wide Stile Rim Device
- 6300V Wide Surface Vertical Device
- 6300C Wide Concealed Vertical Device

6P Pull Trim

6P	APPLICATION	FUNCTION	DESCRIPTION	630	613E/622
<p>PULL TRIM</p> 	<p>Rim</p> <p>Surface Vertical Rod</p> <p>Concealed Vertical Rod</p>	03	Night Latch	\$158.00	\$174.00

CYLINDER OPTIONS	ICON	LOCK ADJUSTMENT
SFL		N/C
LFL		
D		

IC Core not included.

6300/6400 SERIES TRIMS

LIST PRICE

Effective July 3, 2023

6G Functions

02 Pull Only

Entrance/Pull only when device is dogged.



03 Night Latch

Entrance when latch retracted by key. Key removable only when locked.

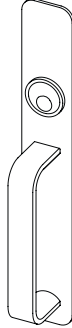

M03 Mortise Storeroom

Entrance when latch retracted by key. Key removable only when locked.

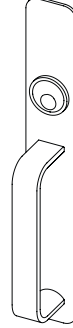



Applicable Devices

- 6300R Wide Stile Rim Device
- 6300V Wide Surface Vertical Device
- 6300C Wide Concealed Vertical Device
- 6300M Wide Mortise Device
- 6400R Narrow Rim Device
- 6400V Narrow Surface Vertical Device
- 6400C Narrow Concealed Vertical Device

6G Grip Pull Trim

6G	APPLICATION	FUNCTION	DESCRIPTION	630	613E/622
GRIP PULL 	Rim Surface Vertical Rod Concealed Vertical Rod	02	Dummy Trim (Grip Pull only)	\$166.00	\$182.00
		03	Night Latch	\$220.00	\$236.00

CYLINDER OPTIONS	ICON	LOCK ADJUSTMENT
SFL		N/C
LFL		
D		

IC Core not included.

6GM Grip Pull Mortise Trim

6G	APPLICATION	FUNCTION	DESCRIPTION	630	613E/622
GRIP PULL 	Mortise	M02	Dummy Trim (Grip Pull only)	\$166.00	\$182.00
		M03	Night Latch	\$220.00	\$236.00

6300/6400 SERIES TRIMS

LIST PRICE

Effective July 3, 2023

6S Functions

02 Pull Only

Entrance/Pull only when device is dogged. Lever is fixed.

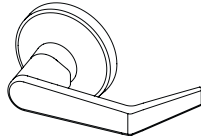

08 Classroom

Key locks or unlocks lever.

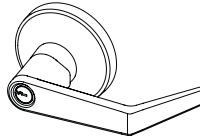

09 Storeroom

Entrance by lever when key inserted. Key removable only when locked.

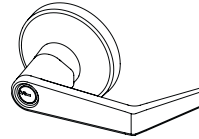

14 Passage

Entrance by lever. Always unlocked.

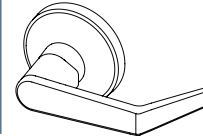

6S Lever Styles

PHL

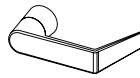

BSN



MIA





Applicable Devices

- 6300R Wide Stile Rim Device
- 6300V Wide Surface Vertical Device
- 6300C Wide Concealed Vertical Device

6S Sectional Trim

6S	APPLICATION	FUNCTION	DESCRIPTION	LEVER	626	605/606 613E/622/ 630
SECTIONAL LEVER 	Rim Surface Vertical Rod Concealed Vertical Rod	02	Dummy Trim	BSN, MIA, PHL	\$220.00	\$236.00
		08	Classroom w/ Lever		\$277.00	\$293.00
		09	Storeroom w/ Lever			
		14	Passage w/ Lever		\$250.00	\$266.00

CYLINDER OPTIONS	ICON	LOCK ADJUSTMENT
SFL		N/C
LFL		
D		

IC Core not included.

Note: LFL Prep only available in PHL lever

Note: 6S Trim shipped after March 2022 is not compatible with 6200 series exit devices. Contact factory for retrofit trim.

6300/6400
EXIT DEVICE TRIMS

6300/6400 SERIES TRIMS

LIST PRICE

Effective July 3, 2023

6C Cylinder Only



6C Cylinder Only - Order this trim option for cylinder only, Night Latch (F03) Function. Includes rim cylinder or *IC rim housing, collar, and required mounting hardware.





*IC core sold separately

How to Order

Series	Function	Finish	Cylinder Type	Keying
6C	03	630	D	SCC
6C - Cylinder Only - 6300/6400 Device	03 - Night Latch (Rim) M03 - Night Latch (Mortise)	605 – Bright Brass 606 – Satin Brass 613E – Dark Bronze 622 – Satin Black 625 – Bright Chrome 626 – Satin Chrome 630 - Stainless Steel	D Default L Less Cylinder SF6 - SFIC prepped w/ 6 pin core SF7 - SFIC prepped w/ 7 pin core SFL - SFIC prepped but less core SFC - SFIC prepped w/ construction core SFP - SFIC prepped w/ plastic construction core LF6 - Schlage LFIC prepped w/ Schlage core LFL - Schlage LFIC prepped but less core LFC - Schlage LFIC prepped w/ construction core	SCC – Schlage C Others – See Keyway Table Page

6300/6400
EXIT DEVICE TRIMS

6C Cylinder Only

6C	APPLICATION	FUNCTION	DESCRIPTION	605/606/613E/ 619/622/625 626/630	CYLINDER OPTIONS	ICON	LOCK ADJUSTMENT
CYLINDER ONLY 	Rim Surface Vertical Rod Concealed Vertical Rod	03	6C - Cylinder Only - 6300/6400 Device	\$133.00	SFL		N/C
					LFL		
					D		

6CM Cylinder Only

6C	APPLICATION	FUNCTION	DESCRIPTION	605/606/613E/ 622/625 626/630
CYLINDER ONLY 	Mortise	M03	6CM - Cylinder Only - 6300 Mortise Device	\$133.00

IC Core not included.

6300/6400 TRIM DIMENSIONS

LIST PRICE

Effective July 3, 2023

Trim Dimensions

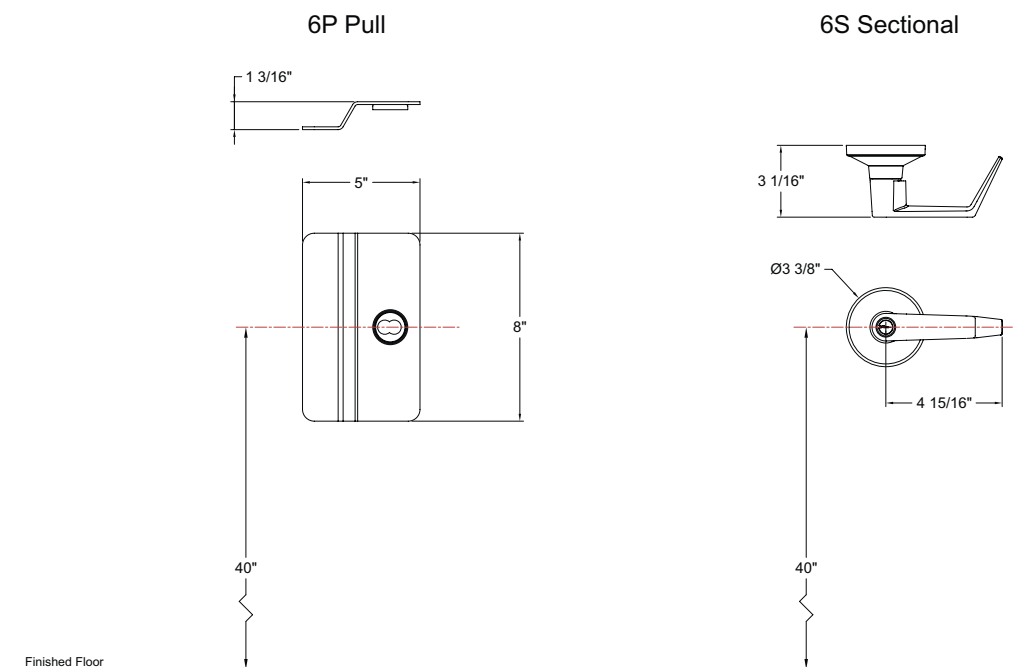
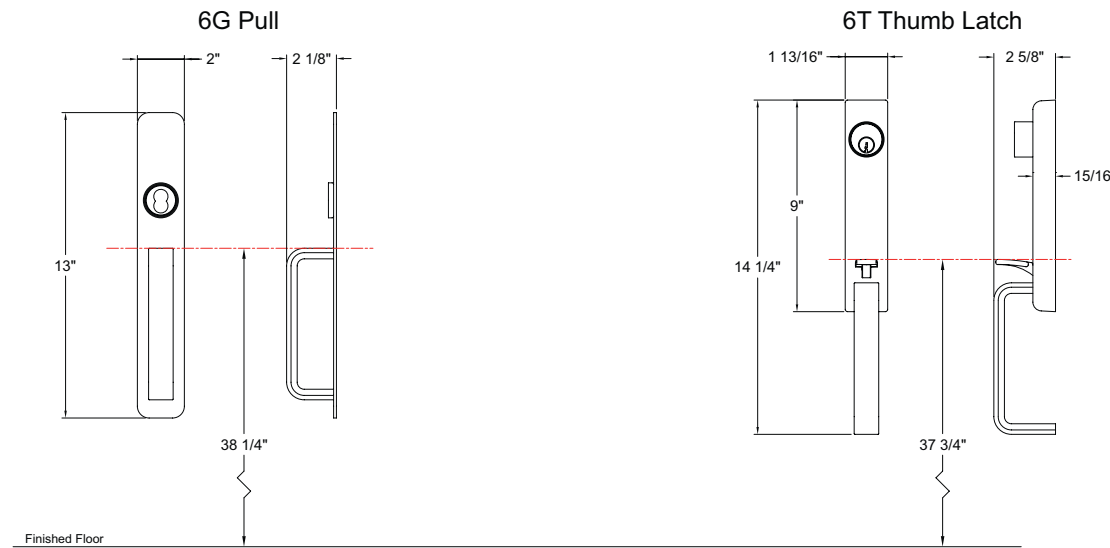
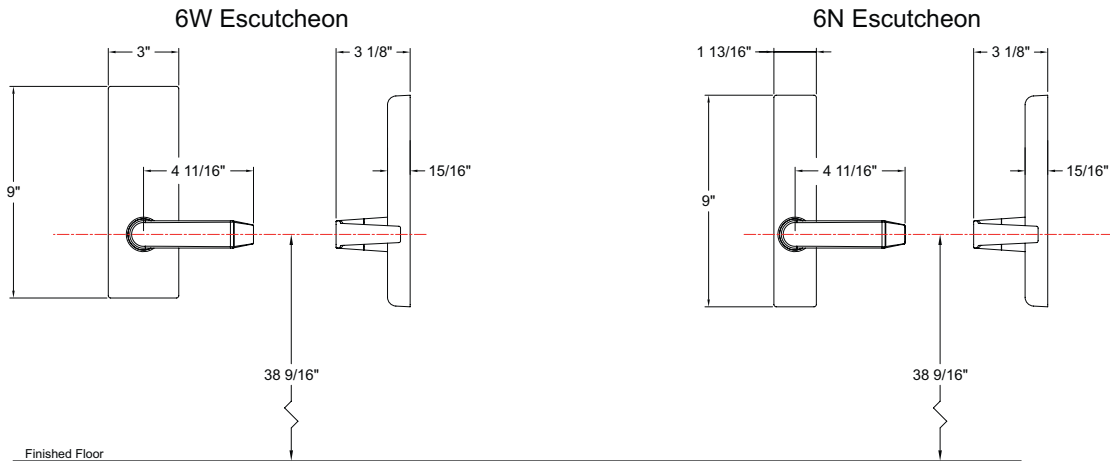

6300/6400
EXIT DEVICE TRIMS

Options

TRIM	PART	DESCRIPTION	TRIM ADJUSTMENT
All Trims	AM	Antimicrobial coating applied to tactile surfaces	\$90.00
6W, 6T, 6G, 6P	TD4	Trim adapted to accommodate 2-1/2"-2-3/4" thick doors	\$42.00
	TD5	Trim adapted to accommodate up to 3" thick doors	

Keyways

Conventional Cylinder		Small Format Interchangeable Core		Large Format Interchangeable Core	
Keyway	PDQ Keyway Designator	Keyway (BEST Compatible)	PDQ Keyway Designator	Keyway (Schlage Compatible)	PDQ Keyway Designator
Schlage C (Default)	SCC	BEST A (Default), B, C, D, E, F, G, H, J, K, L, M, Q, R, WA, WB, WG, WH, TB, TD, TE, R	A (Default), B, C, D, E, F, G, H, J, K, L, M, Q, R, WA, WB, WG, WH, TB, TD, TE, R	Schlage C (Default)	SCC (Default)
PDQ Restricted	TA				
Arrow AR1	ARA				
Corbin 59A1	CO59A1				
Corbin 60	CO6				
Corbin L4	CL4				
Russwin D1	RUD			PDQ Exclusive	PDQ1
Russwin 981	RUD981				PDQ2
Schlage E	SCE			PDQ Exclusive and Restricted	PDQ3
Schlage C	SCC				
Schlage C-K	SCC-K				
Sargent LA	SAL				
Sargent RA-RC	RA-RC				
Yale E1R	YA8				
Yale GA	GA				
Falcon E-R	FAL				
Kwikset	KW				

Keying

Description	PDQ Keying Designator
Keyed Different (Default)	KD
Keyed Alike	KA
"O" Zero Bitted	KO
Master Keyed	MK
Construction Master Keyed	CMK
Grand Master Keyed	GMK

Keyways and Cylinders

PDQ KEYWAY	COMPATIBLE WITH	SOLD WITH LOCK
AR1	Arrow / AR1	N/C
CO59A1	Corbin / 59A1	
CO6	Corbin / 60	
CL4	Corbin / L4	
RUD	Russwin / D1	
SCE	Schlage / E	
SCC	Schlage / C	
SCC-K	Schlage / C-K	
SAL	Sargent / LA	
RA-RC	Sargent / RA-RC	
YA8	Yale / E1R	
GA	Yale / GA	
FAL	Falcon / E-R	
KW	Kwikset	
TA	PDQ / TA (Restricted. Limited to Grandmaster systems w/4 masters)	
Dummy	—	
T-Turn	—	
L	Less Cylinder	

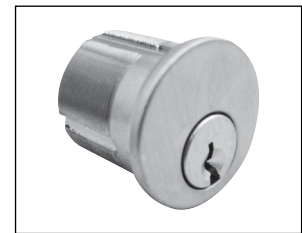

Mortise Cylinder



UL 437 and High Security Cylinders

HIGH SECURITY CYLINDERS AND CORES
SEE HIGH SECURITY CYLINDERS AND CORES SECTION, PAGE 118.

- NOTES:**
- Uncombined cores do not include springs & pins
 - Combined cores include master keying in the list price
 - **PDQ1, PDQ2, PDQ3 (Restricted)**
BEST A2 & A4 Systems Available
 - Control Keys must be ordered separately

Cores and Keyways

DESCRIPTION	PDQ NO.	ADD
SMALL FORMAT UNCOMBINED		
6 Pin Cores	I5206 + KEYWAY	\$40.00
7 Pin Cores	I5207 + KEYWAY	
COMBINATED		
6 Pin Cores	I5206-1 + KEYWAY	\$60.00
7 Pin Cores	I5207-1 + KEYWAY	
BEST Compatible		
A (DEFAULT), B, C, D, E, F, G, H, J, K, L, M, Q,		
WA, WB, WC, WG, WH, TB, TD, TE, & R		
PDQ Exclusive		
PDQ1, PDQ2		
PDQ Exclusive and Restricted		
PDQ3		
SFIC CONSTRUCTION		
Construction Core 6-pin only		\$60.00
Dummy Construction Core Plastic		\$8.00
LFIC CONSTRUCTION		
Construction Core 6-pin only		\$70.00
IC Tailpiece Assembly Construction cores are invoiced at shipment and credited upon return.		
		\$10.00
LFIC COMBINATED		
Schlage compatible LFIC, SCC (Schlage C compatible) keyway		\$70.00
PDQ TA LFIC Restricted		
LFIC UNCOMBINED		
Schlage compatible LFIC, SCC (Schlage C compatible) keyway		\$50.00
HIGH SECURITY IC CORES		
SEE HIGH SECURITY CYLINDERS AND CORES SECTION, PAGE 118. — LFIC REQUIRES LARGE FORMAT LEVER		

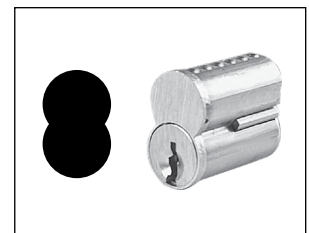

SFL/SFIC Core

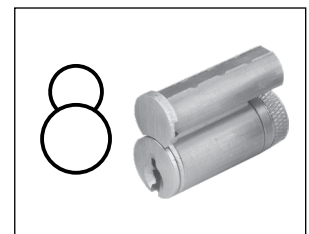

LFL/LFIC Schlage Format







IC Mortise Housing

6300/6400
EXIT DEVICE TRIMS

6300/6400 SERIES TRIMS

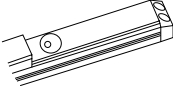
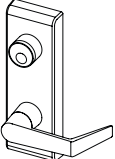
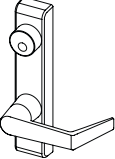
LIST PRICE

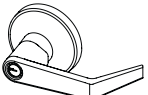
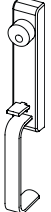
Effective July 3, 2023

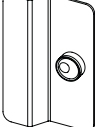
TRIM TYPE	FUNCTION	IMAGE	STANDARD CYLINDER	BEST SFIC	SCHLAGE STYLE LFIC
6C	03 (Less Outside Trim)		Rim cylinder (use rim cylinder included collar, mounting plate & screws)	SFIC Rim Housing (use rim housing included collar, mounting plate & screws)	LFIC Rim Housing (use rim housing included collar, mounting plate & screws)
CYLINDER DOGGING/ALARM KIT	All Devices		1-1/8" Mortise Cylinder 631093 Trim Ring Yale Cam	SFIC 7 pin housing (2) 631093 Trim Rings Yale Cam	LFIC housing 631094 Collar (5/8") Yale Cam
6W	All Keyed Functions		1-1/8" Mortise Cylinder 631094 Collar (5/8") Corbin A01 or Yale Cam	SFIC 7 pin housing 631094 Collar Flipped (3/4") 631093 Trim Ring Corbin A01 or Yale Cam	LFIC housing 631094 Collar Flipped (3/4") 631093 Trim Ring Corbin A01 or Yale Cam
6N	08, 09		1-1/8" Mortise Cylinder 631094 Collar (5/8") Corbin A01 or Yale Cam	SFIC 7 pin housing 631094 Collar Flipped (3/4") 631093 Trim Ring Corbin A01 or Yale Cam	LFIC housing 631094 Collar Flipped (3/4") 631093 Trim Ring Corbin A01 or Yale Cam
6N	03		Rim Cylinder	SFIC rim housing	LFIC rim housing
6S	All Keyed Functions		Must order product with KIK / Standard cylinder lever	Must order product with SFIC lever	Must order product with Schlage style LFIC Lever
6T	All Keyed Functions		1-1/8" Mortise Cylinder 631094 Collar (5/8") Corbin A01 or Yale Cam	SFIC 7 pin housing 631094 Collar Flipped (3/4") 631093 Trim Ring Corbin A01 or Yale Cam	LFIC housing 631094 Collar Flipped (3/4") 631093 Trim Ring Corbin A01 or Yale Cam
6G	All Keyed Functions		Rim Cylinder Standard rim cylinder trim ring	SFIC rim housing Standard rim cylinder trim ring	LFIC rim housing Standard rim cylinder trim ring
6P	All Keyed Functions		Rim Cylinder Standard rim cylinder trim ring	SFIC rim housing Standard rim cylinder trim ring	LFIC rim housing Standard rim cylinder trim ring

6300/6400
EXIT DEVICE TRIMS

Trim Compatibility (Narrow/Medium Stile Aluminum Doors)

Stile	Device Type	Compatible Trims
2 - 1/8" Stile Doors	6400 Narrow Stile Devices	6C Cylinder only: Function (03)
		6C Cylinder with 9E Pull: Function (03) Note: Pull for 6400 CVR Device must be 10"CTC
3 - 1/2" Stile Doors	6400 Narrow Stile Devices	6C Cylinder only: Function (03)
		6C Cylinder with 9E Pull: Function (03) Note: Pull for 6400 CVR Device must offset from device centerline if other than 10"CTC
		6N Escutcheon: Function (01, 02, 03, 08, 09, 14)
		6T Escutcheon: Function (02, 05, 06, 15) Note: This trim does not work on 6400 CVR Device
		6G Pull: Function (02, 03)
3 - 1/2" Stile Doors	6300 Wide Stile Devices	6C Cylinder only: Function (03)
		6C Cylinder with 9E Pull: Function (03)
		6W Escutcheon: Function (02, 08, 09, 14, 99)
		6N Escutcheon: Function (01, 02, 03, 08, 09, 14)
		6T Escutcheon: Function (02, 05, 06, 15)
		6P Pull: Function (03)
		6G Pull: Function (02, 03)

Trim Compatibility (Steel/Wood Doors)

Device Type	Compatible Trims
6400 Narrow Stile Devices	6C Cylinder only: Function (03)
	6C Cylinder with 9E Pull: Function (03)
	6N Escutcheon: Function (01, 02, 03, 08, 09, 14)
	6T Escutcheon: Function (02, 05, 06, 15) Note: This trim does not work on 6400 CVR Device
	6G Pull: Function (02, 03)
6300 Wide Stile Devices	6C Cylinder only: Function (03)
	6C Cylinder with 9E Pull: Function (03)
	6W Escutcheon: Function (02, 08, 09, 14, 99)
	6N Escutcheon: Function (01, 02, 03, 08, 09, 14)
	6T Escutcheon: Function (02, 05, 06, 15)
	6P Pull: Function (03)
	6G Pull: Function (02, 03)

9300 SERIES

Mullions

9300 Mullion

The PDQ 9300 Series removable mullions are designed for use with the 6300/6400 Series Rim Exit Devices on pairs of doors. They are designed for quick removal from the top bracket by simple operation of the rim cylinder when a clear, unobstructed large opening is required. Once the mullion is removed, carts, gurneys, large machinery and the like can freely pass through the opening. When the mullion is re-installed, the unit will self lock in place without a key.

Specifications

Mullion Head/Foot brackets:	• Cast Stainless Steel
Tube Dimensions:	• Powder Coated 2" x 3" Steel - 3/16" Wall
Strike:	• 639080 Strike included for Fire Labeled • Strike not included for panic mullion. Use supplied strike with exit device.
Size:	• 8' or 10' lengths - Can easily be cut to shorter size in field
Finish:	• Powder Coated 689 (Aluminum) • 600 - Primed for Painting
Electrified Options:	• Wire routing w/ plugs
Warranty:	• One (1) year limited warranty
Certifications: Compliances: Listings:	• Fire model is 3 hour fire labeled for pairs up to and including 8' x 8' (With 6300RF/6400RF Rim Device) • Meets requirements of the BAA as a COTS product manufactured in the United States

Orientation

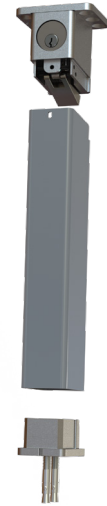
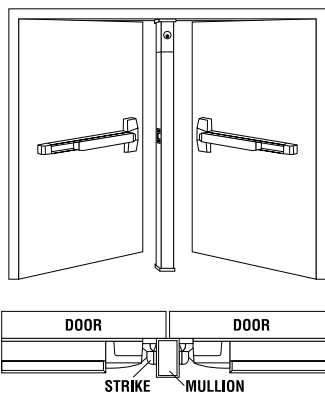

Key Removable

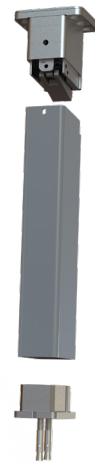

Non-Keyed Removable

How to order

DEVICE TYPE	FOR DOOR HEIGHT	REMOVABLE TYPE	RATING	FINISH	OPTIONS	KEYING
93	0	0	—	689	—	
93 - Mullion	0 - 8' and under Door 1 - 10' and under Door	0 - Key Removable 1 - Non-Keyed Removable	Blank - Non Fire Rated F - Fire Rated (8' Max)	689 - Aluminum 600 - Primer	EM - Electrified Mullion	See Next Page

Mullions - Key Removable

PART	DESCRIPTION	689/600
9300-689	Mullion, 8' non-fire rated and under opening height (can be cut down to non standard opening height)	\$1065.00
9300F-689	Mullion, 8' Listed to UL10C for Fire and under opening height (can be cut down to non standard opening height)	\$1325.00
9310-689	Mullion, 10' and under opening height (can be cut down to non standard opening height)	\$1204.00

Mullions - Hex Key Removable

PART	DESCRIPTION	689/600
9301-689	Mullion, 8' and under opening height (can be cut down to non standard opening height)	\$771.00
9301F-689	Mullion, 8' Listed to UL10C for Fire and under opening height (can be cut down to non standard opening height)	\$1031.00
9311-689	Mullion, 10' and under opening height (can be cut down to non standard opening height)	\$910.00

Electrified Mullion



PART	DESCRIPTION	689/600
9300-689-EM	Mullion, removable by cylinder, 8' and under opening height (can be cut down to non standard opening height), Factory electrified routing prep using Industry standard moxex connectors	\$1348.00
9300F-689-EM	Mullion, Listed to UL10C for Fire, removable by cylinder, 8' and under opening height (can be cut down to non standard opening height), Factory electrified routing prep using Industry standard moxex connectors	\$1608.00
9301-689-EM	Mullion, removable by use of hex key, 8' and under opening height (can be cut down to non standard opening height), Factory electrified routing prep using Industry standard moxex connectors	\$1054.00
9301F-689-EM	Mullion, Listed to UL10C for Fire, removable by use of hex key, 8' and under opening height (can be cut down to non standard opening height), Factory electrified routing prep using Industry standard moxex connectors	\$1314.00
9310-689-EM	Mullion, removable by cylinder, 10' and under opening height (can be cut down to non standard opening height), Factory electrified routing prep using Industry standard moxex connectors	\$1487.00
9311-689-EM	Mullion, removable by use of hex key, 10' and under opening height (can be cut down to non standard opening height), Factory electrified routing prep using Industry standard moxex connectors	\$1193.00

Notes:

- 1. Fire Rated mullion listed only when used with PDQ's 6300/6400 Fire Rated Devices. Use with any other device will void UL Fire Rating.**
- 2. Mullions shipped UPS will be assessed an \$8.00 handling up charge.**

Key Removable Only

CYLINDER TYPE	KEYWAY	KEYING
D	SCC	KD
D Default L Less Cylinder SF6 Lock is SFIC prepped w/ 6 pin core SF7 Lock is SFIC prepped w/ 7 pin core SFL Lock is SFIC prepped but less core SFC Lock is SFIC prepped w/ construction core SFP Lock is SFIC prepped w/ plastic construction core LF6 Lock is Schlage LFIC prepped w/ Schlage core LFL Lock is Schlage LFIC prepped but less core LFC Lock is Schlage LFIC prepped w/ construction core	SCC – Schlage C OTHERS – See Keyway Table Page 176	KD – Keyed Different KA – Keyed Like KO – Zero Bitted MK – Master Keyed CMK – Construction Keyed GMK – Grand Master Keyed

CYLINDER OPTIONS	ICON	LOCK ADJUSTMENT
SFL		N/C
LFL		
D		

IC Core not included.

639081 - Mullion Storage Kit

- Kit includes items necessary to mount/store mullion on the wall when not in use.



Accessories

PART	DESCRIPTION	LIST PRICE
631617	Mullion Fire Strike (Includes fasteners)	\$50.00
639081	Mullion Storage Kit	\$188.00

Note: Strike sold as replacement only. Must provide Order number of previous purchased item.



4200 Series Commercial Wide Stile

Architectural Finishes. No Plastic Parts.

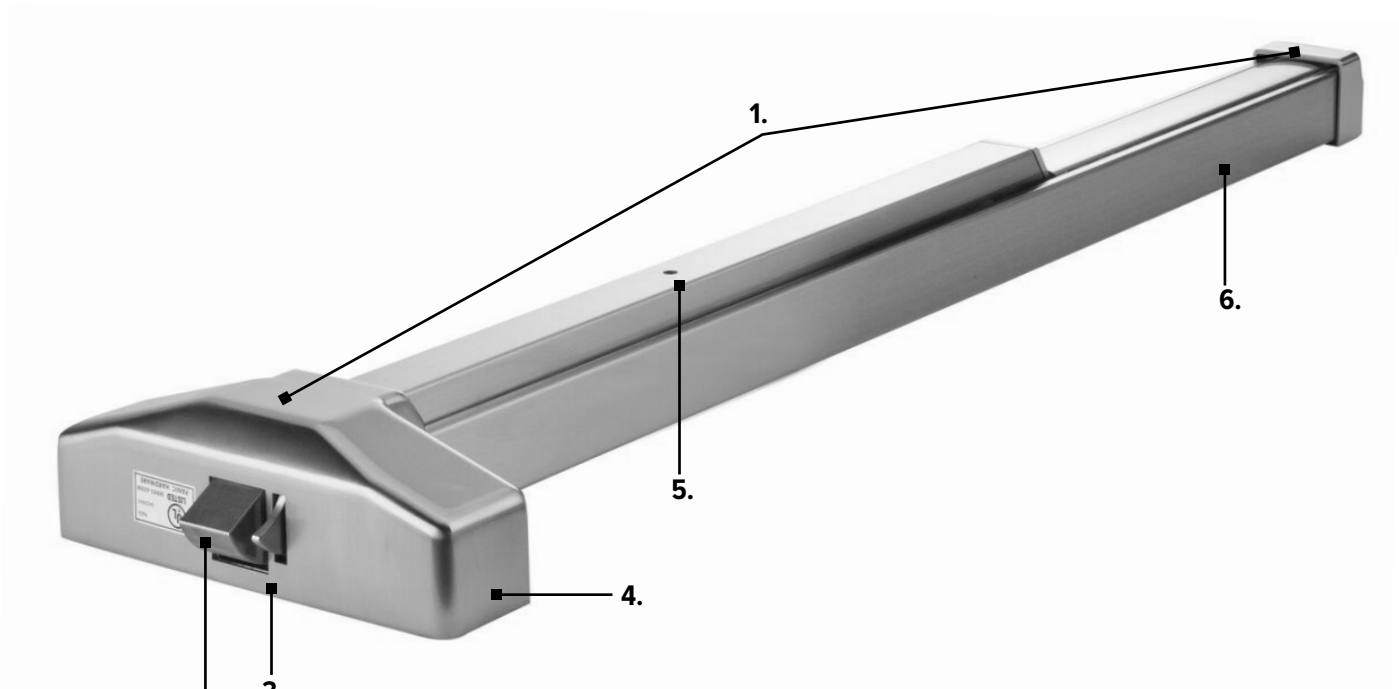

- 1. Metal end caps and chassis cover
- 2. Stainless steel latch bolt with 3/4" throw (rim shown), 5/8" throw (vertical rod devices)
- 3. Deadlocking feature provides tamper resistance (rim shown)
- 4. Corrosion resistant steel plated chassis
- 5. Hex key dogging (Dogging not available with fire labeled devices)
- 6. Heavy gauge roll formed steel or stainless steel rail

Decorative Finish Collection

Architectural

- 605 Bright Brass, Clear Coated
- 626 Satin Chromium Plated
- 630 Satin Stainless Steel

Painted

- 689 Aluminum
- 695 Dark Bronze
- 696 Gold



How to Order

QUANTITY	SERIES	DOGGING	APPLICATION	LABELING	SIZE	FINISH
10	42	00	R	F	A	630
		00 – Hex Key Dogging (Standard) Dogging Not Furnished With Fire Listed Devices	R – Rim V – Surface Vertical Rod	F – Fire Listed, Max. 3' Door Width No Designation – Panic	BLANK – 3' doors (Default) A – Doors up to 4' Consult Door Width Chart to determine correct device for your application	605 – Polished Brass 626 – Satin Chrome 630 – Satin Stainless Steel 689 – Aluminum 695 – Duro Bronze 696 – Gold

Door Width Chart

PART	DESCRIPTION	FOR DOOR	MIN DOOR	MAX CUT	PUSH PAD
4200R	4200 Rim Regular dogging	36"	27"	9"	18"
4200RF	4200 Rim Fire Listed	36"	27"	9"	18"
4200V	4200 SVR Regular dogging	36"	27"	9"	18"
4200VF	4200 SVR Fire Listed	36"	27"	9"	18"
4200RA	4200 Rim Regular dogging	48"	39"	9"	30"
4200VA	4200 SVR Regular dogging	48"	39"	9"	30"

Cross Reference

DESCRIPTION	PDQ	CAL ROYAL	CORBIN/RUSSWIN	DORMA	FALCON	HAGER	PRECISION	SARGENT	S PARKER	TELL	VON DUPRIN	YALE
RIM	4200R	2200	ED8200	8300	19 R	4700 Rim	5100	2828	UL520	8300	22	2100
SURFACE VERTICAL ROD	4200V	2260	ED8400	8400	19 V	4700 SVR	5200	2727	520V	8400	2227	2110

4200R SERIES

Commercial Wide Stile Rim Exit Device



RIM
ANSI TYPE 1



ADA COMPLIANT

Specifications

CHASSIS:	• Corrosion resistant plated steel
RAIL:	• Heavy gauge steel or stainless steel
LATCH:	• RIM (R) – 3/4" throw
BACKSET:	• 2-3/4" Backset Compatible with 161 prep
HAND:	• Device is non-handed
DOGGING:	• Hex key dogging standard • Dogging not available on fire listed devices
MINIMUM STILE WIDTH:	• 4-1/4" for device (exit only) • Minimum stile requirements with trim varies by trim type
DOOR THICKNESS:	• 1-3/4" standard
DOOR WIDTH:	• Standard for 3 ft doors, option available for doors up to 4'
FINISHES:	• 605 – Polished Brass, 626 – Satin Chrome, 630 – Satin Stainless Steel, 689 – Aluminum, 695 – Duro Bronze, 696 – Gold
FASTENERS:	• Includes machine screws and wood screws • Sex nuts supplied with all Fire Listed devices
WARRANTY:	• Five (5) year limited warranty
CERTIFICATIONS, LISTINGS, COMPLIANCES:	• UL 305 listed for "Panic" , UL listed for "Fire Exit Hardware" labeled for up to 1-1/2 hours, 3'0" x 7'0" Max Size • Complies with ADA (Americans with Disabilities Act) and ICC/ANSI 117.1 for Accessible and Usable Buildings • TAA compliant. Country of origin: Taiwan

Rim Exit Device

PART	DESCRIPTION	689/695/696	630	605/626
4200R	Rim, UL panic listed, hex key dogging, 3'0" door	\$282.00	\$442.00	\$382.00
4200RA	Rim, UL panic listed, hex key dogging, 4'0" door	\$324.00	\$484.00	\$424.00
4200RF	Rim, UL fire listed, no dogging, 3'0" door	\$433.00	\$593.00	\$533.00

4200V SERIES

Commercial Wide Stile Surface Vertical Rod Exit Device

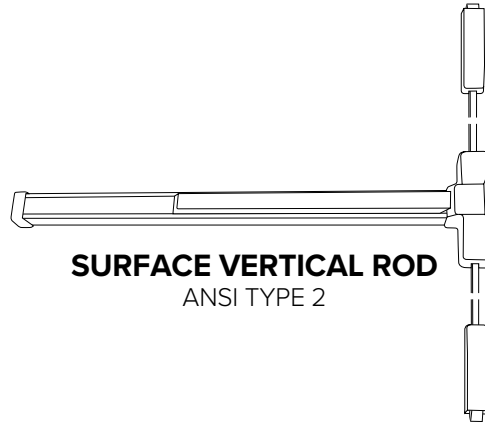

SURFACE VERTICAL ROD
ANSI TYPE 2



Specifications

CHASSIS:	• Corrosion resistant plated steel
RAIL:	• Heavy gauge steel or stainless steel
LATCH:	• SURFACE VERTICAL ROD (V) – Top Latch-Pullman with dead latching 5/8" throw - Bottom Latch- Pullman with 5/8" throw, held retracted during door swing
BACKSET:	• 2-3/4" Backset Compatible with 161 prep
HAND:	• Device is non-handed
DOGGING:	• Hex key dogging standard • Dogging not available on fire listed devices
MINIMUM STILE WIDTH:	• 4-1/4" for device (exit only) • Minimum stile requirements with trim varies by trim type
DOOR THICKNESS:	• 1-3/4" standard
DOOR WIDTH:	• Standard for 3 ft doors, option available for doors up to 4'
FINISHES:	• 605 – Polished Brass, 626 – Satin Chrome, 630 – Satin Stainless Steel, 689 – Aluminum, 695 - Duro Bronze, 696 – Gold
FASTENERS:	• Includes machine screws and wood screws • Sex nuts supplied with all Fire Listed devices
VERTICAL RODS:	• Stock for 7' doors standard. Rod extensions available for doors up to 10'.
WARRANTY:	• Five (5) year limited warranty
CERTIFICATIONS, LISTINGS, COMPLIANCES:	• UL 305 listed for "Panic", UL listed for "Fire Exit Hardware" labeled for pair of doors up to 1-1/2 hours, 6'0" x 7'0" Max Opening • Complies with ADA (Americans with Disabilities Act) and ICC/ANSI 117.1 for Accessible and Usable Buildings • TAA compliant. Country of origin: Taiwan

Surface Vertical Rod Exit Device

PART	DESCRIPTION	689/695/696	630	605/626
4200V	Surface vertical rod, UL panic listed, hex key dogging, 3'0" door	\$539.00	\$699.00	\$639.00
4200VA	Surface vertical rod, UL panic listed, hex key dogging, 4'0" door	\$581.00	\$741.00	\$681.00
4200VF	Surface vertical rod, UL fire listed, no dogging, 3'0" door	\$690.00	\$850.00	\$790.00

4200 SERIES

Commercial Wide Stile Exit Device Trim

Lever Styles



BOSTON — BSN
4SH TRIM ONLY



MIAMI — MIA
4SH TRIM ONLY



PHILADELPHIA — PHL

ALL LEVERS

Trim Types



EW - ESCUTCHEON
WIDE



EN - ESCUTCH-
EON NARROW



GW - GRIP PULL
WIDE



S - SECTIONAL
LEVER



P03 - PULL



P02 - PULL



P01 - PLATE



K - SECTIONAL KNOB

How to Order

QUANTITY	SERIES	TYPE	FUNCTION	LEVER	HANDING	FINISH	DOOR THICKNESS	CYLINDER OR HOUSING	KEYWAY	KEYING
10	4	EW	08	PHL	—	626	—	D	SCC	KD
		K — Knob GW — Grip Pull, Wide Stile P01 — Plate P02 — Pull S — Sectional, Heavy Duty EN* — Escutcheon, Narrow EW* — Escutcheon, Wide	01 — Exit only 02 — Dummy Trim 03 — Night Latch 05 — Classroom w/Thumb Piece 08 — Classroom w/Lever 09 — Storeroom w/Lever 14 — Passage w/Lever 15 — Passage w/Thumb Piece	BSN — Boston MIA — Miami PHL — Philadelphia	RHR LHR	605 — Bright Brass 606 — Satin Brass 613E — Dark Oxidized Satin Bronze 626 — Satin Chrome 630 — Satin Stainless Steel	1- 3/4 - 2"	D Default L Less Cylinder SF6 Lock is SFIC prepped w/ 6 pin core SF7 Lock is SFIC prepped w/ 7 pin core SFL Lock is SFIC prepped but less core SFC Lock is SFIC prepped w/ construction core SFP Lock is SFIC prepped w/ plastic construction core LF6 Lock is Schlage LFIC prepped w/ Schlage core LFL Lock is Schlage LFIC prepped but less core LFC Lock is Schlage LFIC prepped w/ construction core	PAGE 183	
									PAGE 183	

* EN/EW trim available with PHL lever only.





Wide Stile Trim

STYLE		FUNCTION	DESCRIPTION	TRIM TYPE	605	613E	626	689/695	
4EW		02	Dummy Trim (Rigid Lever)	4 EW 02 PHL	\$304.00		\$289.00	-	
		08	Classroom w/ Lever	4 EW 08 PHL	\$317.00		\$302.00		
		09	Storeroom w/ Lever	4 EW 09 PHL					
		14	Passage w/ Lever	4 EW 14 PHL	\$304.00		\$289.00		
4EN		02	Dummy Trim (Rigid Lever)	4 EN 02 PHL	\$164.00	-	\$149.00	\$134.00	
		08	Classroom w/ Lever	4 EN 08 PHL	\$182.00			\$167.00	\$152.00
		09	Storeroom w/ Lever	4 EN 09PHL					
		14	Passage w/ Lever	4 EN 14 PHL	\$164.00			\$149.00	\$134.00

STYLE		FUNCTION	DESCRIPTION	TRIM TYPE	605/606/613E	626	689/695
4S	 <p>Sectional lever trim not compatible when using SNB to through bolt device chassis</p>	02	Dummy Trim (Rigid Lever)	4 S 02 BSN, MIA, PHL	\$150.00	\$135.00	-
		08	Classroom w/ Lever	4 S 08 BSN, MIA, PHL	\$204.00	\$189.00	
		09	Storeroom w/Lever	4 S 09 BSN, MIA, PHL			
		14	Passage w/ Lever	4 S 14 BSN, MIA, PHL	\$150.00	\$135.00	

Note: For functions and finishes not shown, contact PDQ Customer Service.



CYLINDER OPTIONS	ICON	LOCK ADJUSTMENT
SFL		N/C
LFL		

IC Core not included see page 192 for core options.

Wide Stile Trim

STYLE	FUNCTION	DESCRIPTION	TRIM TYPE	605	613E	626	630	689/695	
4K 	08	Classroom	4 K 08		-		\$74.00	-	
	14	Passage	4 K 14						
4P 	01	Exit Only	4 P 01	-		-	\$36.00		
	02	Dummy Pull Trim	4 P 02						
	03	Night Latch	4 P 03						
4GW 	02	Dummy Trim (Grip Pull only)	4 GW 02	\$184.00	-		-	\$154.00	
	03	Night Latch	4 GW 03						
	05	Classroom w/Thumb Piece	4 GW 05						\$214.00
	15	Passage w/Thumb Piece	4 GW 15						\$184.00

* Specify handing. For functions and finishes not shown, contact PDQ Customer Service.

CYLINDER OPTIONS	ICON	LOCK ADJUSTMENT
SFL		N/C
LFL		

IC Core not included see page 183 for core options

Accessories

PART (SPECIFY FUNCTION)	DESCRIPTION	LIST PRICE PLATED (605/626/630)	LIST PRICE PAINTED (689/695/696)
429020	Top surface vertical rod for 7'0" door	\$56.00	\$44.00
429021	1' extension, vertical rod (specify finish)*		
429023	3' extension, vertical rod (specify finish)*		
429024	Bottom surface vertical rod (specify finish)*		
429001	Sex nut and bolt set	\$33.00	\$21.00
429002	Plate, Latch Filler-covers Type 160 or 161 prep	\$10.00	N/A
429003	Plate, Strike filler		
429005	Strike, SVR Top, Fire and Panic w/2 ea. 1/16" shims	\$17.00	
429006	Strike, SVR Bottom, Fire and Panic w/2 ea. 1/16" shims		
429036	Strike, Rim, Fire and Panic		
429019	Double door strike	\$33.00	
429014	Trim back plate (2-1/2" x 8"), use w/narrow escutcheon to cover 161 prep	\$21.00	
429017	Trim back plate (3-1/2" x 8"), use w/narrow escutcheon to cover 161 prep	\$42.00	
429018	Adapter plate	\$10.00	
429150	Universal Glass Bead Kit - Includes 2 ea. 1/8" spacers for chassis, end cap and rod guides.	\$79.00	
429043	Dogging Key	\$8.00	

*Not for Fire Rated Devices

4200 SERIES

LIST PRICE

Effective July 3, 2023

Keyways and Cylinders

PDQ KEYWAY	COMPATIBLE WITH	SOLD WITH LOCK
AR1	Arrow / AR1	N/C
CO59A1	Corbin / 59A1	
CO6	Corbin / 60	
CL4	Corbin / L4	
RUD	Russwin / D1	
SCE	Schlage / E	
SCC	Schlage / C	
SCC-K	Schlage / C-K	
SAL	Sargent / LA	
RA-RC	Sargent / RA-RC	
YA8	Yale / E1R	
GA	Yale / GA	
FAL	Falcon / E-R	
KW	Kwikset	
TA	PDQ / TA (Restricted. Limited to Grandmaster systems w/4 masters)	
Dummy	—	
T-Turn	—	
L	Less Cylinder	
HIGH SECURITY CYLINDERS AND CORES		
SEE HIGH SECURITY CYLINDERS AND CORES SECTION, PAGE 118.		

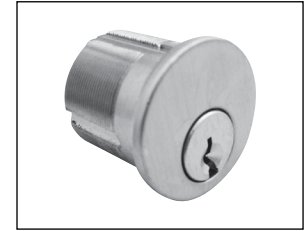

Mortise Cylinder



UL 437 and High Security Cylinders

NOTES:

- Uncombined cores do not include springs & pins
- Combined cores include master keying in the list price
- **PDQ1, PDQ2, PDQ3 (Restricted)**
BEST A2 & A4 Systems Available
- Control Keys must be ordered separately

Cores and Keyways

DESCRIPTION	PDQ NO.	ADD
SMALL FORMAT UNCOMBINATED		
6 Pin Cores	I5206 + KEYWAY	\$40.00
7 Pin Cores	I5207 + KEYWAY	
COMBINATED		
6 Pin Cores	I5206-1 + KEYWAY	\$60.00
7 Pin Cores	I5207-1 + KEYWAY	
BEST™ Compatible		
A (DEFAULT), B, C, D, E, F, G, H, J, K, L, M, Q, WA, WB, WC, WG, WH, TB, TD, TE, & R		
PDQ Exclusive		
PDQ1, PDQ2		
PDQ Exclusive and Restricted		
PDQ3		
SFIC CONSTRUCTION		
Construction Core 6-pin only		\$60.00
Dummy Construction Core Plastic		\$8.00
LFIC CONSTRUCTION		
Construction Core 6-pin only		\$70.00
IC Tailpiece Assembly Construction cores are invoiced at shipment and credited upon return.		\$10.00
LFIC COMBINATED		
Schlage compatible LFIC, SCC (Schlage C compatible) keyway		\$70.00
PDQ TA LFIC Restricted		
LFIC UNCOMBINATED		
Schlage compatible LFIC, SCC (Schlage C compatible) keyway		\$50.00
HIGH SECURITY IC CORES		
SEE HIGH SECURITY CYLINDERS AND CORES SECTION, PAGE 118. — LFIC REQUIRES LARGE FORMAT LEVER		

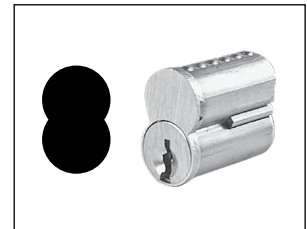

SFL/SFIC Core

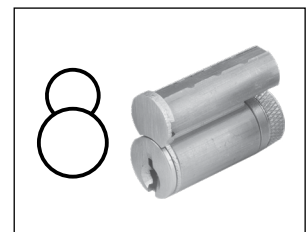

LFL/LFIC Schlage Format



IC Mortise Housing

4200 SERIES
EXIT DEVICE TRIMS



ANSI Trim Functions

ANSI FUNCTION	DESCRIPTION
01	Exit only, no trim or blank escutcheon.
02	Entrance by trim when actuating bar is locked down (dummy trim).
03	Entrance by trim when latch is released by key. Key removable only when locked (night latch).
05	Entrance by thumb piece. Key locks or unlocks thumb piece (classroom thumb piece).
08	Entrance by knob or lever. Key locks or unlocks knob or lever (classroom knob/lever).
09	Entrance by knob or lever only when released by key. Key removable when locked.
14	Entrance by trim when latch bolt is released by knob or lever. Always active, no cylinder (passage knob/lever).
15	Entrance by trim when latchbolt is released by thumb piece. Always active, no cylinder (passage thumb piece).

*All functions not available in every trim style

Finishes

CODE	TYPE	DESCRIPTION
605 (US3)	Architectural	Bright Brass, Clear Coated
613E	Architectural	Dark Oxidized Satin Bronze, No Coating
626 (US26D)	Architectural	Satin Chromium Plated, No Coating
630 (US32D)	Architectural	Satin Stainless Steel, No Coating
689 (US28)	Color	Aluminum

*All finishes not available in every trim style

Handing

Out Swing Door

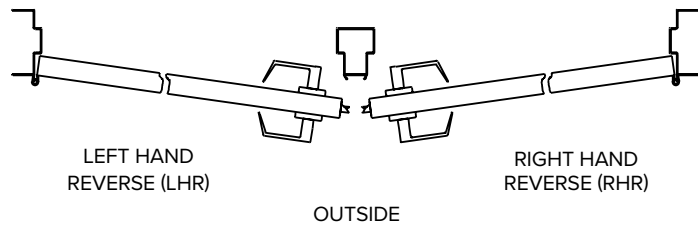

Default Trim Cylinder Reference Guide

ANSI FUNCTION	DESCRIPTION	EW ESCUTCHEON WIDE	EN ESCUTCHEON NARROW	S SECTIONAL LEVER	P PLATE	GW GRIP PULL, WIDE STILE	K SECTIONAL KNOB
03	Night Latch	—	—	—	RIM	RIM	—
05	Classroom w/Thumb Piece	—	—	—	—	Mortise	—
08	Classroom w/Lever	Mortise	Mortise	Key in Knob/Lever	—	—	Key in Knob/Lever
09	Storeroom w/Lever	Mortise	—	Key in Knob/Lever	—	—	—

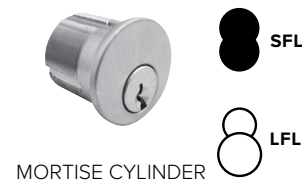
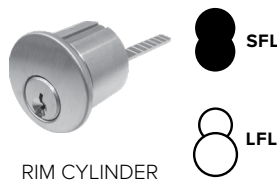
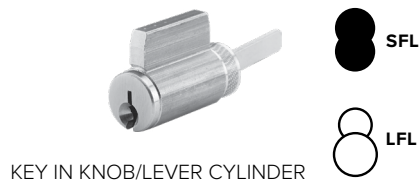

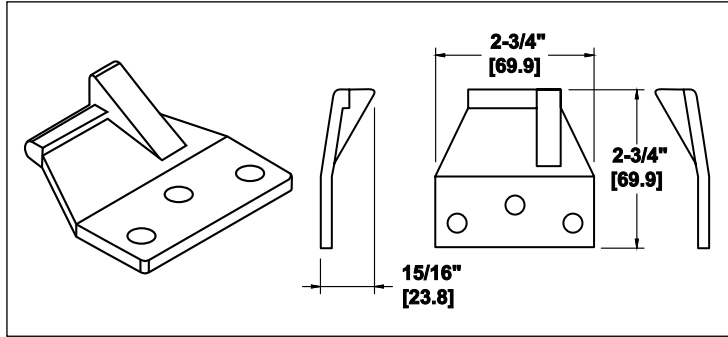

429019 DOUBLE DOOR STRIKE

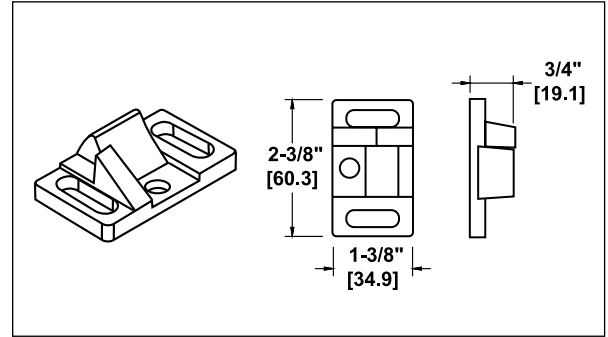

429005 SVR TOP STRIKE W/2 SHIMS PANIC AND FIRE

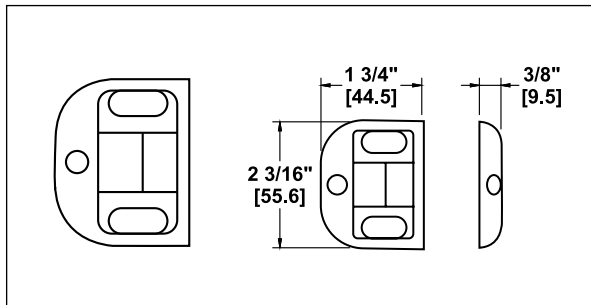

429006 SVR BOTTOM STRIKE
W/2 SHIMS PANIC AND FIRE

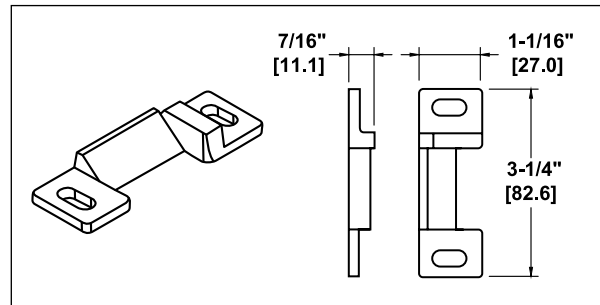

429036 RIM STD.
(2-3/4" BACKSET) FIRE & PANIC

Making Door Control Easy

PDQ offers a comprehensive line of door closers designed and manufactured to ensure superior performance and reliability. They offer the perfect combination of reliability, appearance, and durability. With a wide range of models and features, PDQ has a door closer for most applications.

Comprehensive Offering

7100 Institutional



Applications

7100 — The 7100 Series is PDQ's top of line heavy duty closer. It is designed for high use, high abuse institutional applications such as K-12, higher education and government buildings. 7100 Series closers are ideal for retrofit and new construction applications where strength and durability are required.

5100 Institutional



Applications

5100 — **5100** Series Door Closer is a heavy duty multi-feature closer that is perfect for high use, high abuse applications such as K-12, higher education, and government buildings. The 5100's compact design is ideal for interior door applications where it's distinctive lines harmonize with most decors.

5500 Commercial



Applications

5500 (Full cover) — Designed for maximum versatility, the 5500 Series sports a full cover and can be used for both commercial and institutional applications. This rugged workhorse is perfect for high traffic applications including federal/state buildings, assisted living facilities, hospitality, retail, religious, and medical buildings.

5300 Commercial



Applications

5300 (Slim cover) — The aesthetically pleasing 5300 Series comes standard with a slim line cover and offers the ideal combination of appearance, reliability, and durability for today's market. This rugged closer is perfect for high traffic applications such as healthcare, hospitality, government, assisted living, retail, and religious facilities.

3100 Light Commercial



Applications

3100 — Designed for medium-light duty applications, the 3100 Series is ideal for aluminum storefronts, interior offices, multi family, hospitality and many other applications. The 3100 combines dependable operation, low maintenance and stylish look.

7100 SERIES

Grade 1 Heavy Duty Closer

Typical Applications

- Assisted Living
- Higher Education
- High Use/High Abuse Situations
- K-12 Education
- Military and Government
- Multi-family
- Offices
- Public Buildings

Features

- Features a 1-1/2" (38mm) diameter hardened steel pinion
- Heavy duty, fully featured architectural style door control
- High strength cast iron body and forged steel arm assembly provide maximum durability and reliability in the most brutal environments
- Backcheck positioning valve feature provides a consistent backcheck snubbing range for regular, top jamb and parallel arm applications, preventing costly damage during forceful opening of the door

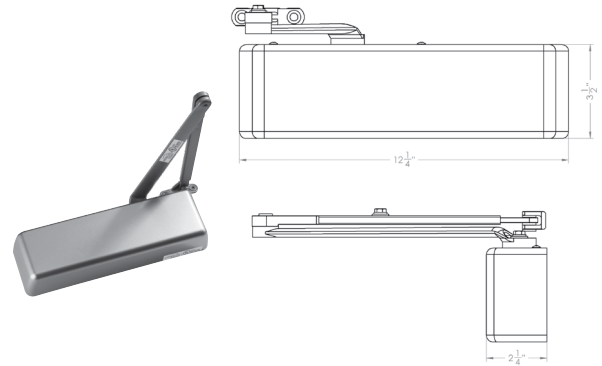

Specifications



BODY:	• High Strength Cast Iron
ARMS:	• Forged steel main arm
ARM OPTIONS:	<ul style="list-style-type: none"> • PA – Parallel Arm • HO – Hold Open • DS/DSHO – Heavy Duty Parallel Stop • RA – Regular Arm • SCS/SCSHO – Spring Cushion Stop for DS/DSHO • TA/TAHO – Track Arm • EDA/EDAHO – Extra Duty Parallel Arm
PISTON:	• 1-1/2" diameter
ADJUSTMENT:	<ul style="list-style-type: none"> • Hydraulic controlled closing • Hydraulic backcheck standard • Backcheck positioning valve standard (starts backcheck snubbing sooner) • Optional delayed action (in addition to backcheck)
ADJUSTMENT VALVES:	• All Adjustment Valves are STAKED to prevent removal during adjustment.
SIZE:	• Adjustable BF through 6
MOUNTING RETROFIT:	<ul style="list-style-type: none"> • Mounting hole pattern retrofits LCN™ 4040 • Tri-packed for regular, top jamb and parallel arm installations • Includes sex nuts/bolts and screws for wood/metal doors/frames • Self drilling self tapping screws standard • Separate limiting stop may be required for high abuse applications
COVER:	• Full plastic cover standard, optional full metal cover available
COLOR & ARCHITECTURAL FINISHES:	• 605 – Polished Brass, 625 – Polished Chrome, 689 – Aluminum, 693 – Black, 695 – Duro Bronze, 696 – Gold
WARRANTY:	• Twenty-five (25) year Limited Warranty
CERTIFICATIONS, LISTINGS, COMPLIANCES:	<ul style="list-style-type: none"> • UL listed for labeled swinging fire doors rated up to and including 3 hours • Certified to ANSI/BHMA A156.4 Grade 1 • Complies with ADA (Americans with Disabilities Act) and ICC/ANSI 117.1 for Accessible and Usable Buildings • TAA compliant. Country of origin: KR

Spring Cushion Stops



**605
BRIGHT
BRASS**



**613E DARK OX-
IDIZED SATIN
BRONZE**



**630 SATIN
STAINLESS
STEEL**



693 BLACK

PDQ's SCS Series Spring Cushion Stop helps reduce wear and tear on the opening. As the door begins moving through back check to its maximum opening angle, the stop acts as a shock absorber, dampening the impact forces



7100 SERIES

LIST PRICE

Effective July 3, 2023

How to Order

QUANTITY	SERIES	DELAYED ACTION	BACKCHECK	ARM TYPE	FINISH	ACCESSORIES
10	71	01 – Non-Delayed Action 41 – Delayed Action (In Addition To Backcheck)	BC – Adjustable Hydraulic Backcheck	PA DS – Door Saver Arm DSHO – Door Saver Hold Open Arm EDA – Extra Duty Arm EDAHO – Extra Duty Arm Hold Open HO – Hold Open, Tri-Pack PA – Tri-Pack (standard) RA – Regular Arm SCS – Spring Cushion Stop SCSHO – Spring Cushion Stop Hold open TA – Track Arm TAHO – Track Arm Hold Open BLANK – Body Only	689 605 – Polished Brass 625 – Polished Chrome 689 – Aluminum 693 – Black 695 – Duro Bronze 696 – Gold	— BP – Back Plate BS – Blade Stop Spacer DPPA – Parallel Arm Drop Plate DPTJ – Top Jamb Drop Plate FCM – Full Metal Cover specify hand NFB – Narrow Frame Bracket SDST – Self Drilling Self Tapping Screws

PAGE 189

Closers

PART	SIZE	DESCRIPTION	PAINTED 689/693 695/696	PLATED 605/625
7101 BC PA	BF-6	Closer, full cover, SNB (Tri-pack)	\$342.00	\$497.00
7101 BC RA	BF-6	Closer, full cover, Regular Arm, SNB		
7101 BC PA HO	BF-6	Closer, hold open, full cover, SNB (Tri-pack)	\$425.00	\$580.00
7101 BC DS	BF-6	Closer, door saver, full cover, SNB (PA Only)	\$450.00	\$605.00
7101 BC DSHO	BF-6	Closer, door saver hold open, full cover, SNB (PA Only)	\$475.00	\$630.00
7101 BC EDA	BF-6	Closer, extra duty arm, full cover, SNB (PA Only)	\$450.00	\$605.00
7101 BC EDA HO	BF-6	Closer, extra duty arm hold open, full cover, SNB (PA Only)	\$475.00	\$630.00
7101 BC SCS	BF-6	Closer, door saver w/spring cushion stop, full cover, SNB (PA Only)	\$542.00	\$697.00
7101 BC SCSHO	BF-6	Closer, door saver hold open w/spring cushion stop, full cover, SNB (PA Only)	\$558.00	\$713.00
7101 BC TA	BF-6	Closer, track arm, full cover, (SNB for closer body only)	\$424.00	—
7101 BC TA HO	BF-6	Closer, track arm hold open, full cover (SNB for closer body only)	\$445.00	
7101 BC	BF-6	Closer, body only	\$262.00	

Options

PART NO.	DESCRIPTION	CLOSER ADJUSTMENT
7141	Delayed Action (when ordering, replace 7101 with 7141 in part number)	\$28.00

Accessories

CODE	DESCRIPTION	LIST PRICE	
		PAINTED 689/693/695/696	PLATED 605/625
BS	Blade Stop Spacer (no finish)	\$80.00	-
BP	Back Plate		-
DPPA	Parallel Arm Drop Plate (PA mount)		-
DPTJ	Top Jamb Drop Plate (TJ mount)		-
BPTJ	Top Jamb Back Plate - Required to mount TJ on frame face less than 4"		-
FCM	Full Metal Cover (specify hand)	\$120.00	\$170.00
NFB	Narrow Frame Bracket for DS/DSHO/EDS/EDAHO Arms, PA & BS Brackets	\$48.00	-
SDST	Self Drilling Self Tapping Screws	\$17.00	\$35.00

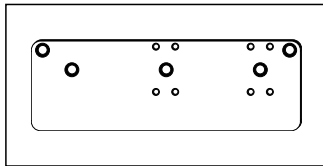

BP - BACK PLATE

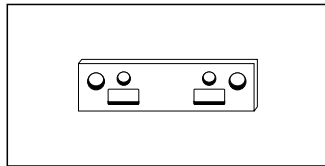

BS - BLADE STOP SPACER

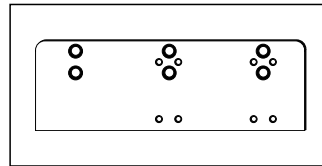

DPTJ - TOP JAMB DROP PLATE

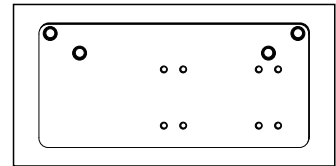

DPPA - PARALLEL ARM DROP PLATE

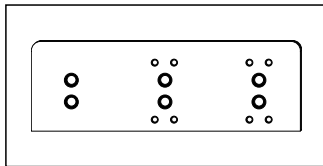

BPTJ - TOP JAMB BACK PLATE

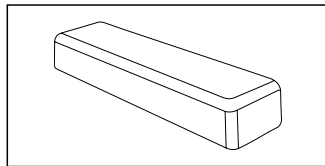

FCM - FULL METAL COVER

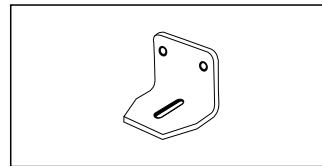

NFB - NARROW FRAME BRACKET

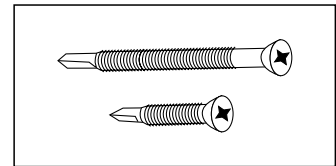

SDST - SELF DRILLING SELF TAPPING SCREWS

Arms

CODE	DESCRIPTION	PART NO. (SPECIFY FINISH)	LIST PRICE	
			PAINTED 689/693/695/696	PLATED 605/625
RA	REGULAR ARM - Can be mounted REG/TJ/PA (requires PA bracket)	719003	\$96.00	\$171.00
EDA	EXTRA DUTY ARM - PA application only (bumper eliminated)	719005	\$145.00	\$220.00
DS	DOOR SAVER ARM (Limiting Stop) - PA application only	719005		
DSHO	DOOR SAVER HOLD OPEN ARM (limiting stop) PA application only	719016	\$165.00	\$240.00
HO	HOLD OPEN ARM - can be mounted REG/TJ/PA (requires PA bracket)	719002	\$122.00	\$197.00
EDAHO	EXTRA DUTY ARM HOLD OPEN - PA application only (bumper eliminated)	719016	\$165.00	\$240.00
TA	TRACK ARM ASSEMBLY - (Includes track, arm and screws)	719025	\$122.00	-
TAHO	TRACK ARM HOLD OPEN	719027	\$140.00	-
PA	PARALLEL ARM BRACKET - HO and NHO	719001	\$22.00	\$97.00
ELR	Extended arm half to be used on Top Jamb mounts with reveals from 3" to 6"	719028	\$55.00	-

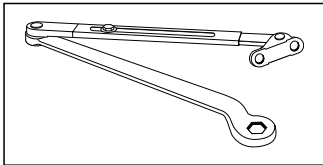

RA - REGULAR ARM

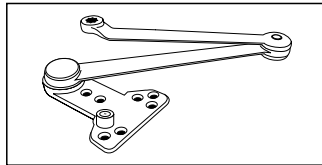

DS - Door Saver (Limiting Stop) Arm

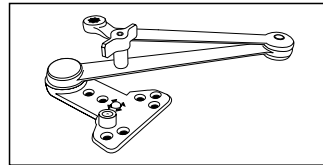

DSHO - DOOR SAVER (LIMITING STOP) HOLD OPEN ARM

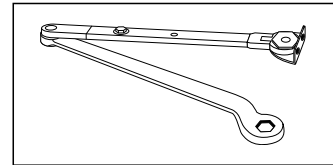

HO - Hold Open Arm

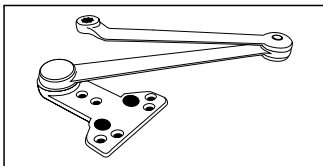

EDA - EXTRA DUTY ARM

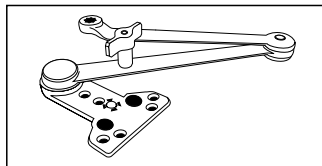

EDAHO - EXTRA DUTY ARM HOLD OPEN

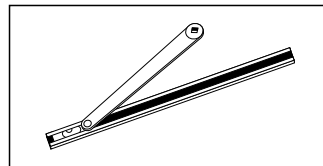

TA - TRACK ARM ASSEMBLY

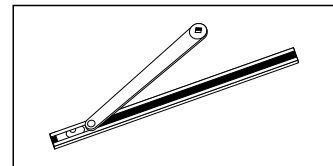

TAHO - TRACK ARM HOLD OPEN

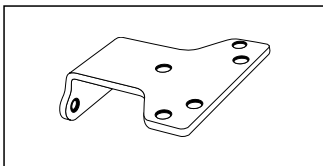

PA - PARALLEL ARM BRACKET

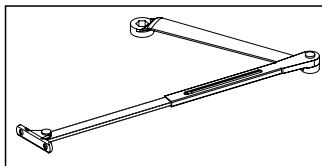

ELR - EXTENDED ARM

Covers

CODE	DESCRIPTION	PART NO. (SPECIFY FINISH)	LIST PRICE	
			PAINTED 689/693/695/696	PLATED 605/625
FC	FULL PLASTIC COVER	719006	\$45.00	\$90.00
FCM	FULL METAL COVER - Optional (specify hand)	719006ST	\$120.00	\$170.00

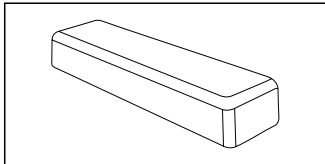

FC - FULL PLASTIC COVER

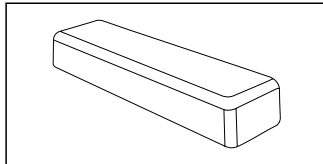

FCM - FULL METAL COVER

Mounting Plates

CODE	DESCRIPTION	PART NO. (SPECIFY FINISH)	LIST PRICE
			PAINTED 689/693/695/696
BP	BACK PLATE - For regular arm applications to clear mortised stop/holder	719008	\$80.00
BPTJ	TOP JAMB BACK PLATE - Required to mount TJ on frame face less than 4"	719024	
DPTJ	TOP JAMB DROP PLATE - Required to mount TJ with limited ceiling clearance or to clear surface applied stop/holder	719023	
DPPA	PARALLEL ARM DROP PLATE - Required for parallel arm mount with limited top door rail	719018	
BS*	BLADE STOP SPACER - Shims all PA brackets to clear 1/2" blade stop (no finish)	999026	
NFB	NARROW FRAME BRACKET - For DS/DSHO/EDS/EDAHO arms, PA and BS brackets for added reinforcement (no finish)	999011	\$48.00

*Note: When using a Blade Stop Spacer in a narrow frame application you must use the (NFB) Narrow Frame Bracket for proper support.

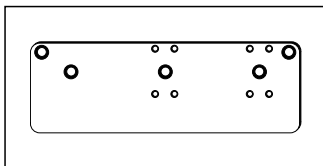

BP - BACK PLATE

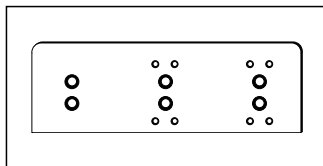

BPTJ - TOP JAMB BACK PLATE

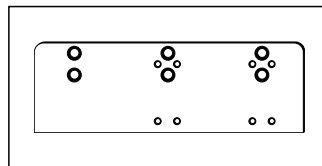

DPTJ - TOP JAMB DROP PLATE

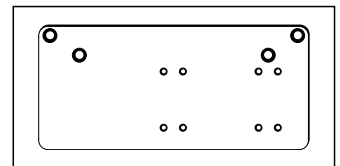

DPPA - PARALLEL ARM DROP PLATE

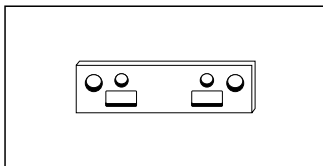

BS - BLADE STOP SPACER

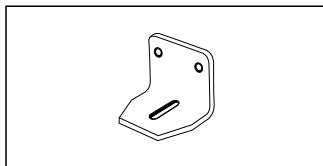

NFB - NARROW FRAME BRACKET

7100 SERIES

LIST PRICE

Effective July 3, 2023

Fasteners

CODE	DESCRIPTION	PART NO. (SPECIFY FINISH)	LIST PRICE	
			PAINTED 689/693/695/696	PLATED 605/625
SDST	SELF DRILLING SELF TAPPING SCREWS	719007	\$17.00	\$35.00
SP	SCREW PACK	999004		
SNB	SEX NUTS AND BOLTS -For through bolting on unreinforced hollow core, composite or labeled fire doors 1-3/4" only. (set of 4 each)	719020		
TSP	Tamper resistant screw pack	*719042	\$90.00	

*No finish

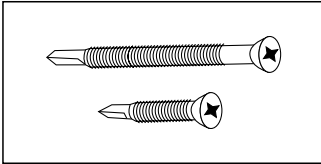

SDST - SELF DRILLING SELF TAPPING SCREWS

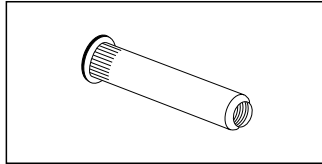

SNB - SEX NUTS AND BOLTS

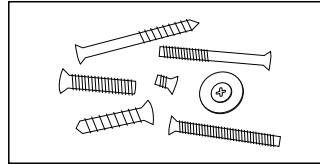

SP - SCREW PACK

Parts

CODE	DESCRIPTION	PART NO. (SPECIFY FINISH)	LIST PRICE	
			PAINTED 689/693 695/696	PLATED 605/625
DSBS	DOOR SAVER BUMPER STOP - (no finish) Used on DS, DSHO, PS arms	999010	\$22.00	
SPBL	PLASTIC SPACER BLOCK - For DS/DSHO/EDA/EDAHO and PA soffit brackets (no finish)	999031	\$10.00	
HO KIT	TA ARM TO MAKE TAHO (no finish)	999030	\$35.00	
SCS	SPRING CUSHION STOP* - USE with DS/DSHO for 3'0" doors (specify finish), for PA mount arms only	999032	\$150.00	
SCS	SPRING CUSHION STOP* - For DS/DSHO for 4'0" doors, (specify finish), for PA mount arms only	999033		

* Spring Cushion Stop requires purchase of a PDQ DS or DSHO arm.

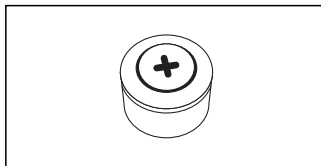

DSBS - DOOR SAVER BUMPER STOP

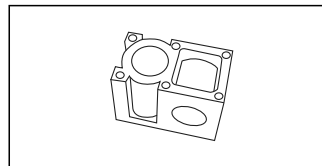

SPBL - PLASTIC SPACER BLOCK

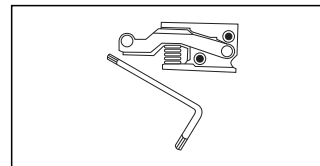

HO KIT - TA ARM TO MAKE TAHO

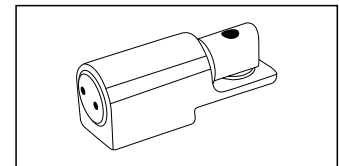

SCS - SPRING CUSHION STOP

Spring Cushion Stop (SCS) Finish Match to Closers

SCS FINISH	CLOSER FINISH
605 (PVD)	605/696
613E (PVD)	695
630	625/626/689
693	693

5100 SERIES

Grade 1 Institutional Closer

Typical Applications

- Aluminum Storefronts
- Assisted Living
- Government Facilities
- Higher Education
- Hospitality
- Houses of Worship
- Interior Office Doors
- Multi-family
- Offices
- Retail

Features

- Features a 1-1/2" (38 mm) diameter hardened steel pinion
- Fully featured architectural style door control
- Full cover and flat design arm assembly provide both durability and aesthetically pleasing appearance in commercial and institutional applications
- The closer is ideally suited for installation on wood or metal doors and frames.
- The units are non-handed and fully adjustable from size one through six for maximum flexibility.
- The standard tri-pack feature provides versatility to permit regular, top-jamb and parallel arm installations.
- A range of sprayed and architectural finishes are available to compliment any décor.
- Maximum 4" reveal for Top Jamb.

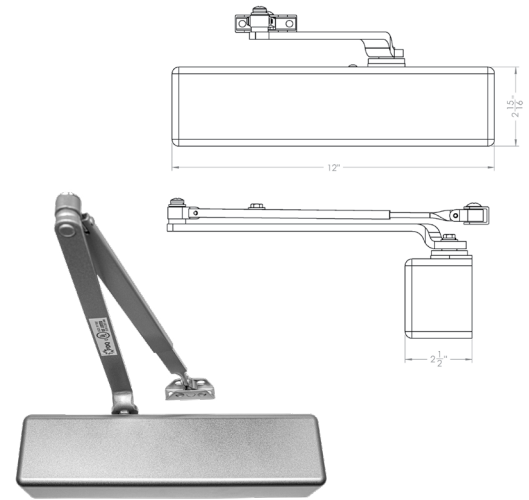

Specifications



BODY:	• High Strength Aluminum Alloy Body
ARM OPTIONS:	<ul style="list-style-type: none"> • PA – Parallel Arm • HO – Hold Open • DS/DSHO – Heavy Duty Parallel Arm Stop • RA – Regular Arm • SCS/SCSHO – Heavy Duty Parallel Arm Cushion Stop • TA/TAHO – Track Arm • EDA/EDAHO – Extra Duty Parallel Arm • PS – Pivot Stop Arm*
PINION:	• Hardened steel, 1-1/2" diameter
ADJUSTMENT:	• Hydraulic controlled closing • Separate hydraulic backcheck standard • Optional delayed action (in addition to backcheck)
SIZE:	• Adjustable 1 through 6
MOUNTING:	<ul style="list-style-type: none"> • Tri-packed for regular, top jamb and parallel arm installations • Includes sex nuts/bolts and screws for wood/metal doors/frames • Self drilling, self tapping screws standard • Separate limiting stop may be required for high abuse application
COVER:	• Full plastic cover standard, optional full metal cover available
COLOR & ARCHITECTURAL FINISHES:	• 605 – Polished Brass, 626 – Satin Chrome, 689 – Aluminum, 693 – Black, 695 – Duro Bronze, 696 – Gold
WARRANTY:	• Twenty-five (25) year Limited Warranty
CERTIFICATIONS, LISTINGS, COMPLIANCES:	<ul style="list-style-type: none"> • UL listed for labeled swinging fire doors rated up to and including 3 hours • Certified to ANSI/BHMA A156.4 Grade 1 • TAA compliant. Country of origin: KR

5100 SERIES

LIST PRICE

Effective July 3, 2023

How to Order

5100 SERIES
DOOR CLOSERS

QUANTITY	SERIES	DELAYED ACTION	BACKCHECK	ARM TYPE	FINISH	ACCESSORIES
10	51	01	BC	PA	689	—
NOTES 1 - Hold Open (HO) option not permitted for use on labeled fire doors. 2 - Separate limiting stop may be required.		01 – Non-Delayed Action 41 – Delayed Action (In Addition To Backcheck)	BC – Adjustable Hydraulic Backcheck	DS – Door Saver Arm DSHO – Door Saver Hold Open Arm EDA – Extra Duty Arm EDA HO – Extra Duty Arm Hold Open HO – Hold Open, Tri-Pack PA – Tri-Pack (standard) RA – Regular Arm SCS – Spring Cushion Stop SCSHO – Spring Cushion Stop Hold open TA – Track Arm TAHO – Track Arm Hold Open PS – Pivot Stop Arm BLANK – Body Only	605 – Polished Brass 626 – Satin Chrome 689 – Aluminum 693 – Black 695 – Duro Bronze 696 – Gold	BP – Back Plate BS – Blade Stop Spacer DPPA – Parallel Arm Drop Plate DPTJ – Top Jamb Drop Plate FCM – Full Metal Cover specify hand NFB – Narrow Frame Bracket SDST – Self Drilling Self Tapping Screws

PAGE 195

Closers

PART	DESCRIPTION	PAINTED 689/693 695/696	PLATED 605/626
5101 BC PA	Closer, 1-6, full cover, SNB (Tri-pack)	\$262.00	\$362.00
5101 BC RA	Closer, 1-6, full cover, regular arm, SNB		
5101 BC PA HO	Closer, 1-6, hold open, full cover, SNB (Tri-pack)	\$342.00	\$442.00
5101 BC DS	Closer, 1-6, door saver, full cover, SNB (PA only)	\$367.00	\$467.00
5101 BC DSHO	Closer, 1-6, door saver hold open, full cover, SNB (PA only)	\$397.00	\$497.00
5101 BC EDA	Closer, 1-6, extra duty arm, full cover, SNB (PA only)	\$367.00	\$467.00
5101 BC EDA HO	Closer, 1-6, extra duty arm hold open, full cover, SNB (PA only)	\$397.00	\$497.00
5101 BC SCS	Closer, 1-6, door saver w/spring cushion stop, full cover, SNB (PA only)	\$462.00	\$562.00
5101 BC SCSHO	Closer, 1-6, door saver hold open w/spring cushion stop, full cover, SNB (PA only)	\$467.00	\$567.00
5101 BC TA	Closer, 1-6, track arm, full cover (SNB for closer body only)	\$317.00	-
5101 BC TAHO	Closer, 1-6, track arm hold open, full cover (SNB for closer body only)	\$342.00	-
5101 BC PS	Closer, 1-6, pivot stop, full cover (SNB for closer body only)	\$412.00	-
5101 BC	Closer, 1-6, body only	\$200.00	-

Options

PART NO.	DESCRIPTION	CLOSER ADJUSTMENT
5141	Delayed Action (when ordering, replace 5101 with 5141 in part number)	\$28.00

Accessories

CODE	DESCRIPTION	LIST PRICE	
		PAINTED 689/693/695/696	PLATED 605/625
BS	Blade Stop Spacer (no finish)	\$80.00	-
BP	Back Plate		
DPPA	Parallel Arm Drop Plate (5500 only)		
DPTJ	Top Jamb Drop Plate		
NFB	Parallel Arm NHO Bracket	\$48.00	
SDST	Self Drilling Self Tapping Screws	\$17.00	\$35.00

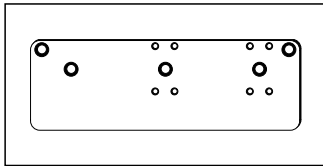

BP - BACK PLATE

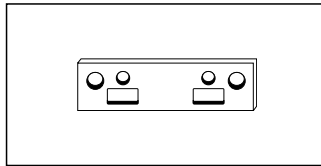

BS - BLADE STOP SPACER

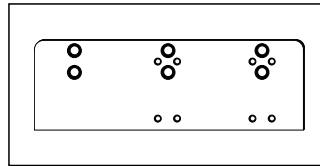

DPTJ - TOP JAMB DROP PLATE

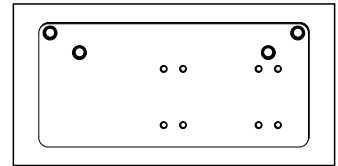

DPPA - PARALLEL ARM DROP PLATE

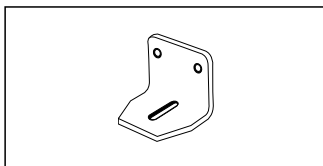

NFB - NARROW FRAME BRACKET

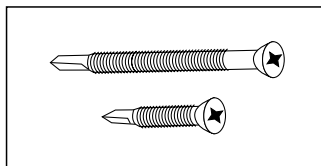

SDST - SELF DRILLING SELF TAPPING SCREWS

Spring Cushion Stops



605
BRIGHT
BRASS



613E DARK OX-
IDIZED SATIN
BRONZE



630 SATIN
STAINLESS
STEEL



693 BLACK

PDQ's SCS Series Spring Cushion Stop helps reduce wear and tear on the opening. As the door begins moving through back check to its maximum opening angle, the stop acts as a shock absorber, dampening the impact forces

Arms

CODE	DESCRIPTION	PART NO. (SPECIFY FINISH)	LIST PRICE	
			PAINTED 689/693/695/696	PLATED 605/625
RA	REGULAR ARM - Can be mounted REG/TJ/PA (requires PA bracket)	999003	\$80.00	\$130.00
EDA	EXTRA DUTY ARM - PA application only (bumper eliminated)	999005	\$160.00	\$210.00
DS	DOOR SAVER ARM (Limiting Stop) - PA application only	999005		
DSHO	DOOR SAVER HOLD OPEN ARM (limiting stop) PA application only	999016	\$194.00	\$244.00
HO	HOLD OPEN ARM - can be mounted REG/TJ/PA (requires PA bracket)	999002	\$122.00	\$172.00
EDAHO	EXTRA DUTY ARM HOLD OPEN - PA application only (bumper eliminated)	999016	\$194.00	\$244.00
TA	TRACK ARM ASSEMBLY - (Includes track, arm and screws)	999025	\$122.00	
TAHO	TRACK ARM HOLD OPEN	999027	\$145.00	
PA	PARALLEL ARM BRACKET - NON HOLD OPEN applications	999001	\$22.00	\$72.00
PAHO	PARALLEL ARM BRACKET - HOLD OPEN applications	999022	\$33.00	
PS	PIVOT STOP ARM - Regular and Top Jamb Only	999018	\$184.00	

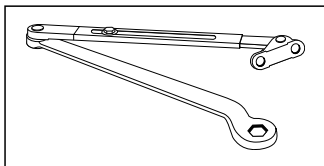

RA - REGULAR ARM

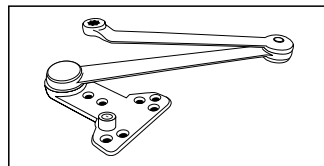

DS - DOOR SAVER (LIMITING STOP) ARM

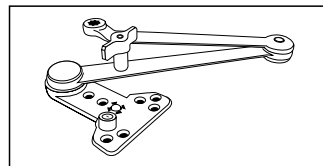

DSHO - DOOR SAVER (LIMITING STOP) HOLD OPEN ARM

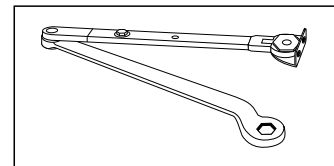

HO - HOLD OPEN ARM

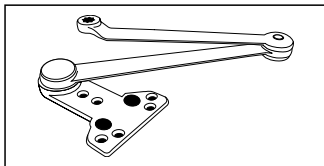

EDA - EXTRA DUTY ARM

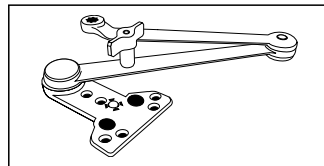

EDAHO - EXTRA DUTY ARM HOLD OPEN

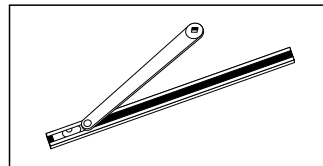

TA - TRACK ARM ASSEMBLY

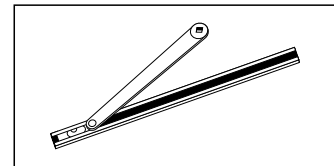

TAHO - TRACK ARM HOLD OPEN

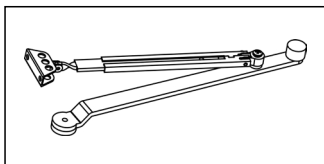

PS - PIVOT STOP ARM

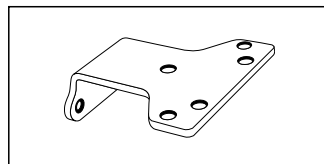

PA - PARALLEL ARM BRACKET

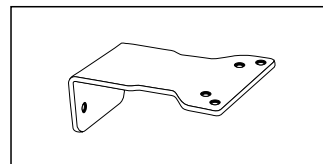

PAHO - PARALLEL ARM HO BRACKET

Covers

CODE	DESCRIPTION	PART NO. (SPECIFY FINISH)	LIST PRICE	
			PAINTED 689/693/695/696	PLATED 605/625
FC	FULL PLASTIC COVER	559006	\$45.00	\$90.00
FMC	FULL METAL COVER	519006ST	\$100.00	-

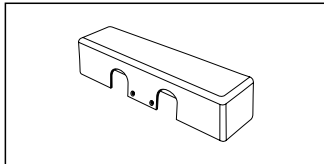

FC - FULL PLASTIC COVER-5500
(STANDARD)

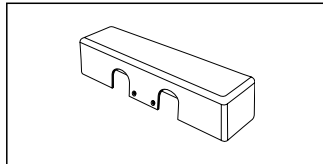

FMC - FULL METAL COVER
(OPTIONAL)

Mounting Plates

CODE	DESCRIPTION	PART NO. (SPECIFY FINISH)	LIST PRICE
			PAINTED 689/693/695/696
BP	BACK PLATE - For regular arm applications to clear mortised stop/holder	519008	\$80.00
DPTJ	TOP JAMB DROP PLATE - Required to mount TJ with limited ceiling clearance or to clear surface applied stop/holder	519023	
DPPA	PARALLEL ARM DROP PLATE - Required for parallel arm mount with limited top door rail	519018	
BS*	BLADE STOP SPACER - Shims all PA brackets to clear 1/2" blade stop (no finish)	999026	
NFB	NARROW FRAME BRACKET - For DS/DSHO/EDS/EDAHO arms, PA and BS brackets for added reinforcement (no finish)	999011	\$48.00

*Note: When using a Blade Stop Spacer in a narrow frame application you must use the (NFB) Narrow Frame Bracket for proper support.

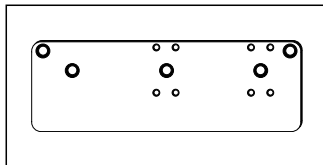

BP - BACK PLATE

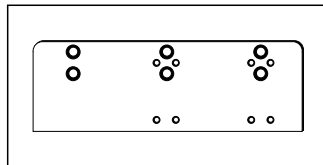

DPTJ - TOP JAMB DROP PLATE

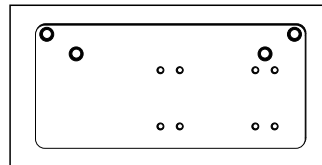

DPPA - PARALLEL ARM DROP
PLATE

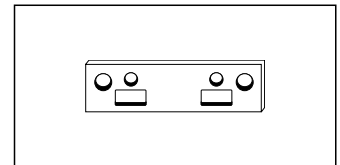

BS - BLADE STOP SPACER

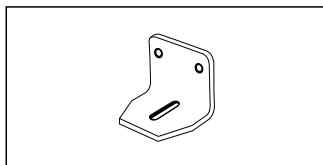

NFB - NARROW FRAME BRACKET

5100 SERIES

LIST PRICE

Effective July 3, 2023

5100 SERIES
DOOR CLOSERS

Fasteners

CODE	DESCRIPTION	PART NO. (SPECIFY FINISH)	LIST PRICE	
			PAINTED 689/693/695/696	PLATED 605/625
SDST	SELF DRILLING SELF TAPPING SCREWS	999007	\$17.00	\$35.00
SP	SCREW PACK	999020		
SNB	SEX NUTS AND BOLTS -For through bolting on unreinforced hollow core, composite or labeled fire doors 1-3/4" only. (set of 4 each)	999004		

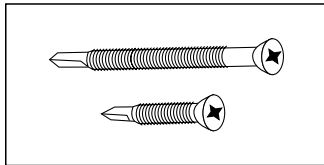

SDST - SELF DRILLING SELF TAPPING SCREWS

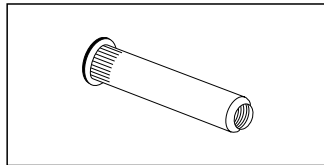

SNB - SEX NUTS AND BOLTS

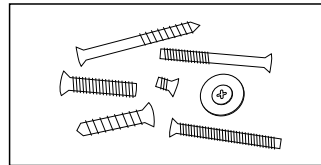

SP - SCREW PACK

Parts

CODE	DESCRIPTION	PART NO. (SPECIFY FINISH)	LIST PRICE	
			PAINTED 689/693 695/696	PLATED 605/625
DSBS	DOOR SAVER BUMPER STOP - (no finish) Used on DS, DSHO, PS Arms	999010	\$22.00	
SPBL	PLASTIC SPACER BLOCK - For DS/DSHO/EDA/EDAHO and PA soffit brackets (no finish)	999031	\$10.00	
HO KIT	TA ARM TO MAKE TAHO (no finish)	999030	\$35.00	
SCS	SPRING CUSHION STOP* - USE with DS/DSHO for 3'0" doors (specify finish), for PA mount arms only	999032	\$150.00	
SCS	SPRING CUSHION STOP* - For DS/DSHO for 4'0" doors, (specify finish), for PA mount arms only	999033		

* Spring Cushion Stop requires purchase of a PDQ DS or DSHO arm.

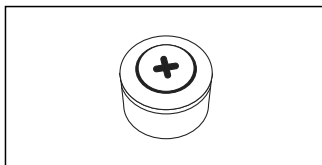

DSBS - DOOR SAVER BUMPER STOP

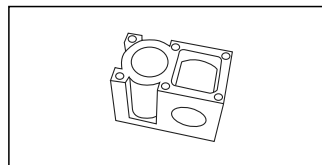

SPBL - PLASTIC SPACER BLOCK

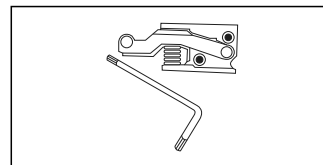

HO KIT - TA ARM TO MAKE TAHO

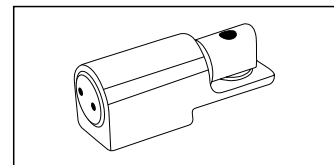

SCS - SPRING CUSHION STOP

Spring Cushion Stop (SCS) Finish Match to Closers

SCS FINISH	CLOSER FINISH
605 (PVD)	605/696
613E (PVD)	695
630	625/626/689
693	693

5300 Slim Cover 5500 Full Cover SERIES

Grade 1 Commercial Closer

Typical Applications

- Assisted Living
- Exterior Doors in Heavy Draft/Wind Conditions
- Government Facilities
- Healthcare
- Higher Education
- Hospitality
- Houses of Worship
- Industrial
- K-12 Education
- Offices
- Retail

Features

- Heavy duty, fully featured architectural style door control
- Available with modern streamline cover or full sized cover
- Compact appearance and features meet the demands of institutional and commercial applications
- The standard tri-pack, full range spring adjustment and common 12" x 3/4" mounting hole pattern make the 5300/5500 ideally suited for stocking distributors and retrofit applications
- Adjustable hydraulic backcheck prevents damage for uncontrolled door opening
- Perfect solution for a variety of applications requiring streamline architectural grade door controls
- Maximum 4" reveal for Top Jamb.

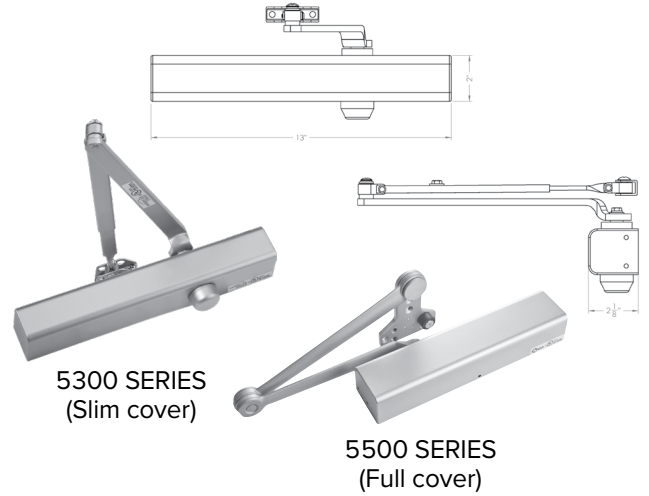

5300 SERIES
(Slim cover)

5500 SERIES
(Full cover)

Specifications



BODY:	• Cast High Strength Aluminum Alloy Body
ARM OPTIONS:	<ul style="list-style-type: none"> • PA – Parallel Arm • HO – Hold Open • DS/DSHO – Heavy Duty Parallel Arm Stop • RA – Regular Arm • SCS/SCSHO – Heavy Duty Parallel Arm Cushion Stop • TA/TAHO – Track Arm • EDA/EDAHO – Extra Duty Parallel Arm • PS – Pivot Stop Arm*
ADJUSTMENT:	<ul style="list-style-type: none"> • Hydraulic controlled closing • Separate hydraulic backcheck standard • Optional adjustable delayed action (in addition to backcheck)
RETROFIT:	• Common 12" x 3/4" mounting hole pattern retrofits Norton 8300/8500* and Yale 3300/3500
SIZE:	• Adjustable • BF through 6
MOUNTING:	<ul style="list-style-type: none"> • Includes sex nuts/bolts and screws for wood/metal doors/frames • Tri-packed for regular, top jamb and parallel arm installations • Separate limiting stop may be required for high abuse applications • Self drilling, self tapping screws standard
COVER:	• 5300 Series - Streamline plastic cover (non-handed) 5500 Series - Full plastic cover standard (field reversible)
COLOR & ARCHITECTURAL FINISHES:	• 605 – Polished Brass, 625 – Polished Chrome, 689 – Aluminum, 693 – Black, 695 – Duro Bronze, 696 – Gold
WARRANTY:	• Twenty-five (25) year Limited Warranty
CERTIFICATIONS, LISTINGS, COMPLIANCES:	<ul style="list-style-type: none"> • UL listed for labeled swinging fire doors rated up to and including 3 hours • Certified to ANSI/BHMA A156.4 Grade 1 • Complies with ADA (Americans with Disabilities Act) and ICC/ANSI 117.1 for Accessible and Usable Buildings • TAA compliant. Country of origin: KR

5300/5500 SERIES

LIST PRICE

Effective July 3, 2023

How to Order

QUANTITY	SERIES	DELAYED ACTION	BACKCHECK	ARM TYPE	FINISH	ACCESSORIES
10	53	01	BC	PA	689	—
	53 – Slim Cover 55 – Full Cover	01 – Non-Delayed Action 41 – Delayed Action (In Addition to Backcheck)	BC – Adjustable Hydraulic Backcheck	DS – Door Saver Arm DSHO – Door Saver Hold Open Arm EDA – Extra Duty Arm EDAHO – Extra Duty Arm Hold Open HO – Hold Open, Tri-Pack PA – Tri-Pack (standard) RA – Regular Arm SCS – Spring Cushion Stop SCSHO – Spring Cushion Stop Hold open TA – Track Arm TAHO – Track Arm Hold Open PS – Pivot Stop Arm BLANK – Body Only	605 – Polished Brass 625 – Polished Chrome 689 – Aluminum 693 – Black 695 – Duro Bronze 696 – Gold	BP – Back Plate BS – Blade Stop Spacer DPPA – Parallel Arm Drop Plate DPTJ – Top Jamb Drop Plate NFB – Narrow Frame Bracket
						PAGE 202

5300/5500 SERIES DOOR CLOSERS

5300/5500 SERIES

LIST PRICE

Effective July 3, 2023

Closers

PART	DESCRIPTION	PAINTED 689/693 695/696	PLATED 605/625
5300 SERIES			
5301 BC PA	Closer, BF-6, streamline cover, SNB (Tri-pack)	\$240.00	\$340.00
5301 BC RA	Closer, BF-6, regular arm, streamline cover, SNB		
5301 BC PA HO	Closer, BF-6, hold open, streamline cover, SNB (Tri-pack)	\$320.00	\$420.00
5301 BC DS	Closer, BF-6, door saver, streamline cover, SNB (PA only)	\$345.00	\$445.00
5301 BC DSHO	Closer, BF-6, door saver hold open, streamline cover, SNB (PA only)	\$375.00	\$475.00
5301 BC EDA	Closer, BF-6, extra duty arm, streamline cover, SNB (PA only)	\$345.00	\$445.00
5301 BC EDAHO	Closer, BF-6, extra duty hold open, streamline cover, SNB (PA only)	\$375.00	\$475.00
5301 BC SCS	Closer, BF-6, door saver w/spring cushion stop, streamline cover, SNB (PA only)	\$440.00	\$540.00
5301 BC SCSHO	Closer, BF-6, door saver hold open w/spring cushion stop, streamline cover, SNB (PA only)	\$445.00	\$545.00
5301 BC TA	Closer, BF-6, track arm, streamline cover (SNB for closer body only)	\$295.00	
5301 BC TAHO	Closer, BF-6, track arm hold open, streamline cover (SNB for closer body only)	\$320.00	
5301 BC PS	Closer, BF-6, pivot stop, streamline cover (SNB for closer body only)	\$390.00	
5301 BC	Closer, BF-6, body only	\$200.00	
5500 SERIES			
5501 BC PA	Closer, BF-6, full cover, SNB (Tri-pack)	\$240.00	\$340.00
5501 BC RA	Closer, BF-6, regular arm, streamline cover, SNB		
5501 BC PA HO	Closer, BF-6, hold open, full cover, SNB (Tri-pack)	\$320.00	\$420.00
5501 BC DS	Closer, BF-6, door saver, full cover, SNB (PA only)	\$345.00	\$445.00
5501 BC DSHO	Closer, BF-6, door saver hold open, full cover, SNB (PA only)	\$375.00	\$475.00
5501 BC EDA	Closer, BF-6, extra duty arm, full cover, SNB (PA only)	\$345.00	\$445.00
5501 BC EDAHO	Closer, BF-6, extra duty arm hold open, full cover, SNB (PA only)	\$375.00	\$475.00
5501 BC SCS	Closer, BF-6, door saver w/spring cushion stop, full cover, SNB (PA only)	\$440.00	\$540.00
5501 BC SCSHO	Closer, BF-6, door saver hold open w/spring cushion stop, full cover, SNB (PA only)	\$445.00	\$545.00
5501 BC TA	Closer, BF-6, track arm, streamline cover (SNB for closer body only)	\$295.00	
5501 BC TAHO	Closer, BF-6, rack arm hold open, streamline cover (SNB for closer body only)	\$320.00	
5501 BC PS	Closer, BF-6, pivot stop, full cover (SNB for closer body only)	\$390.00	
5501 BC	Closer, BF-6, body only	\$200.00	

5300/5500
SERIES
DOOR CLOSERS

Options

CODE	DESCRIPTION	CLOSER ADJUSTMENT
5341	Delayed Action 5300 Series (when ordering, replace 5301 with 5341 in part number)	\$28.00
5541	Delayed Action 5500 Series (when ordering, replace 5501 with 5541 in part number)	

Accessories

CODE	DESCRIPTION	LIST PRICE	
		PAINTED 689/693/695/696	PLATED 605/625
BS	Blade Stop Spacer (no finish)	\$80.00	-
BP	Back Plate		-
DPPA	Parallel Arm Drop Plate (5500 only)		-
DPTJ	Top Jamb Drop Plate (and PA Drop for 5300 only)		-
NFB	Parallel Arm NHO Bracket	\$48.00	-
SDST	Self Drilling Self Tapping Screws	\$17.00	\$35.00

5300/5500 SERIES DOOR CLOSERS

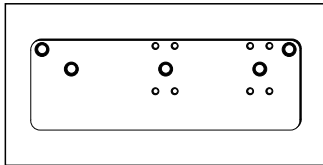

BP - BACK PLATE

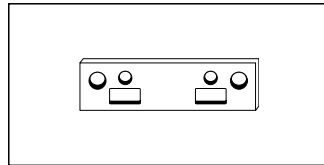

BS - BLADE STOP SPACER

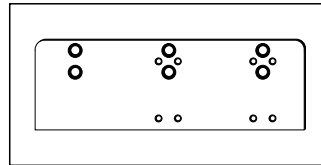

DPTJ - TOP JAMB DROP PLATE

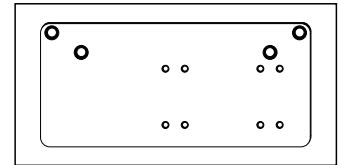

DPPA - PARALLEL ARM DROP PLATE

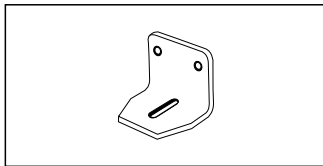

NFB - NARROW FRAME BRACKET

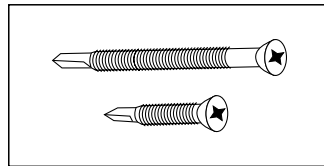

SDST - SELF DRILLING SELF TAPPING SCREWS

Spring Cushion Stops



605 BRIGHT BRASS



613E DARK OXIDIZED SATIN BRONZE



630 SATIN STAINLESS STEEL



693 BLACK

PDQ's SCS Series Spring Cushion Stop helps reduce wear and tear on the opening. As the door begins moving through back check to its maximum opening angle, the stop acts as a shock absorber, dampening the impact forces — See page 223

Arms

CODE	DESCRIPTION	PART NO. (SPECIFY FINISH)	LIST PRICE	
			PAINTED 689/693/695/696	PLATED 605/625
RA	REGULAR ARM - Can be mounted REG/TJ/PA (requires PA bracket)	999003	\$80.00	\$130.00
EDA	EXTRA DUTY ARM - PA application only (bumper eliminated)	999005	\$160.00	\$210.00
DS	DOOR SAVER ARM (Limiting Stop) - PA application only	999005		
DSHO	DOOR SAVER HOLD OPEN ARM (limiting stop) PA application only	999016	\$194.00	\$244.00
EDAHO	EXTRA DUTY ARM HOLD OPEN - PA application only (bumper eliminated)	999016	\$122.00	\$172.00
HO	HOLD OPEN ARM - can be mounted REG/TJ/PA (requires PA bracket)	999002	\$194.00	\$244.00
TA	TRACK ARM ASSEMBLY - (Includes track, arm and screws)	999025	\$122.00	
TAHO	TRACK ARM HOLD OPEN	999027	\$145.00	
PA	PARALLEL ARM BRACKET - NON HOLD OPEN applications	999001	\$22.00	\$72.00
PAHO	PARALLEL ARM BRACKET- HOLD OPEN applications	999022	\$33.00	
PS	PIVOT STOP ARM - Regular and Top Jamb Only	999018	\$184.00	

5300/5500
SERIES
DOOR CLOSERS

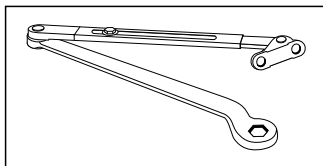

RA - REGULAR ARM

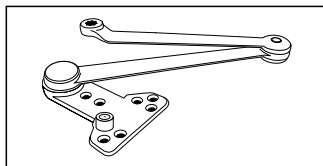

DS - DOOR SAVER (LIMITING STOP) ARM

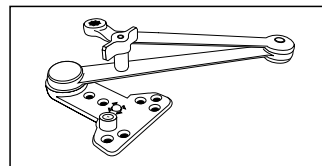

DSHO - DOOR SAVER (LIMITING STOP) HOLD OPEN ARM

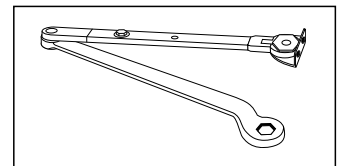

HO - HOLD OPEN ARM

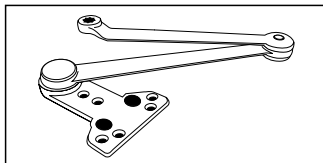

EDA - EXTRA DUTY ARM

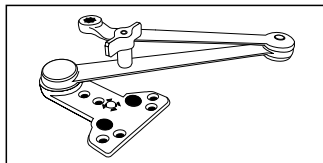

EDAHO - EXTRA DUTY ARM HOLD OPEN

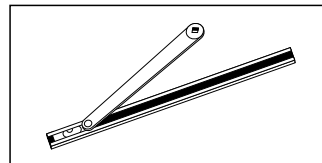

TA - TRACK ARM ASSEMBLY

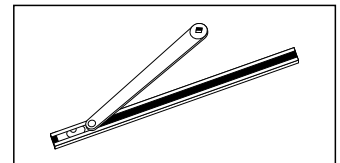

TAHO - TRACK ARM HOLD OPEN

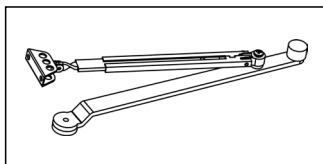

PS - PIVOT STOP ARM

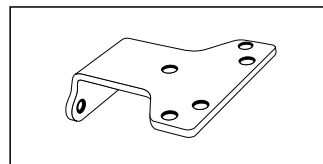

PA - PARALLEL ARM BRACKET

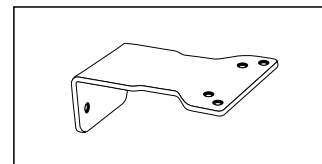

PAHO - PARALLEL ARM HO BRACKET

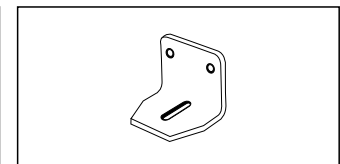

NFB - NARROW FRAME BRACKET

Covers

CODE	DESCRIPTION	PART NO. (SPECIFY FINISH)	LIST PRICE	
			PAINTED 689/693/695/696	PLATED 605/625
FC	5500 SERIES FULL PLASTIC COVER (field reversible)	559006	\$45.00	\$90.00
SV	5300 SERIES STREAMLINE PLASTIC COVER (non-handed)	539006		

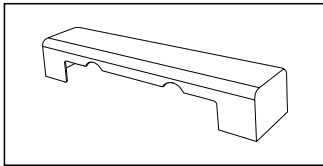

FC - FULL PLASTIC COVER (5500)

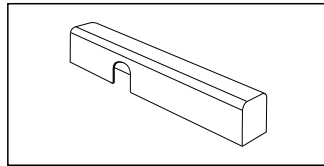

SV - STREAMLINE PLASTIC COVER (5300)

Mounting Plates

CODE	DESCRIPTION	PART NO. (SPECIFY FINISH)	LIST PRICE
			PAINTED 689/693/695/696
BP	BACK PLATE - For regular arm applications to clear mortised stop/holder	539008/559008	\$80.00
DPTJ	TOP JAMB DROP PLATE - Required to mount TJ with limited ceiling clearance or to clear surface applied stop/holder	999023	
DPPA	PARALLEL ARM DROP PLATE - Required for parallel arm mount with limited top door rail	559018	
BS*	BLADE STOP SPACER - Shims all PA brackets to clear 1/2" blade stop (no finish)	999026	
NFB	NARROW FRAME BRACKET - For DS/DSHO/EDS/EDAHO arms, PA and BS brackets for added reinforcement (no finish)	999011	\$48.00

*Note: When using a Blade Stop Spacer in a narrow frame application you must use the (NFB) Narrow Frame Bracket for proper support.

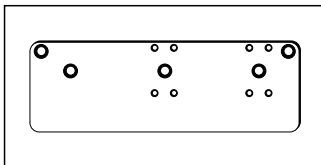

BP - BACK PLATE
(539008/559008)

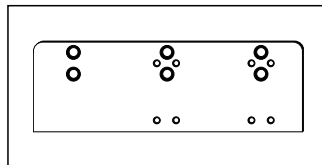

DPTJ - TOP JAMB DROP PLATE

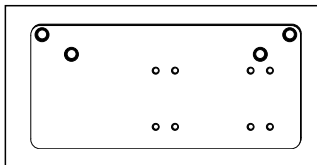

DPPA - PARALLEL ARM DROP PLATE

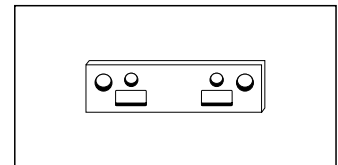

BS - BLADE STOP SPACER

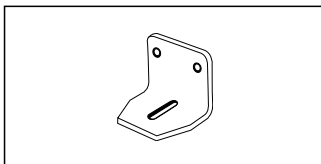

NFB - NARROW FRAME BRACKET

Fasteners

CODE	DESCRIPTION	PART NO. (SPECIFY FINISH)	LIST PRICE	
			PAINTED 689/693/695/696	PLATED 605/625
SDST	SELF DRILLING SELF TAPPING SCREWS	999007	\$17.00	\$35.00
SP	SCREW PACK	999020		
SNB	SEX NUTS AND BOLTS -For through bolting on unreinforced hollow core, composite or labeled fire doors 1-3/4" only. (set of 4 each)	999004		

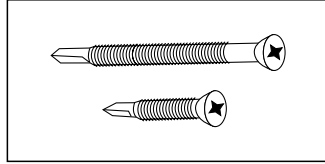

SDST - SELF DRILLING SELF TAPPING SCREWS

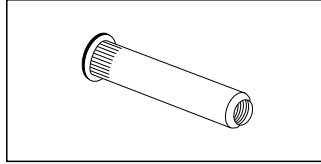

SNB - SEX NUTS AND BOLTS

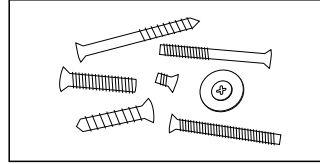

SP - SCREW PACK

5300/5500 SERIES DOOR CLOSERS

Parts

CODE	DESCRIPTION	PART NO. (SPECIFY FINISH)	LIST PRICE	
			PAINTED 689/693 695/696	PLATED 605/625
DSBS	DOOR SAVER BUMPER STOP - (no finish) Used on DS, DSHO, PS arms	999010	\$22.00	-
SPBL	PLASTIC SPACER BLOCK - For DS/DSHO/EDA/EDAHO and PA soffit brackets (no finish)	999031	\$10.00	
HO KIT	TA ARM TO MAKE TAHO (no finish)	999030	\$35.00	
SCS	SPRING CUSHION STOP* - USE with DS/DSHO for 3'0" doors (specify finish), for PA mount arms only	999032	\$150.00	
SCS	SPRING CUSHION STOP* - For DS/DSHO for 4'0" doors, (specify finish), for PA mount arms only	999033		

* Spring Cushion Stop Function requires purchase of a PDQ DS or DSHO arm.

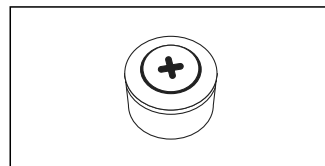

DSBS - DOOR SAVER BUMPER STOP

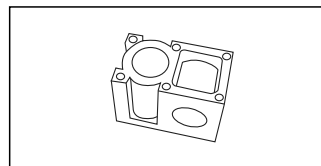

SPBL - PLASTIC SPACER BLOCK

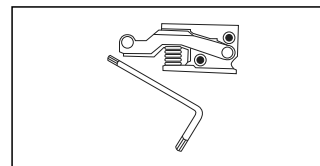

HO KIT - TA ARM TO MAKE TAHO

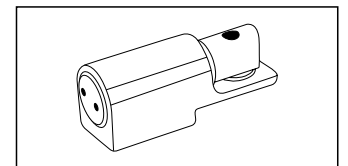

SCS - SPRING CUSHION STOP

SCS FINISH	CLOSER FINISH
605 (PVD)	605/696
613E (PVD)	695
630	625/626/689
693	693

3100 SERIES

Grade 1 Light Commercial Closer

Typical Applications

- Aluminum Storefronts
- Assisted Living
- Hospitality
- Interior Offices
- Multi-family

Features

- Traditional door style door control for use in commercial door applications
- Fasteners are provided to facilitate installation on wood, hollow metal and aluminum doors and frames
- The closers are non-handed and tri-packed for maximum versatility to permit regular, top-jamb and parallel arm installations
- The common 9-1/16" mounting hole pattern permits simple installation on new and retrofit applications.
- Maximum 3-11/16" reveal for Top Jamb.

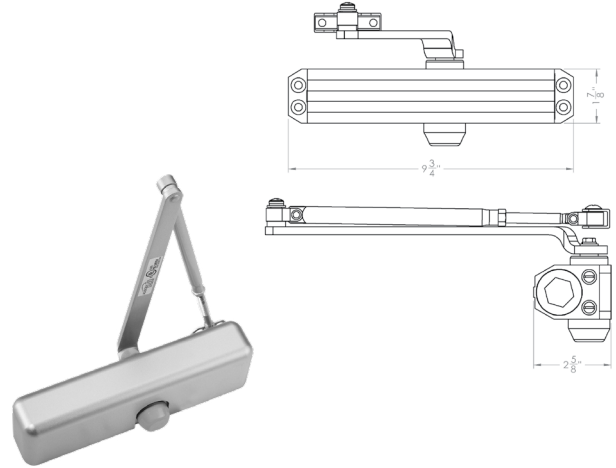

Specifications



BODY:	• High strength aluminum alloy
ARM OPTIONS:	<ul style="list-style-type: none"> • PA – Parallel Arm • PS – Pivot Stop Arm • HO – Hold Open • DS/DSHO – Heavy Duty Parallel Arm Stop • RA – Regular Arm • SCS/SCSHO – Heavy Duty Parallel Arm Cushion Stop
ADJUSTMENT:	<ul style="list-style-type: none"> • Separate hydraulic backcheck standard • Hydraulic controlled closing standard
SIZE:	<ul style="list-style-type: none"> • 3101 = Adjustable  BF - 4 • 3100 = Adjustable 3 - 6
MOUNTING:	<ul style="list-style-type: none"> • Common 9-1/16" x 3/4" mounting hole pattern retrofits Yale® 50, Norton® 1600 • Tri-packed for regular, top jamb and parallel arm installations • Includes sex nuts/bolts and screws for wood, metal doors frames • Self drilling self tapping screws standard • Separate limiting stop may be required for high abuse applications
COVER:	• Streamline plastic cover optional
COLOR FINISHES:	• 689 – Aluminum, 693 – Black, 695 – Duro Bronze, 696 – Gold
WARRANTY:	• Twenty-five (25) year Limited Warranty
CERTIFICATIONS COMPLIANCES:	<ul style="list-style-type: none"> • UL listed for labeled swinging fire doors rated up to and including 3 hours • Certified to ANSI/BHMA A156.4 Grade 1 • Complies with ADA (Americans with Disabilities Act) and ICC/ANSI 117.1 for Accessible and Usable Buildings • TAA compliant. Country of origin: KR

How to Order

QUANTITY	SERIES	SIZE	BACKCHECK	ARM TYPES	FINISH	ACCESSORIES
10	31	00	BC	PA	689	—
		00 – Adjustable Size 3-6 01 – Adjustable Size BF - 4 	BC – Adjustable Hydraulic Backcheck	DS – Door Saver Arm DSHO – Door Saver Hold Open Arm HO – Hold Open, Tri-Pack PA – Tri-Pack (standard) RA – Regular Arm SCS – Spring Cushion Stop SCSHO – Spring Cushion Stop Hold open PS – Pivot Stop Arm BLANK – Body Only	689 – Aluminum 693 – Black 695 – Duro Bronze 696 – Gold	BP – Back Plate BS – Blade Stop Spacer DP – Drop Plate NFB – Narrow Frame Bracket SV - Streamline Cover
						PAGE 208

Closers

PART	SIZE	DESCRIPTION	PAINTED 689/693/695/696
3100 SERIES – ADJUSTABLE SIZES 3-6			
3100 BC PA	3-6	Closer, SNB (Tri-pack)	\$158.00
3100 BC RA	3-6	Closer, regular arm, SNB	
3100 BC PA SV	3-6	Closer, SNB (Tri-pack), Streamline Cover	\$168.00
3100 BC PA HO	3-6	Closer, hold open, SNB (Tri-pack)	\$247.00
3100 BC DS	3-6	Closer, door saver, SNB (PA Only)	\$281.00
3100 BC DSHO	3-6	Closer, door saver hold open, SNB (PA Only)	\$307.00
3100 BC SCS	3-6	Closer, door saver w/spring cushion stop, SNB (PA Only)	\$370.00
3100 BC SCSHO	3-6	Closer, door saver hold open w/spring cushion stop,SNB (PA Only)	
3100 BC PS	3-6	Closer, pivot stop (SNB for closer body only)	
3100 BC TA	3-6	Closer, track arm, streamline cover (SNB for closer body only)	\$250.00
3100 BC TAHO	3-6	Closer, rack arm hold open, streamline cover (SNB for closer body only)	\$260.00
3100 BC	3-6	Closer, body only	\$120.00
3101 SERIES – ADJUSTABLE SIZES BF-4			
3101 BC PA	BF-4	Closer, SNB (Tri-pack)	\$158.00
3101 BC RA	BF-4	Closer, regular arm, SNB	
3101 BC PA SV	BF-4	Closer, SNB (Tri-pack), Streamline Cover	\$168.00
3101 BC PA HO	BF-4	Closer, hold open, SNB (Tri-pack)	\$247.00
3101 BC DS	BF-4	Closer, door saver, SNB (PA Only)	\$281.00
3101 BC DSHO	BF-4	Closer, door saver hold open, SNB (PA Only)	\$307.00
3101 BC SCS	BF-4	Closer, door saver w/ spring cushion stop, SNB (PA Only)	\$370.00
3101 BC SCSHO	BF-4	Closer, door saver hold open w/spring cushion stop, SNB (PA Only)	
3101 BC TA	3-6	Closer, track arm, streamline cover (SNB for closer body only)	
3101 BC TAHO	3-6	Closer, rack arm hold open, streamline cover SNB for closer body only)	\$250.00
3101 BC PS	BF-4	Closer, pivot stop (SNB for closer body only)	\$260.00
3101 BC	BF-4	Closer, body only	\$120.00

Accessories

CODE	DESCRIPTION	LIST PRICE
		PAINTED 689/693/695/696
BS	Blade Stop Spacer (no finish)	\$80.00
BP	Back Plate	
DPTJ	Drop Plate Top Jamb	
NFB	Parallel Arm NHO Bracket	\$48.00
SDST	Self Drilling Self Tapping Screws	\$12.00

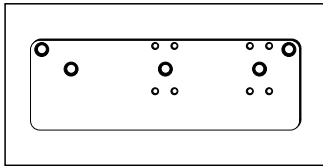

BP - BACK PLATE

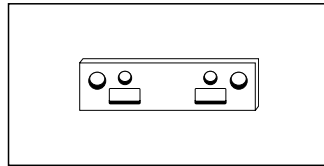

BS - BLADE STOP SPACER

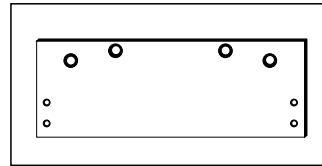

DPTJ - DROP PLATE

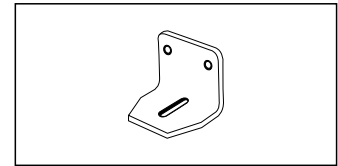

NFB - NARROW FRAME BRACKET

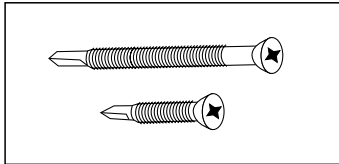

SDST - SELF DRILLING SELF TAPPING SCREWS

Spring Cushion Stops



**605
BRIGHT
BRASS**



**613E DARK OX-
IDIZED SATIN
BRONZE**



**630 SATIN
STAINLESS
STEEL**



693 BLACK

PDQ's SCS Series Spring Cushion Stop helps reduce wear and tear on the opening. As the door begins moving through back check to its maximum opening angle, the stop acts as a shock absorber, dampening the impact forces — See page 223

Arms

CODE	DESCRIPTION	PART NO. (SPECIFY FINISH)	LIST PRICE
			PAINTED 689/693/695/696
RA	REGULAR ARM - Can be mounted REG/TJ/PA (requires PA bracket)	319003	\$80.00
DS	DOOR SAVER ARM (Limiting Stop) - PA application only	999005	\$160.00
DSHO	DOOR SAVER HOLD OPEN ARM (limiting stop) PA application only	999016	\$194.00
HO	HOLD OPEN ARM - can be mounted REG/TJ/PA (requires PA bracket)	999002	\$122.00
PA	PARALLEL ARM BRACKET - NON HOLD OPEN applications	999001	\$22.00
PAHO	PARALLEL ARM BRACKET- HOLD OPEN applications	999022	\$33.00
PS	PIVOT STOP ARM - Regular and Top Jamb Only	319018	\$184.00

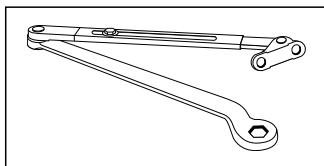

RA - REGULAR ARM

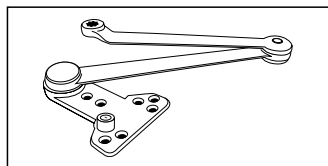

DS - DOOR SAVER (LIMITING STOP) ARM

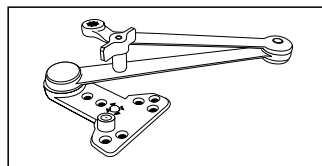

DSHO - DOOR SAVER (LIMITING STOP) HOLD OPEN ARM

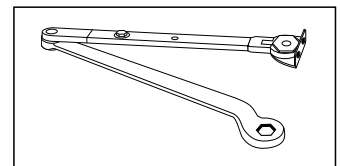

HO - HOLD OPEN ARM

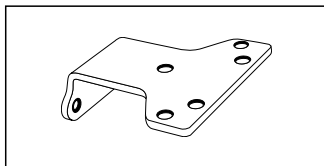

PA - PARALLEL ARM BRACKET

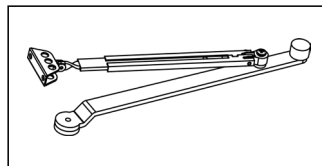
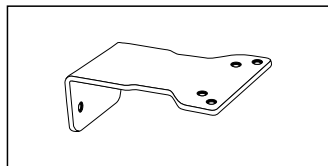

PS - PIVOT STOP ARM

3100 SERIES
DOOR CLOSERS

Covers

CODE	DESCRIPTION	PART NO. (SPECIFY FINISH)	LIST PRICE
			PAINTED 689/693/695/696
SV	STREAMLINE PLASTIC COVER	319006	\$17.00

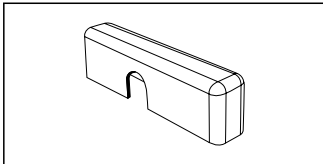

SV - STREAMLINE PLASTIC COVER

Mounting Plates

CODE	DESCRIPTION	PART NO. (SPECIFY FINISH)	LIST PRICE
			PAINTED 689/693/695/696
BS*	BLADE STOP SPACER - Shims all PA brackets to clear 1/2" blade stop (no finish)	999026	\$80.00
BP	BACK PLATE - For regular arm applications to clear mortised stop/holder	319008	
DPTJ	TOP JAMB DROP PLATE - Required to mount TJ with limited ceiling clearance or to clear surface applied stop/holder	319009	
NFB	NARROW FRAME BRACKET - For DS/DSHO/EDS/EDAHO arms, PA and BS brackets for added reinforcement (no finish)	999011	\$48.00

*Note: When using a Blade Stop Spacer in a narrow frame application you must use the (NFB) Narrow Frame Bracket for proper support.

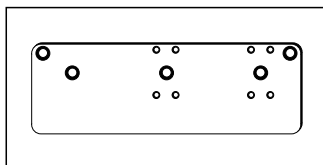

BP - BACK PLATE

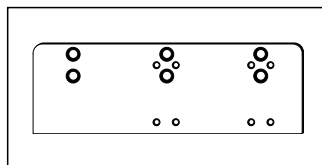

DPTJ - TOP JAMB DROP PLATE

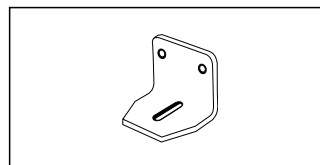

NFB - NARROW FRAME BRACKET

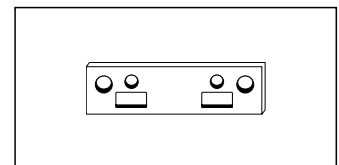

BS - BLADE STOP SPACER

Fasteners

CODE	DESCRIPTION	PART NO. (SPECIFY FINISH)	LIST PRICE
			PAINTED 689/693/695/696
SDST	SELF DRILLING SELF TAPPING SCREWS	999007	\$12.00
SP	SCREW PACK	319020	
SNB	SEX NUTS AND BOLTS -For through bolting on unreinforced hollow core, composite or labeled fire doors 1-3/4" only. (set of 4 each)	999004	

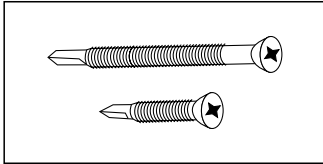

SDST - SELF DRILLING SELF TAPPING SCREWS

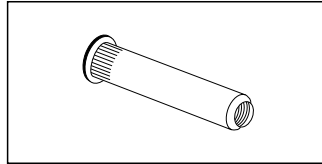

SNB - SEX NUTS AND BOLTS

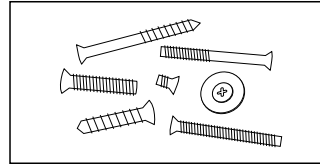

SP - SCREW PACK

Parts

CODE	DESCRIPTION	PART NO. (SPECIFY FINISH)	LIST PRICE
			PAINTED 689/693/695/696
DSBS	DOOR SAVER BUMPER STOP - (no finish) Used on DS, DSHO, PS arms	999010	\$22.00
SPBL	PLASTIC SPACER BLOCK - For DS/DSHO/EDA/EDAHO and PA soffit brackets (no finish)	999031	\$10.00
SCS	SPRING CUSHION STOP* - USE with DS/DSHO for 3'0" doors (specify finish), for PA mount arms only	999032	\$150.00
SCS	SPRING CUSHION STOP* - For DS/DSHO for 4'0" doors, (specify finish), for PA mount arms only	999033	

* Spring Cushion Stop requires purchase of a PDQ DS or DSHO arm.

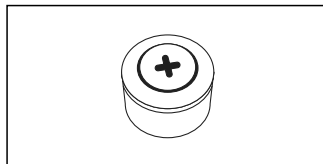

DSBS - DOOR SAVER BUMPER STOP

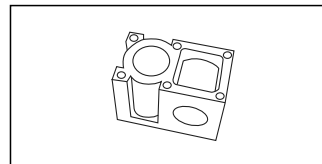

SPBL - PLASTIC SPACER BLOCK

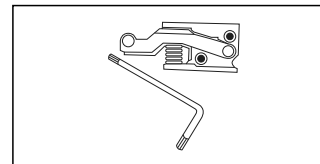

HO KIT - TA ARM TO MAKE TAHO

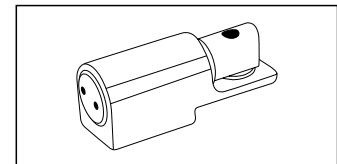

SCS - SPRING CUSHION STOP

Spring Cushion Stop (SCS) Finish Match to Closers

SCS FINISH	CLOSER FINISH
605 (PVD)	605/696
613E (PVD)	695
630	625/626/689
693	693

Cross Reference

MANUFACTURER	CLOSER SERIES				
PDQ	7100	5500	5300	5100	3100
CAL ROYAL	CR441	CR801	CR801S	900	300
CORBIN/RUSSWIN	DC8000	DC6200	DC3200	N/A	N/A
DORMA	8900	8616FC	8616	7414/7436	3800
FALCON	SC70	SC850FC	SC80	SC60/SC61	SC60
HAGER	5100	5200	5200	N/A	5300 LESS COVER
STANLEY COMMERCIAL	QDC100	QDC200F	QDC200S	N/A	QDC300
LCN	4040	1460/1461	1460/1461	1370	1260
NORTON	7500	8500	8300	160	1600
SARGENT	281	350	1430	1130/1131	1130
STANLEY	D-4550	D-3550	N/A	N/A	D-1650
YALE	5800/4400	3500	3300	51	50

Mounting Position

Regular Arm

Regular arm mount is a pull side application with double lever arm. The closer mounts on the door and the arm mounts to the frame. It provides the most efficient operation for door control and is commonly used on in-swing doors from corridors or other interior doors. Regular arm mount is a poor choice for exterior out-swinging doors as it would put the closer on the exterior of the building. The arm assembly projects directly out from the frame. That may be a concern for vandalism or aesthetics. Regular arm application can be used with non-hold open or hold open arms.

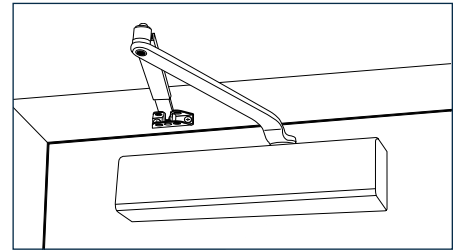

Top Jamb

Top jamb mount is a push side double lever arm application that offers the best alternative to regular arm mount. The closer mounts to the frame and the arm mounts to the door. This application is commonly used on exterior out-swinging doors. It is a poor application for in-swinging doors from a corridor as it places the closer arm in a visible application projecting into the corridor. The arm projects out similar to regular arm mount. Therefore, it can be a concern for vandalism or aesthetics. Top jamb application can be used with non-hold open or hold open arms.

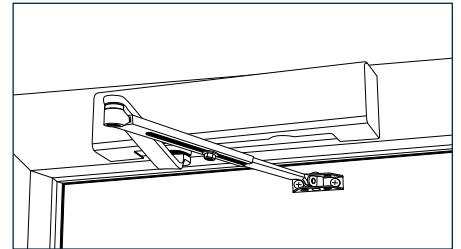

Parallel Arm

Parallel arm mount is a push side double lever arm application. The closer is installed on the push side of the door and the arm is mounted to a parallel arm adapter plate installed to the frame soffit. The arm is approximately parallel with the face of the door, eliminating the projection condition evident with regular arm and top jamb applications. Parallel arm is often preferred where aesthetics or vandalism are concerns. Parallel arm is less efficient than regular or top jamb mounts due to the geometry of the arm. Parallel arm application can be used with non-hold open or hold open arms.

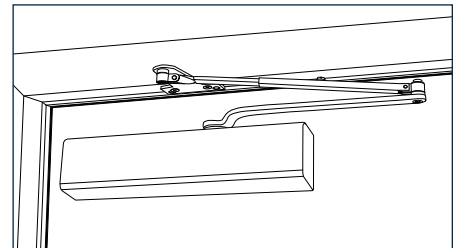

Parallel Stop Arm (DS/DSHO) Extra Duty PA Arm (EDA/EDAHO)

The parallel stop arm mount is an enhanced version of the parallel arm application. It is similar to the parallel arm mount but incorporates a heavy duty rigid arm and soffit plate with limiting dead stop. The dead stop feature is field handed. The closer's back check function should be adjusted to cushion the impact of the stop. The parallel stop arm is intended for use where an auxiliary stop cannot be utilized. The parallel stop arm is available in non-hold open (DS) and hold open (DSHO) applications.

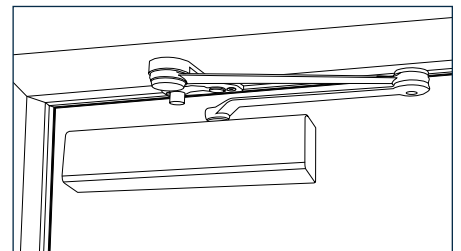

Recommend using the SCS Spring Cushion Stop for moderate to high abuse installations.

For Extra Duty PA Arm applications, specify EDA or EDAHO. Similar to DS/DSHO without the stop. Requires separate limiting stop by others.

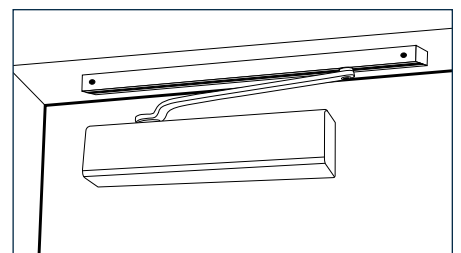

Track Arm (TA)

The non-handed Track Arm mount incorporates a single stamped arm not designed to be used as a limiting dead stop. It's low profile helps to eliminate projecting arm conditions, which can reduce vandal damage.

Pivot Stop (PS)

The PS (Pivot Stop) arm is designed to serve as a medium-duty door stop for situations where a door stop or overhead stop is not practical. Available in Regular and Top Jamb mounting, the PS arm uses back check to slow the door and a stop integrated into the closer arm to limit the travel of the door. The PS arm limits the travel of the door to a specific, templated angle. Templating is available for opening angles from 85 to 110 degrees in 5 degree increments. The PS arm is not available with hold-open.

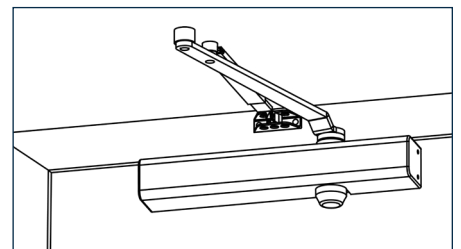

SPRING CUSHION STOP



630 SATIN STAINLESS STEEL



613E DARK OXIDIZED SATIN BRONZE



605 BRIGHT BRASS



693 BLACK

PDQ's SCS Series Spring Cushion Stop helps reduce wear and tear on the opening. As the door begins moving through backcheck to its maximum opening angle, the stop acts as a shock absorber, dampening the impact forces.

Features

- The unit is an **add-on kit** that can be included as an option on DS/DSHO arms.
- It also can be installed on existing DS/DSHO arm applications using the existing threaded hole for the bumper stop and one of the mounting screw holes.
- The spring cushion kit is available in two spring sizes, allowing it to be tailored to provide more effective cushioning for specific door widths
- Designed to be self aligning, the unit works with any door that incorporates a PDQ DS/DSHO arm with a cushioned bumper (won't fit with old style metal bumper).
- Manufactured from investment cast stainless steel for corrosion resistance and durability
- The 99032/99033 does not alter or decrease the strength of the DS/DSHO arm.
- Hand is determined in the field and reversible for LH and RH doors

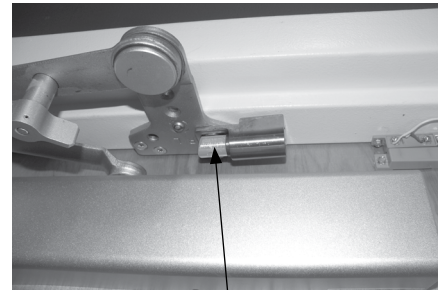

NOTE: PLUNGER HIGHLIGHTED TO ENHANCE THE CUSHIONING FEATURE.

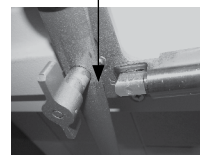

STOP SHOWN BEFORE DOOR IS FULLY OPENED

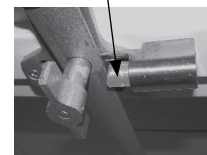

STOP SHOWN WHEN DOOR IS FULLY OPENED

Specifications



HANDING:	• Field Reversible
DOOR SIZES:	• SCS-1 for 3'0" X 8'0" doors • SCS-2 for 4'0" X 8'0" doors
FINISHES:	• 605 (US3) – Bright Brass (PVD), 613E – Dark Oxidized Satin Bronze (PVD), 630 (US32D) – Satin Stainless Steel, 693 – Black Note: PVD (Physical Vapor Deposition) coated finishes offer outstanding resistance to wear, durability and corrosion.

Spring Cushion Stop

PART	CODE	DESCRIPTION	LIST PRICE 605/613E/630/693
999032 Specify Finish	SCS-1	For 3'0" X 8'0" wood or hollow metal doors and frames	\$150.00
999033 Specify Finish	SCS-2	For 4'0" X 8'0" wood or hollow metal doors and frames	

Locks

MR199A
Electrified Mortise

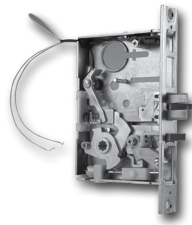

Applications

Electrified locks complement the mechanical offering and are typically incorporated into a wired access control system or used independently with a remote access switch. - p. 9

XGT/GT199A
Electrified Cylindrical

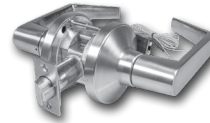

Applications

Electrified locks complement the mechanical offering and are typically incorporated into a wired access control system or used independently with a remote access switch. - p. 34

Exit Devices and Trim

6300/6400
Electrified Options



Applications

Access control exit device options including request to exit signal switch, latch bolt monitor, and battery powered alarms.

6W99
Electrified Trim



Applications

Electrified trim complements the mechanical offering and is typically incorporated into a wired access control system or used independently with a remote access switch. — p. 160

MLR
Motorized Latch Retraction

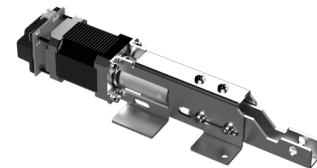

Applications

An ideal solution for integrated exitdeviceaccesscontrolsolutions requiring operational noise reduction such as Healthcare, K-12, higher education,museums, auditoriums, theaters, etc.

Electrified Hinges



Applications

Electric hinges are used when a locking device is mounted on a moving door and power and signals must be brought off the door to the controller and house wiring. Examples of such locking devices include an electrified lockset or electrically actuated trim, electric latch retraction device or a switching device such as a REX lever or touchbar. — p. 226

Electric Strikes



Applications

Electromechanical door locking device for use with various latch bolt locksets in lieu of conventional Strikes that provide additional security, traffic control and convenience of remote operation. — p. 217

Key Switches



Applications

Key switches can be activated only by the use of a key. Typical applications include situations where access needs to be restricted to the switch's functions. — p. 218

Push Buttons



Applications

Commonly used on ADA openings in conjunction with an automatic operator. — p. 218

Power Supplies

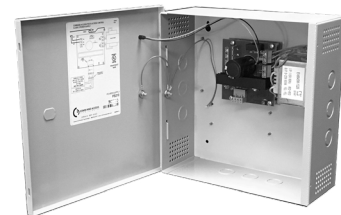

Applications

Power sources used to support electronic access control devices. — p. 219

8500 SERIES

Electric Strikes



Specifications

85001 ELECTRIC STRIKE:	• Designed for use with all PDQ Grade 1 and Grade 2 Cylindrical Locks
85003 ELECTRIC STRIKE:	• Designed for use with all PDQ MR Series Mortise Locks WITHOUT Deadbolt
FEATURES:	<ul style="list-style-type: none"> • Input voltage:12-24 VDC • Field changeable from FAIL SECURE to FAIL SAFE • Factory tested to 1,000,000 cycle
CURRENT:	<ul style="list-style-type: none"> • 0.28A @ 12 VDC • 0.14A @ 24 VDC
FINISH:	• 630 (US32D) Satin Stainless Steel

Electric Strikes

Designed for use with PDQ's Grade 1 Mortise Locks, Grade 1 and 2 Cylindrical Locks

PART NO.	DESCRIPTION	LIST PRICE
85001	For Cylindrical Locks	\$650
85003	For Mortise locks (no Deadbolt)	

8100 SERIES

Key Switches Push Buttons



Key Switch W/Lights
81310-2MT / 81310-2MM



Key Switch
81310-4MT / 81310-4MM



Push Button Switch
81320-1MT / 81320-1MM

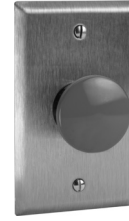

Mushroom Push Button
81320-5MT / 81320-5MM

Electrified Accessories

PART NUMBER	DESCRIPTION	LIST PRICE
81310-2MT	62 Key Switch with Lights Maintained	\$386.00
81310-2MM	62 Key Switch with Lights Momentary	
81310-4MT	62 Key Switch Narrow Maintained	\$352.00
81310-4MM	62 Key Switch Narrow Momentary	
81320-1MT	62 Push Button Maintained	\$246.00
81320-1MM	62 Push Button Momentary	
81320-5MT	62 Push Button Mushroom Maintained	\$376.00
81320-5MM	62 Push Button Mushroom Momentary	
81320-6MT	62 Push Button Narrow Maintained	\$280.00
81320-6MM	62 Push Button Narrow Momentary	

PS SERIES

Power Supplies



MADE IN
THE USA

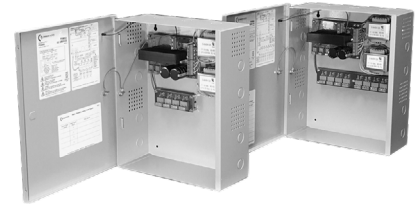
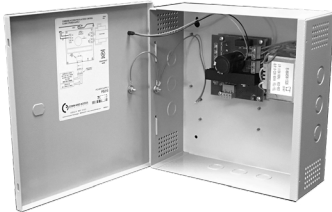

Features

- Filtered/Regulated 24 Volts DC
- Overload, Over Voltage and Short Circuit Protection
- Accepts 110-120VAC
- Controls Fail Safe or Fail Secure Locking Devices
- Interface Relay Isolates Locking Device Current from Control Switch
- Auxiliary 24VDC Constant Voltage Output for Powering Stand Alone Devices, Such as, Keypads, Motion Detectors and Status Indicators (Model PS220 and PS22B only)
- Surge Suppression on Fail Safe and Fail Secure Outputs
- UL Listed and Tested to 294 Standard for Access Control System Units
- 3 year warranty
- Made in the USA



PART	DESCRIPTION	LIST PRICE
PS220	2A @ 24VDC Power Supply w/ Fire Alarm Link and 0.5A auxiliary power (continuous)	\$950.00
PS220B	2A @ 24VDC Power Supply w/ Fire Alarm Link, 0.5A auxiliary power (continuous) and Battery Backup (batteries sold separately)	\$1077.00
PS440B	4A @ 24VDC Power Supply w/ Fire Alarm Link, and Battery Backup (batteries sold separately)	\$1152.00
PS480B	8A @ 24VDC Power Supply w/ Fire Alarm Link, and Battery Backup. Batteries not included (accommodates 2 ea. 7AH batteries)	\$1224.00

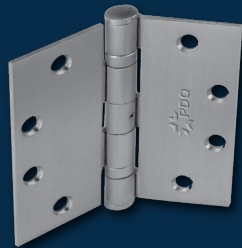

Commercial Hinges



Electrified Hinges

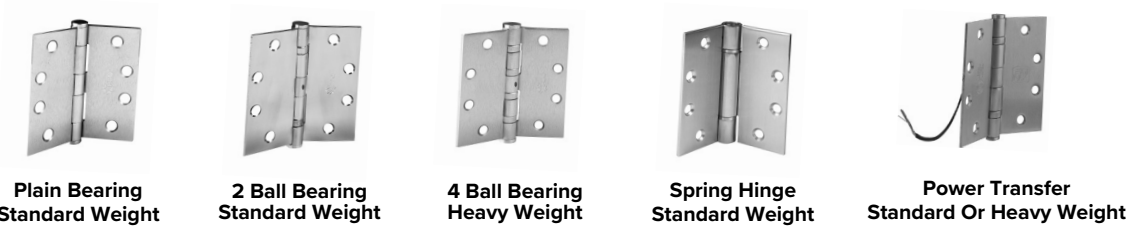

Specifications



MATERIALS:	<ul style="list-style-type: none"> • STEEL — Applications: Interior doors, non-corrosive environments. • STAINLESS STEEL — Applications: Exterior, doors, corrosive environments
PACKAGING:	<ul style="list-style-type: none"> • Qty Of Hinges Per Individual Carton: 3 ea For Plain, 2 Ball Bearing and 4 Ball Bearing Hinges 3 ea For Spring Hinges 1 ea for Electrified Hinges • Qty Of Hinges Per Master Carton: 48 ea For Plain, 2 Ball Bearing and 4 Ball Bearing Hinges
FASTENERS:	<ul style="list-style-type: none"> • All hinges packed with Machine Screws (12-24 x 1/2" FHMS) and Wood Screws (12 x 1-1/4" FHWS)
CERTIFICATIONS, LISTINGS, COMPLIANCES:	<ul style="list-style-type: none"> • Conforms with the requirements of NFPA 80-2010, Section 6.4.3.1. • Certified to ANSI/BHMA A156.1-2013: <ul style="list-style-type: none"> — Grade 3, Plain Bearing (PL) 350,000 cycles — Electrified hinges tested to over 100,000 cycles • UL listed: <ul style="list-style-type: none"> — SH Series Spring Hinges — EL Series Electrified Hinges
WARRANTY:	<ul style="list-style-type: none"> • Five (5) year limited warranty

Cross Reference

HINGE DESCRIPTION	PDQ	ANSI	BOMMER	HAGER	MCKINNEY	PBB	STANLEY
Plain Bearing, Standard Weight – Steel	35STPL	A8133	5000	1279	T2714	PB81	F179
				EC1100	MP79		
2 Ball Bearing, Standard Weight – Steel	35STBB	A8112	BB5000	BB1279	TA2714	BB81	FBB179
				ECBB1100	MPB79		
2 Ball Bearing, Standard Weight – Stainless Steel	35SSBB	A5112	BB5002	BB1191	TA2314	BB51	FBB191
				(630/32D)	(630/32D)		
4 Ball Bearing, Heavy Weight – Steel	35STHB	A8111	BB5004	BB1168	T4A3786	4B81	FBB168
				ECBB1102	MPB68		
4 Ball Bearing, Heavy Weight – Stainless Steel	35SSHB	A5111	BB5006	BB1199	T4A3386	4B51	FBB199
				ECBB1103	MPB68		
Spring Hinge, Self Closing – Steel	35STSH	K8107-1F	LB4310C	1250	1502	SP81	2060R
				EC1105	MPS60		

Quick Reference Guide

PDQ HINGE MODEL*	FINISH ANSI (US)	ANSI NUMBER*	STYLE	BASE MATERIAL	SIZE	FREQUENCY	WEIGHT	THICK-NESS	SWAGING
FULL MORTISE HINGES									
35 ST PL 4040 600	600 (P)	A8133	PLAIN	STEEL	4" x 4"	LOW		.130"±.005"	2 LEAVES
35 ST PL 4040 652	652 (26D)								
35 ST PL 4545 600	600 (P)								
35 ST PL 4545 613E	613E (10B)								
35 ST PL 4545 652	652 (26D)								
35 ST BB 4545 600 NRP	600 (P)	A8112 w/NRP	2 BALL BEARING	STEEL	4-1/2" x 4-1/2"	STANDARD			
35 ST BB 4545 605 NRP	605 (3)								
35 ST BB 4545 613E NRP	613E (10B)								
35 ST BB 4545 652 NRP	652 (26D)								
35 ST BB 4540 652 NRP									
35 SS BB 4035 630 NRP	630 (32D)	A5112 w/NRP		STAINLESS STEEL	4" x 3-1/2"	MEDIUM			
35 SS BB 4040 630 NRP					4" x 4"				
35 SS BB 4540 630 NRP					4-1/2 x 4"				
35 SS BB 4545 630 NRP									
35 ST HB 4545 600 NRP					600 (P)			A8111 w/NRP	4 BALL BEARING
35 ST HB 4545 605 NRP	605 (3)								
35 ST HB 4545 613E NRP	613E (10B)								
35 ST HB 4545 652 NRP	652 (26D)								
35 ST HB 5045 652 NRP									
35 SS HB 4545 630 NRP	630 (32D)	A5111 w/NRP		STAINLESS STEEL	4-1/2" x 4-1/2"				
35 SS HB 5045 630 NRP					5" x 4-1/2"				
SPRING HINGES									
35 ST SH 4545 613E	613E (10B)	K8107-1F		STEEL	4-1/2" x 4-1/2"	MEDIUM	STANDARD	.134+-.005	2 LEAVES
35 ST SH 4545 613E	613E (10B)								
35 ST SH 4545 652	652 (26D)								
35 SS SH 4545 630	630(32D)	K5107-1F		STAINLESS STEEL					
ELECTRIFIED HINGES									
See Full Mortise Hinge Table above, 2 and 4 Ball Bearing Series.									

*NRP = Non-Removable Pin

How to Order



QUANTITY	SERIES	MATERIAL	STYLE	SIZE	FINISH	SECURITY FEATURE ²	ELECTRIFIED OPTIONS ¹
10	35	ST	BB	4545	630	NRP	—
	35 — Full Mortise	ST — Steel SS — Stainless Steel	PL — Plain Bearing BB — 2 Ball Bearing HB — 4 Ball Bearing SH — Spring Hinge	4035 — 4" X 3-1/2" 4040 — 4" X 4" 4540 — 4-1/2" X 4" 4545 — 4-1/2" X 4-1/2" 5045 — 5" x 4-1/2" 5050 — 5" x 5"	600 — Prime Coated 605 — Bright Brass 613E — Oil Rub Bronze 619 — Satin Nickel 626 — Satin Chrome 630 — Satin Stainless Steel	NRP — Non Removable Pin	EL 4 — Concealed electric through-wire (2 wires @ 20ga, 2 wires @ 26ga) EL 8 — Concealed electric through-wire (8 wires, 28ga)

Ordering example: Plain bearing hinge: 35 ST PL 4545 600
4 Wire Std Weight Hinge: EL 4 35 SS BB 4545 630 NRP







Notes:

- 1- EL Series only available in 2 and 4 ball bearing. Includes NRP.
- 2 - NRP standard in 2 and 4 ball bearing.





Plain Bearing

FULL MORTISE HINGES	DESCRIPTION	QTY OF HINGES PER CARTON	FINISH ANSI (US)	PDQ HINGE MODEL	LIST PRICE PER HINGE
	5 Knuckle Base Material: Steel Size: 4" x 4" Hinge Weight: Standard Frequency of Use: Low Thickness: .130" ± .005" Certified to ANSI 8133	3ea	600 (P)	35 ST PL 4040 600	\$10.00
			652 (US26D)	35 ST PL 4040 652	
	5 Knuckle Base Material: Steel Size: 4-1/2" x 4-1/2" Hinge Weight: Standard Frequency of Use: Low Thickness: .130" ± .005" Certified to ANSI 8133	3ea	600 (P)	35 ST PL 4545 600	\$11.00
			613 (10B)	35 ST PL 4545 613	
			619(US15)	35 ST PL 4545 619	
			652 (US26D)	35 ST PL 4545 626	

2 Ball Bearing

FULL MORTISE HINGES	DESCRIPTION	QTY OF HINGES PER CARTON	FINISH ANSI (US)	PDQ HINGE MODEL	LIST PRICE PER HINGE
	5 Knuckle Base Material: Stainless Steel Size: 4" x 3-1/2" Hinge Weight: Standard Frequency of Use: Medium Thickness: .118" ± .005" Certified to ANSI A5112	3ea	630 (US32D)	35 SS BB 4035 630 NRP	\$29.00
	5 Knuckle Base Material: Stainless Steel Size: 4" x 4" Hinge Weight: Standard Frequency of Use: Medium Thickness: .118" ± .005" Certified to ANSI A5112	3ea	630 (US32D)	35 SS BB 4040 630 NRP	\$32.00
	5 Knuckle Base Material: Steel Size: 4-1/2" x 4" Hinge Weight: Standard Frequency of Use: Medium Thickness: .134" ± .005" Certified to ANSI A8112	3ea	652 (US26D)	35 ST BB 4540 626 NRP	\$10.00
	5 Knuckle Base Material: Stainless Steel Size: 4-1/2" x 4" Hinge Weight: Standard Frequency of Use: Medium Thickness: .134" ± .005" Certified to ANSI A5112	3ea	630 (US32D)	35 SS BB 4540 630 NRP	\$35.00
	5 Knuckle Base Material: Steel Size: 4-1/2" x 4-1/2" Hinge Weight: Standard Frequency of Use: Medium Thickness: .134" ± .005" Certified to ANSI A8112	3ea	600 (P)	35 ST BB 4545 600 NRP	\$11.00
			605 (US3)	35 ST BB 4545 605 NRP	\$15.00
			613 (10B)	35 ST BB 4545 613 NRP	\$15.00
			619(US15)	35 ST BB 4545 619 NRP	\$15.00
	5 Knuckle Base Material: Stainless Steel Size: 4-1/2" x 4-1/2" Hinge Weight: Standard Frequency of Use: Medium Thickness: .134" ± .005" Certified to ANSI A5112	3ea	652 (US26D)	35 ST BB 4545 652 NRP	\$11.00
			630 (US32D)	35 SS BB 4545 630 NRP	\$35.00

4 Ball Bearing

FULL MORTISE HINGES	DESCRIPTION	QTY OF HINGES PER CARTON	FINISH ANSI (US)	PDQ HINGE MODEL	LIST PRICE PER HINGE
	5 Knuckle Base Material: Steel Size: 4-1/2" x 4-1/2" Hinge Weight: Heavy Frequency of Use: High Thickness: .180" ± .005" Certified to ANSI 8111	3ea	600 (P)	35 ST HB 4545 600 NRP	\$26.00
			605 (US3)	35 ST HB 4545 605 NRP	\$32.00
			613 (10B)	35 ST HB 4545 613 NRP	\$26.00
			619 (US15)	35 ST HB 4545 619 NRP	\$26.00
			652 (US26D)	35 ST HB 4545 626 NRP	\$26.00
	5 Knuckle Base Material: Stainless Steel Size: 4-1/2" x 4-1/2" Hinge Weight: Heavy Frequency of Use: High Thickness: .180" ± .005" Designed to meet ANSI 5111	3ea	630 (32D)	35 SS HB 4545 630 NRP	\$60.00
	5 Knuckle Base Material: Steel Size: 5" x 4-1/2" Hinge Weight: Heavy Frequency of Use: High Thickness: .180" ± .005" Designed to meet ANSI 8111	3ea	652 (US26D)	35 ST HB 5045 626 NRP	\$38.00
	5 Knuckle Base Material: Stainless Steel Size: 5" x 4-1/2" Hinge Weight: Heavy Frequency of Use: High Thickness: .180" ± .005" Designed to meet ANSI 5111	3ea	630 (32D)	35 SS HB 5045 630 NRP	\$77.00
	5 Knuckle Base Material: Stainless Steel Size: 5" x 5" Hinge Weight: Heavy Frequency of Use: High Thickness: .180" ± .005" Designed to meet ANSI 5111	3ea	630 (32D)	35 SS HB 5050 630 NRP	\$90.00



Spring Hinges

SPRING HINGES	DESCRIPTION	QTY OF HINGES PER CARTON	FINISH ANSI (US)	PDQ HINGE MODEL	LIST PRICE PER HINGE
	3 Knuckle Base Material: Steel Size: 4-1/2" x 4-1/2" Hinge Weight: Standard Frequency of Use: Medium Thickness: .134" ± .005" Designed to meet ANSI K8107-1F	3ea	600 (P)	35 ST SH 4545 600	\$28.00
			613 (10B)	35 ST SH 4545 613	
			619 (US15)	35 ST SH 4545 619	
			652 (US26D)	35 ST SH 4545 626	
			605 (US3)	35 ST SH 4545 605	
	3 Knuckle Base Material: Stainless Steel Size: 4-1/2" x 4-1/2" Hinge Weight: Standard Frequency of Use: Medium Thickness: .134" ± .005" Designed to meet ANSI K5107-1F	3ea	630 (32D)	35 SS SH 4545 630	\$64.00

Prepackaged Hinge Sets — Everything you could need, in one convenient package.

	DESCRIPTION	FINISH	PDQ PART NUMBER	LIST PRICE PER KIT
	2-Spring Hinge 4545 1-Ball Bearing Hinge	626	35 ST SHP 4545 626	\$64.00

Electrified Hinges

	FEATURES	QTY OF HINGES PER CARTON	CODE	DESCRIPTION	HINGE ADJUSTMENT
		1ea	EL 4	Concealed electric through-wire (2 wires @ 20ga, 2 wires @ 26ga)	\$475.00
			EL 8	Concealed electric through-wire (8 wires, 28ga)	\$550.00

Accessories

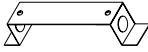
PART	DESCRIPTION	LIST PRICE
 85004	MORTAR GUARD FOR ELECTRIFIED HINGES	\$80.00



Privacy Latches
SEE PAGE 228



Flush and Surface Bolts
SEE PAGE 229

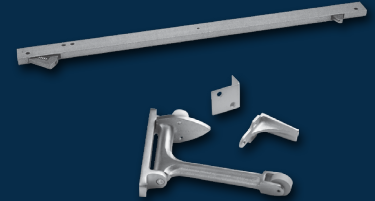

Coordinators
SEE PAGE 232



Push Plates
SEE PAGE 235



Pulls and Pull Plates
SEE PAGE 237

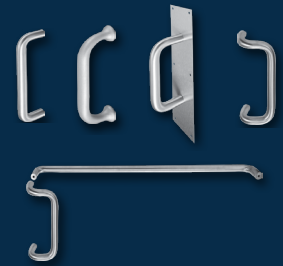

Push and Push-Pull Bars
SEE PAGE 244

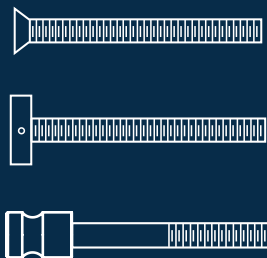

Fasteners
SEE PAGE 246

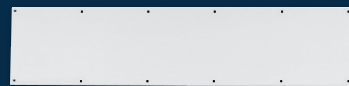

Door Protection Plates
SEE PAGE 248

Great Solution for Hospitality and Dormitories



Features





- Perfect for situations with hall-to-room openings, such as, hotels, student housing or apartments.
- Prevents accidental lock out from the conventional flip-latch.
- Allows the door to be opened for identification while providing privacy for the guest or resident.
- Keeps guest from (illegally) propping open entry fire doors.
- Does not allow the door to be held open, avoiding door and frame damage.
- Meets the requirements of FPPA 80 Sections 5.2.4.2 and 5.2.13.3 that requires auxiliary hardware does not interfere or prohibit the proper operation of fire rated doors, and that doors are not blocked or wedged in the open position.
- Easy to install, fast retrofit.
- ADA Compliant.
- Simple to operate for guest or residents.



MODEL	DESCRIPTION	LIST PRICE 626
579	Privacy Door Latch	\$58.00



Flush Bolts - Manual

MODEL (SPECIFY FUNCTION)	DESCRIPTION	LIST PRICE		
		605	613	626
HOLLOW METAL DOOR				
 93170	Flush Bolt, ANSI Type L04251 (1 ea)		\$40.00	
COMPOSITE WOOD DOORS				
 93270	Flush Bolt, ANSI Type L04261 (1 ea)		\$48.00	

Flush Bolts - Automatic







MODEL (SPECIFY FUNCTION)	DESCRIPTION	LIST PRICE		
		605	613	626
HOLLOW METAL DOOR				
 93101	Flush Bolts, ANSI Type 25 (Included as a Pair)		\$250.00	
 93102	Flush Bolts - Push Button Release, ANSI Type 27 (Included as a Pair)			
 93103	Flush Bolt - with Fire Pin, ANSI Type L04021 (Included as a Pair)			
COMPOSITE WOOD DOORS				
 93201	Flush Bolts, ANSI Type 25 (Included as a Pair)		\$265.00	
 93202	Flush Bolts - Push Button Release, ANSI Type 27 (Included as a Pair)			
 93203	Flush Bolt - with Fire Pin, ANSI Type L04021			

FLUSH BOLTS

LIST PRICE

Accessories

Effective July 3, 2023

MODEL (SPECIFY FUNCTION)	DESCRIPTION	LIST PRICE		
		605	613	626
 99101	Includes 93101 Series Automatic Flush Bolt, for Metal Doors (Specify Finish) (1 each)		\$140.00	
 99102	Includes 93102 Series Top Flush Bolt w/Push Button Release (Specify Finish) (1 each)			
 99201	Includes 93201 Series Flush Bolt for Wood Doors (Specify Finish) (1 each)		\$150.00	
 99202	Includes 93202 Series Top Flush Bolt w Push Button Release for Wood Doors (Specify Finish) (1 each)			
 909	Dust Proof Strike (Specify Finish), (1 each)		\$42.00	
 629030	Fire Pin for Hollow Metal Doors and Composite Wood Doors ¹ , (1 each)		\$66.00	
 93170E	24" Extension Rod for 93170 Series Manual Flush Bolts, (1 each)		\$15.00	

Notes: 1 - For fire labeled doors, must be used with PDQ UL fire listed automatic flush bolts to maintain UL listing status and fire code compliance.

Cross Reference



	PDQ	ABH	DCI	HAGER	IVES	ROCKWOOD	TRIMCO
DOOR TYPE	MANUAL FLUSH BOLTS						
HOLLOW METAL	93170	1855S	780F	282D	FB458	555	3917-12
COMPOSITE WOOD	93270	1875S	790F	283D	FB358	557	3913
DOOR TYPE	AUTOMATIC FLUSH BOLTS						
HOLLOW METAL	93101	1860P	842	292D	FB31P	2842	3810x3810
	93102	—	845	293D	FB51P	2845	3820x3810
	93103	—	805/8BFB	295M	FB52	2848	3820x3850
COMPOSITE WOOD	93201	1862P	942	291D	FB41P	2942	3815x3815L
	93202	—	945	293D	FB61P	2945	3825x3815L
	93203	—	960/9BFB	295W	FB42	2948	3815x3850

SURFACE BOLTS

LIST PRICE

Effective July 3, 2023

Surface Bolts

MODEL	DESCRIPTION	LIST PRICE
 460 626	Surface Bolt - 8" (Includes Top and Bottom Strikes)	\$35.00
 461 626	Surface Bolt - 12" (Includes Top and Bottom Strikes)	\$42.00
 462 626	Surface Bolt - 8" Concealed Anti-Vandal Mounting (Includes Top and Bottom Strikes)	



ANSI Type 21A Coordinators



Features

- Non-handed.
- Override protection to prevent damage in case of abnormal force on door
- Mechanism and filler bar completely fill width of opening
- Suitable for painting to match door and frame finish



Specifications

BASE MATERIAL:	• Steel
FASTENERS:	• 8 Ea. 12-24 x 1-1/4 PH MS. • 6 Ea. #8 x 3/4" Combo Screws. • Strike Plates.
FINISHES:	• 600 (USP) primer
COORDINATOR SIZES:	• COR42: 1-5/8W" x 5/8"H x 42L" • COR52: 1-5/8W" x 5/8"H x 52L" • COR60: 1-5/8W" x 5/8"H x 60L"
CERTIFICATIONS, LISTINGS, COMPLIANCES:	• UL listed for 3 hours for use with a pair of swing doors incorporating an astragal • Complies with ANSI/BHMA156.3 Type 21A • TAA compliant. Country of origin: Taiwan

How to Select the Right Size Coordinator

DOOR OPENING WIDTH	MODEL NUMBER	COORDINATOR PART NUMBER	COORDINATOR LENGTH	FILLER PART NUMBER	FILLER LENGTH
48"-54"	COORD54	COR42	42"	FB18	18"
55"-60"	COORD60	COR52	52"	FB18	18"
61"-72"	COORD72	COR52	52"	FB20	20"
73"-96"	COORD96	COR60	60"	FB36	36"

Coordinator size and length is a function of the active door size. It is recommended the coordinator extend a min of 6" beyond the active door width.

EXAMPLES:

- 1 — Active door with astragal = 48", inactive door = 48".
Recommended Coordinator Model: COORD96
- 2 — Active door with astragal = 36", inactive door = 36".
Recommended Coordinator Model: COORD72
- 3 — Active door with astragal = 36", inactive door = 24".
Recommended Coordinator Model: COORD60

NOTE: If stop height dimension is other than 58" contact PDQ Technical Service

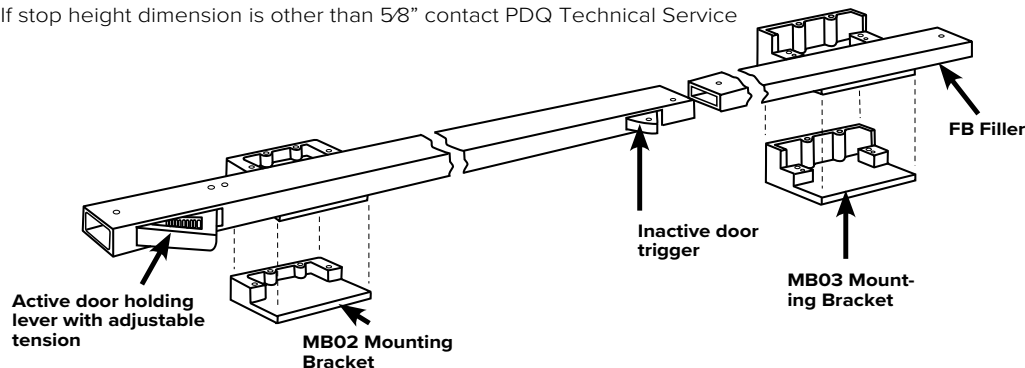
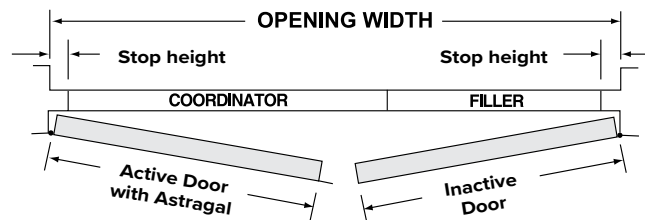

How to Order

DOOR OPENING WIDTH	MOUNTING BRACKET OPTION	FINISH
<p>COORD72</p> <p>COORD 54 — For Door Widths From 48" - 54" COORD 60 — For Door Widths From 55" - 60" COORD 72 — For Door Widths From 61" - 72" COORD 96 — For Door Widths From 73 - 96"</p>	<p>MB02</p> <p>MB02 — Mounting Bracket - Soffit over 2-1/4" MB03 — Mounting Bracket - Soffit 7/8" - 2-1/4"</p>	<p>600</p> <p>600 — USP Primer</p>

Ordering Example Door Opening Width: 72", Soffit width: 7/8": **COORD 72 MB03 600**

MODEL	DESCRIPTION	LIST PRICE 600
	COORD 54 Door Coordinator, for door widths from 48" - 54" (Includes 1ea FB18 18" Filler Bar)	\$240.00
	COORD 60 Door Coordinator, for door widths from 55" - 60" (Includes 1ea FB18 18" Filler Bar)	\$268.00
	COORD 72 Door Coordinator, for door widths from 61" - 72" (Includes 1ea FB20 20" Filler Bar)	
	COORD 96 Door Coordinator, for door widths from 73 - 96" (Includes 1ea FB36 36" Filler Bar)	\$275.00



Options

	CODE	DESCRIPTION	COORDINATOR ADJUSTMENT
	MB02	Mounting Bracket - Soffit over 2-1/4" (Included as pair)	\$75.00
	MB03	Mounting Bracket - Soffit 7/8" - 2-1/4" (Included as pair)	

Accessories

PART NUMBER	DESCRIPTION	LIST PRICE 600
COR42 600	COR42 Door Coordinator, 42", ANSI type 21A	\$195.00
COR52 600	COR52 Door Coordinator, 52", ANSI Type 21A	\$210.00
COR60 600	COR60 Door Coordinator, 60", ANSI type 21A	\$220.00
FB18 600	FB18 - Filler 18"	\$28.00
FB20 600	FB20 - Filler 20"	\$32.00
FB36 600	FB36 - Filler 36"	\$40.00

Accessories

MODEL	DESCRIPTION	LIST PRICE		
		626	689	695
 910	Carry Bar (Specify finish)	—	\$50.00	
	93590 Gravity Coordinator, 6-1/2", ANSI Type 21B	\$176.00	—	—
	93591 Gravity Coordinator, 8-1/2", ANSI Type 21B		—	—

Cross Reference

PDQ	DESCRIPTION	ABH	DCI	HAGER	IVES	ROCKWOOD	TRIMCO
COR54	Coordinator	3710	N6	297D	COR32	2660	3094A2
COR60/72	Coordinator	3720	6	297D	COR42/52	2672	3094B1
COR96	Coordinator	3730	L-6	297D	COR60/72	2696	3094C4
MB03	Mounting Bracket	3751	601AB	297M	MB-2	1601AB	3095
MB02	Mounting Bracket	3752	601C	297N	MB-1	1601C	3096
910	Carry Bar	3760	100	297C	CB1	1100	3090
93590/93591	Gravity Coordinator	3790	500	298D	COR7G	576	3093

Specifications



MOUNTING FASTENERS:	• #6 x 5/8 OH PH SMS
MATERIAL:	• Brass, Stainless Steel
THICKNESS:	• 0.050"
STANDARD CUTOUT FOR CYLINDER:	• 1-1/4" DIA
STANDARD CUTOUT FOR THUMBTURN:	• 3/8" DIA
FINISHES:	<ul style="list-style-type: none"> • 605 (US3) Bright Brass, 606 (US4) Satin Brass, 612 (US10) Satin Bronze, 613E Dark Oxidized Satin Bronze, 628 (US28) Aluminum - Anodized, 630 US32D) Satin Stainless Steel • Antimicrobial Coating available on 630 (US32D) only

Plates are available with optional cutout for cylinders or thumbturns

OPTIONS FOR LOCKING HARDWARE

PREPS FOR THUMBTURNS

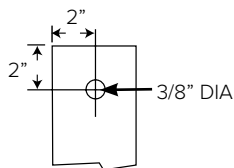

962/963 SERIES RH
RIGHT HAND SHOWN

PREPS FOR CYLINDERS

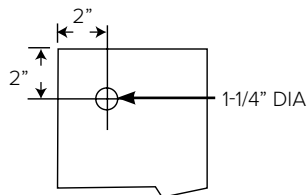
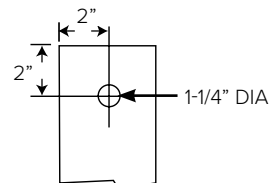

965/966 SERIES RH
RIGHT HAND SHOWN

HANDING

IN SWING DOOR

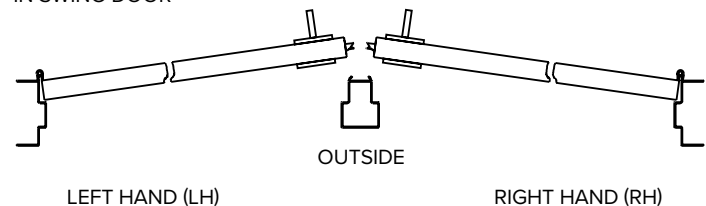

OUT SWING DOOR

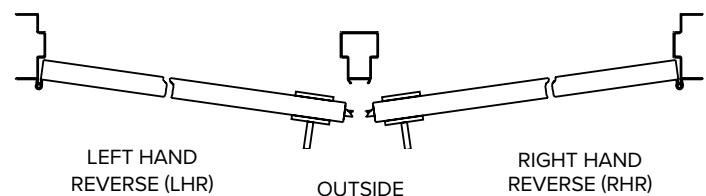

PULL POSITIONING

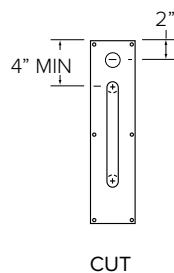
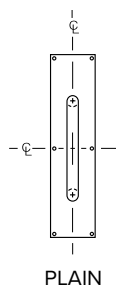

RECOMMENDED MOUNTING LOCATIONS

Note: Complies with ADA (Americans with Disabilities Act) Guidelines

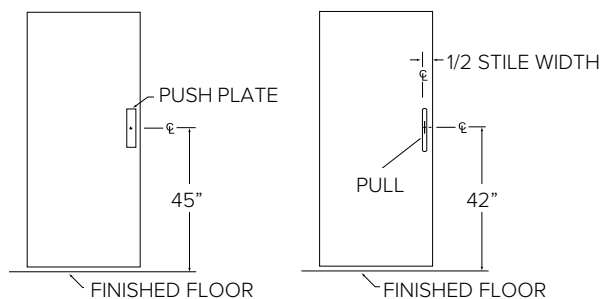

How to Order

QUANTITY	SERIES	PLATE THICKNESS	SIZE	FINISH	HANDING	OPTIONS
10	9	6	2	630	RH	—
Ordering Example: 9 6 2 630		6 — .050"	2 — 3-1/2" X 15" 3 — 4" X 16" 5 — 6" X 16" * 6 — 8" X 16" *	605 — Bright Brass 606 — Satin Brass 612 — Satin Bronze 613E — Dark Oxidized Satin Bronze 628 — Satin Aluminum, Anodized 630 — Satin Stainless Steel	RH — Right Hand LH — Left Hand	CTC PREP B — 5-1/2" CTC C — 6" CTC D — 8" CTC E — 10" CTC F — 12" CTC PREP FOR LOCKING HARDWARE C — Cylinder T — Thumbturn AM — Antimicrobial Coating

* 630 Only

MODEL (Specify Finish)	DESCRIPTION	LIST PRICE					
		630	605	606	612	613E	628
962	Push Plate 0.050" thick x 3-1/2"W x 15"H	\$20.00		\$40.00			\$20.00
963	Push Plate 0.050" thick x 4"W x 16"H	\$30.00		\$50.00			\$30.00
965	Push Plate 0.050" thick x 6"W x 16"H	\$40.00			—		
966	Push Plate 0.050" thick x 8"W x 16"H	\$50.00			—		

Options

CODE	DESCRIPTION	PLATE ADJUSTMENT
Prep for Locking Hardware		
T	Thumbturn Prep	\$8.00
C	Cylinder Prep	
CTC Thurbolt Prep (For pull plate on opposite side)		
CTC-B	5-1/2" CTC (Center to Center)	\$8.00
CTC-C	6" CTC	
CTC-D	8" CTC	
CTC-E	10" CTC	
CTC-F	12" CTC	
AM	Antimicrobial protected coating applied to tactile surfaces	\$22.00

Notes:

1 - Handing required for Plate Size 5 and 6. 2 - Cylinder and Thumbturn Prep not available in Plate Size 2.











Specifications

MOUNTING OPTIONS:	• Varies by product, see specific product details.
SIZES:	• Varies by product, see specific product details.
FINISHES:	<ul style="list-style-type: none"> • 605 (US3) Bright Brass, 606 (US4) Satin Brass, 612 (US10) Satin Bronze, 613E Dark Oxidized Satin Bronze, 628 (US28) Aluminum - Anodized, 630 US32D) Satin Stainless Steel, see specific product for finish availability • Antimicrobial Coating available on 630 (US32D) only

How to Order

PULL	FINISH	MOUNTING	OPTIONS
2C See Models Below Ordering Example, Standard Mount: 2C 630 1 Notes: 1- See mounting options located on Page 239. 2- For Mounting Option List Price Adds, see Page 246.	630 605 — Bright Brass 606 — Satin Brass 612 — Satin Bronze 613E — Dark Oxidized Satin Bronze 626 — Satin Chrome 628 — Satin Aluminum, Anodized 630 — Satin Stainless Steel	1 SINGLE 1 — TYPE 1 (DEFAULT) Thru Bolt for Metal, Composite or Wood Door 6 — TYPE 6 Surface Concealed for Metal Door (Door Reinforcement by Others) 6R — TYPE 6R Surface Concealed for Metal Door (Rivnut) 8 — TYPE 8 Surface Concealed for Wood Door (Knife Thread Insert) 12 — TYPE 12 Thru Bolt for Metal, Composite or Wood Door, Decorative Head 15 — TYPE 15 Thru Bolt for Glass Door, Decorative Head BACK TO BACK 5 — TYPE 5 (DEFAULT) Back to Back for Metal or Wood Door 13 — TYPE 13 Back to Back for Glass Door	— AM — Antimicrobial Coating

Straight Pulls

MODEL	DESCRIPTION	LIST PRICE					
		630	605	606	612	613E	628
 1B	5/8" Round Straight Pull 5-1/2" CTC	\$30.00		\$60.00			\$20.00
 2C	3/4" Round Straight Pull 6" CTC	\$40.00		\$70.00			\$30.00
 2D	3/4" Round Straight Pull 8" CTC	\$50.00		\$80.00			\$40.00
 3D	1" Round Straight Pull 8" CTC	\$70.00		\$100.00			\$40.00
 H3D	1" Round Straight Pull 8" CTC ADA	\$78.00	—	\$108.00	—	\$108.00	—
 H3E	1" Round Straight Pull 10" CTC ADA	\$85.00	—	—	—	—	—
 H3F	1" Round Straight Pull 12" CTC ADA	\$94.00	—	—	—	—	—
 5C	1" Flat Straight Pull 6" CTC	\$68.00		\$98.00			\$38.00
 5D	1" Flat Straight Pull 8" CTC	\$78.00		\$108.00			\$48.00

For Mounting Options, see Page 239

Cast Pulls

MODEL	DESCRIPTION	LIST PRICE				
		605	606	612	613E	628
 11	Cast Pull 5-1/2" CTC	\$38.00				

MODEL	DESCRIPTION	LIST PRICE		
		626	605	613E
 12	Cast Pull, Surface Mount, 5-1/2" CTC	\$58.00		

Offset Pull

MODEL	DESCRIPTION	LIST PRICE 630
 9E	1" Round Offset Pull Handle, 10" CTC	\$175.00

For Mounting Options, see Page 239

Back to Back Pulls

MODEL	DESCRIPTION	LIST PRICE				
		630	605	606	612	613E
 22C 22D	3/4" Round Straight BTB Pull 6" CTC	\$95.00	\$125.00			
	3/4" Round Straight BTB Pull 8" CTC	\$110.00	\$140.00			
H33D	1" Round Straight BTB Pull 8" CTC ADA	\$200.00	-			
 H33E H33F	1" Round Straight BTB Pull 10" CTC ADA	\$220.00	-	-	-	-
	1" Round Straight BTB Pull 12" CTC ADA	\$245.00	-			
99E	1" Round Offset Pull Handle, 10" CTC	\$320.00	-			

For Mounting Options, see Page 239

Options

CODE	DESCRIPTION	PULL ADJUSTMENT
AM*	Antimicrobial coating applied to tactile surfaces	\$30.00

*Notes: - - 6 piece minimum required. Can be a mix of different products. - Orders with less than 6 pieces need to be quoted and the list price add adjusted. - Allow 2-3 weeks for delivery.

MOUNTING OPTIONS: PULLS

LIST PRICE

Effective July 3, 2023

Thru Bolt

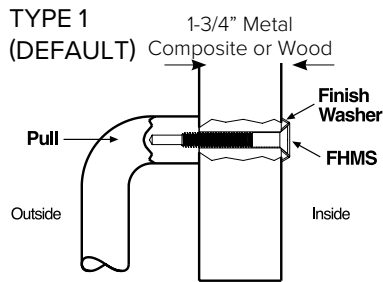

CODE	PULL ADJUSTMENT
1	N/C

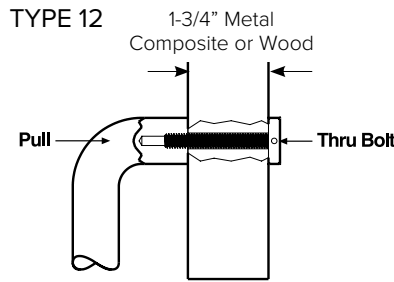

CODE	PULL ADJUSTMENT
12	\$27

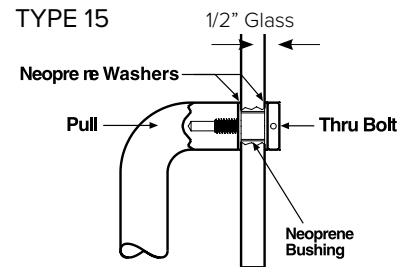

CODE	PULL ADJUSTMENT
15	\$27

Surface Concealed

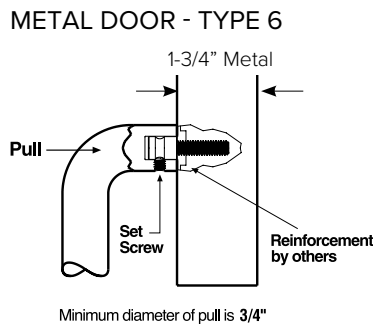

CODE	PULL ADJUSTMENT
6	\$16

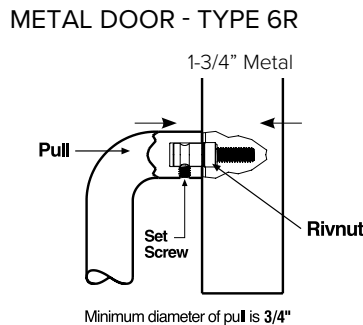

CODE	PULL ADJUSTMENT
6R	\$18

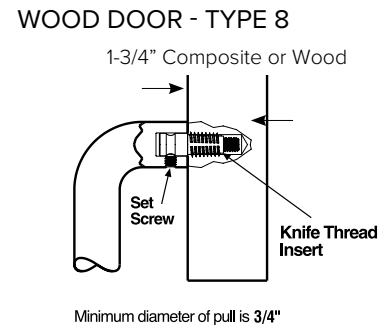

CODE	PULL ADJUSTMENT
8	\$18

Back to Back

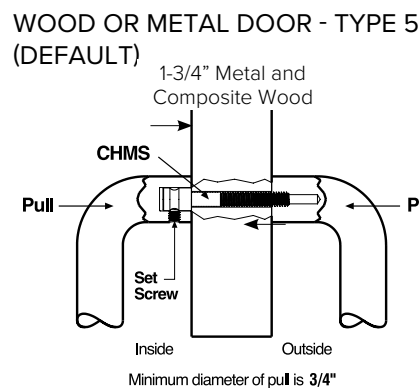

CODE	PULL ADJUSTMENT
5	N/C

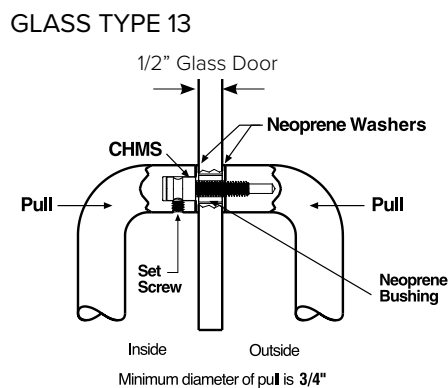

CODE	PULL ADJUSTMENT
15	\$13

MOUNTING OPTIONS: PULLS

LIST PRICE

Effective July 3, 2023

Pull Mounting Quick Reference Guide

PULL TYPE	DESCRIPTION	MOUNTING OPTIONS							
		HD*	1	5	6/6R	8	12	13	15
1B	5/8" Round Straight Pull 5-1/2" CTC		•				•		•
2C	3/4" Round Straight Pull 6" CTC		•		•	•	•		•
22C	3/4" Round Straight BTB Pull 6" CTC			•				•	
2D	3/4" Round Straight Pull 8" CTC		•		•	•	•		•
22D	3/4" Round Straight BTB Pull 8" CTC			•				•	
3D	1" Round Straight Pull 8" CTC	•	•		•	•	•		•
33D	1" Round Straight BTB Pull 8" CTC	•							
H3D	1" Round Straight Pull 8" CTC ADA	•	•		•	•	•		•
H33D	1" Round Straight BTB Pull 8" CTC ADA	•		•				•	
H3E	1" Round Straight Pull 10" CTC ADA	•	•		•	•	•		•
H33E	1" Round Straight BTB Pull 10" CTC ADA	•		•				•	
H3F	1" Round Straight Pull 12" CTC ADA	•	•		•	•	•		•
H33F	1" Round Straight BTB Pull 12" CTC ADA	•		•				•	
5C	1" 1/2 Round Straight Pull 6" CTC	•	•				•		
5D	1" 1/2 Round Straight Pull 8" CTC	•	•				•		
9E	1" Round Offset Pull Handle 10" CTC	•	•		•	•	•		•
99E	1" Round Offset Pull Handle BTB 10" CTC	•						•	
11	Cast Pull 5-1/2" CTC		•				•		

*HD Designation indicates 5/16" fasteners for 1 inch diameter pulls

PULL PLATES

LIST PRICE

Effective July 3, 2023



Specifications

PLATE SIZES:	• Varies by product, contact PDQ Customer Service for details.
PULL SERIES:	• Varies by product, see specific product details.
THICKNESS:	• 0.050"
PLATE MOUNTING FASTENERS:	• #6 X 5/8 CH PH SMS
FINISHES:	<ul style="list-style-type: none"> • 605 (US3) Bright Brass, 606 (US4) Satin Brass, 612 (US10) Satin Bronze, 613E Dark Oxidized Satin Bronze, 628 (US28) Aluminum - Anodized, 630 (US32D) Satin Stainless Steel • Antimicrobial Coating available on 630 (US32D) only





How to Order

QUANTITY	SERIES	PLATE	PULL	FINISH	PREP FOR LOCKING HARDWARE ^{1,2}	HANDING ¹	MOUNTING ³
10	86	3	2D	630	T	RH	1
<p>Ordering Examples: Standard mount for Metal Door: 86 3 2D 630 1</p> <p>Notes: 1 - Handing required for Plate Size 5, 6 2 - Cylinder and Thumbturn Prep not available in Plate Size 5 3 - For Mounting Options, see Page 239 4 - For Mounting Option List Price Adds, see Page 246</p>		<p>2 — 3-1/2" X 15"</p> <p>3 — 4" X 16"</p> <p>5 — 6" X 16" (630 ONLY)</p> <p>6 — 8" X 16" (630 ONLY)</p>	<p>1B — 5/8" Round Straight Pull 5-1/2" CTC</p> <p>2C — 3/4" Round Straight Pull 6" CTC</p> <p>2D — 3/4" Round Straight Pull 8" CTC</p> <p>3D — 1" Round Straight Pull 8" CTC</p> <p>H3D — 1" Round Straight Pull 8" CTC ADA</p> <p>H3E — 1" Round Straight Pull 10" CTC ADA</p> <p>H3F — 1" Round Straight Pull 12" CTC ADA</p> <p>5C — 1" Round Straight Pull 6" CTC</p> <p>5D — 1" Round Straight Pull 8" CTC</p> <p>11 — Cast Pull 5-1/2" CTC</p>	<p>605 — Bright Brass</p> <p>606 — Satin Brass</p> <p>612 — Satin Bronze</p> <p>613E — Dark Oxidized Satin Bronze</p> <p>628 — Satin Aluminum, Anodized</p> <p>630 — Satin Stainless Steel</p>	<p>C — Cylinder</p> <p>T — Thumbturn</p>	<p>RH — Right Hand</p> <p>LH — Left Hand</p>	<p>1 — TYPE 1 Thru Bolt for Metal, Composite or Wood Door (Default)</p> <p>6 — TYPE 6 Surface Concealed for Metal Door (Door Reinforcement by Others)</p> <p>6R —TYPE 6R Surface Concealed for Metal Door (Rivnut)</p> <p>8 — TYPE 8 Surface Concealed for Wood Door (Knife Thread Insert)</p> <p>12 — TYPE 12 Thru Bolt for Metal, Composite or Wood Door, Decorative Head</p>

PULLS AND PULL PLATES

LIST PRICE

Effective July 3, 2023

SERIES	PLATE	PULL	DESCRIPTION	LIST PRICE		
				630	605/606/612/613E	628
862		1B	5/8" Round Straight Pull 5-1/2" CTC	\$57.00	\$107.00	\$27.00
		2C	3/4" Round Straight Pull 6" CTC	\$65.00	\$115.00	\$35.00
		2D	3/4" Round Straight Pull 8" CTC	\$70.00	\$120.00	\$40.00
		3D	1" Round Straight Pull 8" CTC	\$105.00	\$155.00	\$75.00
		H3D	1" Round Straight Pull 8" CTC	\$113.00	\$163.00 (606/613E Only)	—
		5C	1" Flat 1/2 Round Straight Pull 6" CTC	\$97.00	\$147.00	\$67.00
		5D	1" Flat 1/2 Round Straight Pull 8" CTC	\$108.00	\$158.00	\$78.00
		11	Cast Pull 5-1/2" CTC	\$56.00	\$106.00	\$26.00
863		1B	5/8" Round Straight Pull 5-1/2" CTC	\$62.00	\$112.00	\$32.00
		2C	3/4" Round Straight Pull 6" CTC	\$70.00	\$120.00	\$40.00
		2D	3/4" Round Straight Pull 8" CTC	\$80.00	\$130.00	\$50.00
		3D	1" Round Straight Pull 8" CTC	\$114.00	\$164.00	\$84.00
		H3D	1" Round Straight Pull 8" CTC	\$122.00	\$172.00 (606/613E Only)	—
		H3E	1" Round Straight Pull 10" CTC ADA	\$140.00	—	—
		H3F	1" Round Straight Pull 12" CTC ADA	\$150.00	—	—
		5C	1" Flat 1/2 Round Straight Pull 6" CTC	\$104.00	\$154.00	\$74.00
		5D	1" Flat 1/2 Round Straight Pull 8" CTC	\$105.00	\$155.00	\$75.00
		11	Cast Pull 5-1/2" CTC	\$70.00	\$120.00	\$40.00
865		1B	5/8" Round Straight Pull 5-1/2" CTC	—	—	—
		2C	3/4" Round Straight Pull 6" CTC	\$77.00	—	—
		2D	3/4" Round Straight Pull 8" CTC	\$89.00	—	—
		3D	1" Round Straight Pull 8" CTC	\$120.00	—	—
		H3D	1" Round Straight Pull 8" CTC	\$130.00	—	—
		H3E	1" Round Straight Pull 10" CTC ADA	\$146.00	—	—
		H3F	1" Round Straight Pull 12" CTC ADA	\$157.00	—	—
		5C	1" Flat 1/2 Round Straight Pull 6" CTC	\$109.00	—	—
		5D	1" Flat 1/2 Round Straight Pull 8" CTC	\$120.00	—	—
		11	Cast Pull 5-1/2" CTC	\$74.00	—	—
866		2D	3/4" Round Straight Pull 8" CTC	\$98.00	—	—
		3D	1" Round Straight Pull 8" CTC	\$125.00	—	—
		H3D	1" Round Straight Pull 8" CTC	\$135.00	—	—
		H3E	1" Round Straight Pull 10" CTC ADA	\$154.00	—	—
		H3F	1" Round Straight Pull 12" CTC ADA	\$165.00	—	—
		5C	1" Flat 1/2 Round Straight Pull 6" CTC	\$114.00	—	—
		5D	1" Flat 1/2 Round Straight Pull 8" CTC	\$125.00	—	—

For Mounting Options, see Page 239.

Options – Locking Hardware Prep

CODE	DESCRIPTION	PULL PLATE ADJUSTMENT
T	Locking Hardware – Thumbturn Prep	\$8.00
C	Locking Hardware – Cylinder Prep	
AM*	Antimicrobial protected coating applied to tactile surfaces	\$30.00

Note: 630 finish only, please place antimicrobial coated orders separately, and allow 30 days for manufacturing.

For additional product finishes or styles, please contact PDQ Technical Service.



Push and Push-Pull Bars



91 00 33 Series Push Bar





How to Order

QUANTITY	SERIES	PULL	PUSH BAR	FINISH	MOUNTING OPTIONS, PUSH BAR ONLY	MOUNTING OPTIONS, OFFSET PULL AND PUSH BAR SET
10	91	9E	33	630	—	S
Ordering Examples: Push Bar Only, Thru Bolt Mounting: 91 00 33 630 1HD Offset Pull Handle Push-Bar Set, Standard Mounting: 91 9E 33 630 S		00 — No Pull 3D — 1" Round Straight Pull 8" CTC H3D — 1" Round Straight Pull 8" CTC ADA H3E — 1" Round Straight Pull 10" CTC ADA H3FÆ — 1" Round Straight Pull 12" CTC ADA 9E — 1" Round Offset Pull Handle	XX — 1" Round Push Bar, Xx" CTC Example: 33 — 1" Round Push Bar, 33" CTC	630 — Satin Stainless Steel 630AM — Satin Stainless Steel With Antimicrobial	1 — Type 1 (Default) Thru Bolt For Metal, Composite Or Wood Door 6 — Type 6 Surface Concealed For Metal Door (Door Reinforcement By Others) 6R — Type 6R Surface Concealed For Metal Door (Rivnut) 8 — Type 8 Surface Concealed For Wood Door (Knife Thread Insert) 12 — Type 12 Thru Bolt For Metal, Composite Or Wood Door 15 — Type 15 Thru Bolt For Glass Door, Decorative Head	S — Standard (Default) D — Decorative M — Concealed For Metal Doors W — Concealed For Composite Or Wood Doors G — Decorative For Glass Doors
SEE PAGE 245 FOR MOUNTING OPTION PRICING						

Push Bars

MODEL	DESCRIPTION	LIST PRICE 630	PUSH BAR ADJUSTMENT
 91 00 33	1" Round Push Bar, Including 33" CTC	\$320.00	—
	1" Round Push Bar, Over 33" CTC		\$15.00 per inch
 91 91 33	1" Round Push Bar BTB	\$645.00	\$30.00 per inch

Push-Pull Bars

MODEL	DESCRIPTION	LIST PRICE 630
 3D	1" Round Straight Pull 8" CTC	\$105.00
 H3D H3E H3F	1" Round Straight Pull 8" CTC ADA	\$115.00
	1" Round Straight Pull 10" CTC ADA	\$125.00
	1" Round Straight Pull 12" CTC ADA	\$135.00
9E	1" Round Offset Pull, 10" CTC ADA	\$205.00

For Mounting Options, see Page 245

PUSH AND PUSH-PULL BARS

LIST PRICE

Effective July 3, 2023

Free End Details

Thru Bolt

TYPE 1

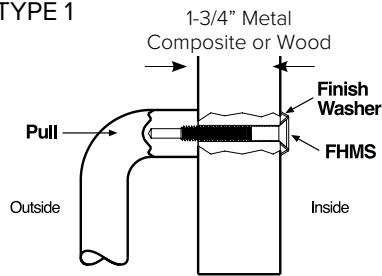

TYPE 12

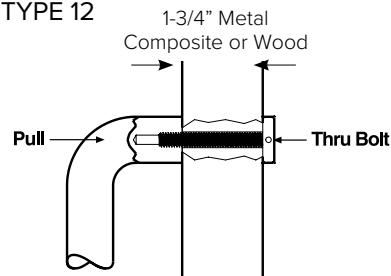

TYPE 15

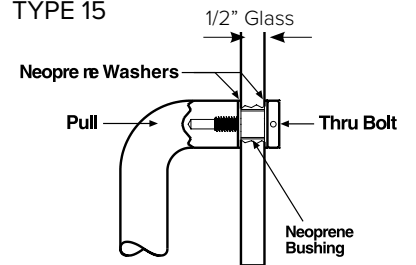

Surface Concealed

TYPE 6

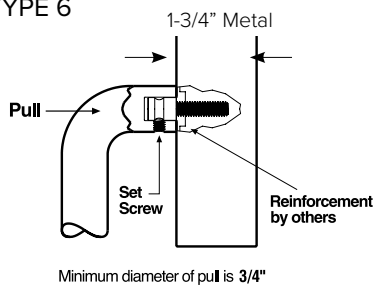

TYPE 6R

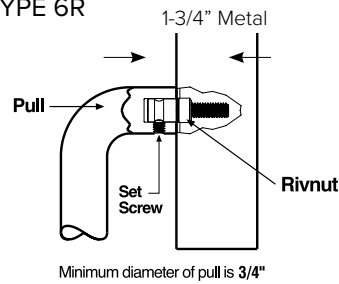

TYPE 8

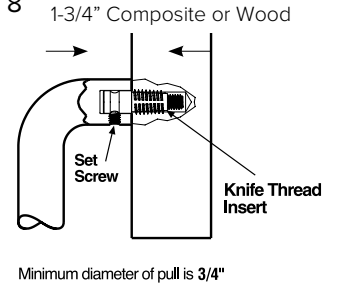

Common End Details

TYPE 5

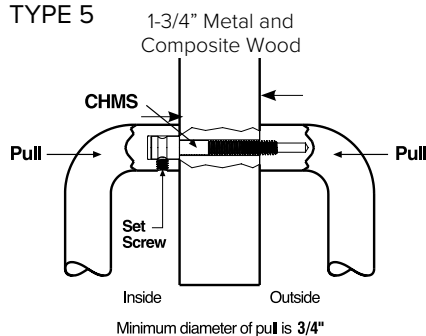

TYPE 13

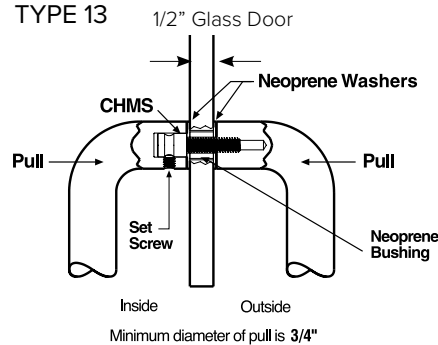

Note: For measurement details see brochure

Options – Mounting for Offset Pull Handles – Push Bar Sets

TYPE	DESCRIPTION	MOUNTING TYPES		ADJUSTMENT
		COMMON END	FREE END	
S	Std Thru Bolt For 1-3/4" Metal, Composite or Wood Doors (Default)	5	1	N/C
D	Decorative Thru Bolt for 1-3/4" Metal, Composite or Wood Doors	5	12	\$30.00
M	Concealed for 1-3/4" Metal Doors	5	6	\$25.00
W	Concealed for 1-3/4" Composite or Wood Doors	5	8	\$30.00
G	Decorative Thru Bolt for 1/2" Glass Doors	13	15	\$25.00

Screw Types

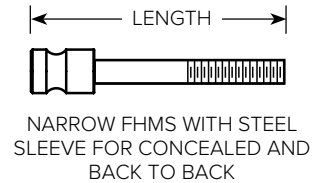
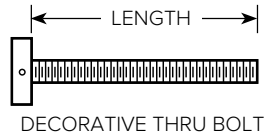
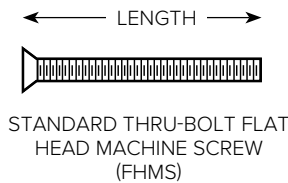

Fasteners for Door Pulls

Note: Fastener packs for 1-3/4" Steel and Composite Wood or 1/2" Thick Glass Doors. For other door thickness applications, contact PDQ Technical Service.

PART NUMBER (Specify Finish)	OPTIONS, MOUNTING TYPE	DESCRIPTION	LIST PRICE 605, 613E, 630
9001	1	2 ea. 1/4-20 x 2-1/4" FH MS, 2 ea. 1/4" Finish Washers.	\$8.00
	HD	2 ea. 5/16-18 x 2-1/4 FH MS, 2 ea. 5/16" Finish Washers.	
9005	5W	2 ea. 1/4-20 x 2-3/4" Undersize Head FH MS, 2 ea. 1/4-20 x 3/16" Set Screws, 2 ea. 1/4" x 1/2" Tapered Steel Sleeves, 2 ea. 1/4-20 x 1/2" Threaded Insert.	\$24.00
	HD	2 ea. 5/16-18 x 2-3/4" Undersize Head FH MS, 2 ea. 1/4-20 x 1/4" Set Screws, 2 ea. 5/16" x 1/2" Steel Sleeves, 2 ea. 1/4-20 x 1/2" Threaded Insert.	
9006	6	2 ea. 1/4-20 x 1" Undersize Head FH MS, 2 ea. 2 ea. 1/4-20 x 3/16" Set Screws, 2 ea. 1/4" x 1/2" Tapered Steel Sleeves.	
	HD	2 ea. 5/16-18 x 1" Undersize Head FH MS, 2 ea. 1/4-20 x 1/4" Set Screws, 2 ea. 5/16" x 1/2" Tapered Steel Sleeves.	
9006R	6R	2 ea. 1/4-20 x 1-3/4" Undersize Head FH MS, 2 ea. 1/4-20 x 3/16" Set Screws, 2 ea. 1/4" x 1/2" Tapered Steel Sleeves, 2 ea. 1/4-20 Rivnut Inserts.	
	HD	2 ea. 5/16-18 x 1-5/8 Undersize Head FH MS, 2 ea. 1/4-20 x 1/4" Set Screws, 2 ea. 5/16" x 1/2" Tapered Steel Sleeves, 2 ea. 5/16-18 Rivnut Inserts	
9008	8	2 ea. 1/4-20 x 1-5/8" Undersize Head FH MS, 2 ea. 1/4-20 x 3/16" Set Screws, 2 ea. 1/4" x 1/2" Tapered Steel Sleeves, 2 ea. 1/4 - 20 Knife Thread Inserts	
	HD	2 ea. 5/16-18 x 1-5/8 Undersize Head FH MS, 2 ea. 1/4-20 x 3/16" Set Screws, 2 ea. 5/16" x 1/2" Tapered Steel Sleeves, 2 ea. 5/16 - 18 Knife Thread Inserts.	
9012	12	2 ea. 1" DIA Head, 1/4-20 x 2-1/4" Decorative Cap Bolts.	\$34.00
	HD	2 ea. 1" DIA Head, 5/16-18 x 2-1/4" Decorative Cap Bolts.	
9013	13	2 ea. 1/4-20 x 1-3/4" Undersize Head FH MS, 2 ea. 1/4-20 x 3/16" Set Screws, 2 ea. 1/4" x 1/2" Tapered Steel Sleeves, 2 ea. Bushings for 1/2" Thick Glass Door, 4 ea. Neoprene Washer.	\$38.00
	HD	2 ea. 5/16-18 x 1-3/4" Undersize Head FH MS, 4 ea. 1/4-20 x 1/4" Set Screws, 2 ea. 5/16" x 1/2" Tapered Steel Sleeves, 2 ea. Bushings for 1/2" Thick Glass Door, 4 ea. Neoprene Washers.	
9015	15	2 ea. 1" DIA Head 1/4-20 x 1-1/8" Decorative Cap Bolts, 2 ea. Neoprene Bushings for 1/2" Thick Glass Door, 4 ea. Neoprene Washers.	\$55.00
	HD	2 ea. 1" DIA Head 1/4-20 x 1-1/8 Decorative Cap Bolts, 2 ea. Neoprene Bushings for 1/2" Thick Glass Door, 4 ea. Neoprene Washers.	

Ordering example: 9001 HD-630. . HD is for 1" pulls

Types

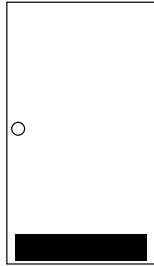

MOP PLATE
UP TO 6" H
X 48" W

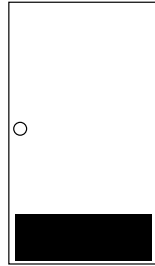

KICK PLATE
6" TO 12" H
X 48" W

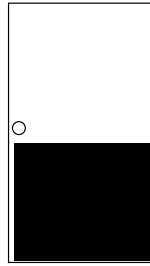

ARMOR PLATE
UP TO 48" H
X 48" W AND
AVAILABLE IN
MOST FINISHES

Features

- All PDQ door protection plates receive a light bevel in a secondary process to ensure a smooth edge.
- Provides protection for the bottom of the door from scuffing due to the foot traffic or cleaning maintenance.
- Recommended for all doors especially when using a door closer.
- Standard oval head undercut screws create a countersunk appearance.

Specifications

MATERIAL:	• Stainless Steel
THICKNESS:	• 0.050"
MOUNTING FASTENERS:	• #6 x 5/8 OH PH SMS
FINISHES:	• 630 (US32D) Satin Stainless Steel, 613E , 622(US19)

How to Order

QUANTITY	SERIES	HEIGHT	WIDTH	FINISH
10		06	34	630
Ordering Example:		EXAMPLES: 06 — 6" 10 — 10"	EXAMPLES: 34 — 34" 35 — 35"	613E — Bronze 622 — Flat Black 630 — Satin Stainless Steel

Mop, Kick, and Armor Plates

DIMENSIONS	630	613E/622
6" x 34"	\$75.00	\$94.00
8" x 34"	\$111.00	\$139.00
10" x 34"	\$133.00	\$166.00
12" x 34"	\$152.00	\$190.00
32" x 34"	\$462.00	\$578.00
34" x 34"	\$490.00	\$613E.00
36" x 34"	\$550.00	\$688.00
6" x 35"	\$88.00	\$110.00
8" x 35"	\$115.00	\$144.00
10" x 35"	\$139.00	\$174.00
12" x 35"	\$172.00	\$215.00
32" x 35"	\$473.00	\$591.00
34" x 35"	\$520.00	\$650.00
36" x 35"	\$578.00	\$723.00



**Wall Stops
and Holders**



**Floor Stops
and Holders**



**Kick Down Door
Stops**



Hinge Stops



Roller Stops

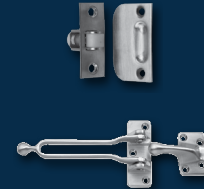





**Roller Latches,
Catches and
Protectors**



**Hooks, Silencers,
Door Viewers and
Strikes**





Wall Stops and Holders

MODEL (SPECIFY FUNCTION)	DESCRIPTION	QTY PER BOX	LIST PRICE					
			605	613E	619	625	626	630
 101	Wall Stop - Convex Bumper ANSI Type L02101	50	\$8.00					
 102	Wall Stop - Concave Bumper ANSI Type L02251	50						
 106	Wall Stop - Adhesive Backed	50	\$3.00					
 107	Door Stop - Heavy Duty ANSI Type L02021	5	\$32.00	—	—	\$32.00	—	
 108	Door Stop - Heavy Duty with Keeper ANSI Type L01351	5	\$42.00	—	—	\$42.00	—	
 109	Door Stop ANSI Type L02031	5	\$13.00	—	—	—	\$13.00	
 110	Door Stop - Aluminum ANSI Type L02031	15	\$8.00					—
 112	Door Stop - Spring Base ANSI Type L02051	100	\$3.00			—	—	—
 115	Angled Wall Stop ANSI Type L02051	20	—	—	—	—	\$55.00	
 119	Door Holder with Stop	20	—	—	—	—	\$80.00	

Floor Stops and Holders

MODEL (SPECIFY FUNCTION)	DESCRIPTION	QTY PER BOX	LIST PRICE			
			605	613E	625	626
 220	Universal Dome Stop ANSI Type L02141 for plastic anchors ANSI Type L20161 for lead anchors	20	—	—	—	\$15.00
 221	Floor Stop - Low Dome ANSI Type L02141	50	\$12.00			
 222	Floor Stop - High Dome ANSI Type L02061	50	\$14.00			
 223	Floor Stop - Riser ANSI Type L02141	50	—	—	—	\$6.00
 224	Floor Stop - Offset ANSI Type L02181	10	—	\$28.00	—	\$28.00
 225	Floor Stop - Offset ANSI Type L02181	10	—	\$32.00	—	\$32.00
 226	Floor Stop - Offset with Hold Open ANSI Type L01371	5	—			
 227	Floor Stop ANSI Type L02131	5	\$34.00		—	\$34.00
 228	Floor Stop - with Keeper ANSI Type L01371	5	\$36.00		—	\$36.00
 229	Stop ANSI Type L02131	10				
 230	Stop ANSI Type L02131	10				
 231	Floor Stop, Low Profile	25	\$18.00		—	\$18.00
 232	Floor Stop	25	\$20.00		—	\$20.00
 233	Floor Stop ANSI Type L02131	10	—	—	—	



Kick Down Door Stops

MODEL (SPECIFY FINISH)	DESCRIPTION	QTY PER BOX	LIST PRICE				
			605	613E	626	689	695
 240	Kick Down - 4" ANSI Type L01382	10	—	—	—	\$18.00	
 241	Kick Down - 5" ANSI Type L01382	10	—	—	—	\$20.00	
 242	Kick Down - 4" ANSI Type L01382	10	\$24.00			—	—
 243	Kick Down - 5" ANSI Type L01382	10	\$32.00			—	—

Hinge Stops

MODEL (SPECIFY FINISH)	DESCRIPTION	QTY PER BOX	LIST PRICE				
			605	613E	626	689	695
 245	Hinge Stop - 5" ANSI Type L02223	100	\$6.00			—	—



Roller Stops

MODEL (SPECIFY FINISH)	DESCRIPTION	QTY PER BOX	LIST PRICE				
			605	613E	626	689	695
 350	Roller Stop, 4-1/2" ANSI Type L02191	10	\$26.00			—	—
 351	Roller Stop, 6-1/2" ANSI Type L02201	10	\$38.00			—	—
 352	Roller Stop, Curved ANSI Type L02211	10	\$40.00			—	—



Roller Latches, Catches and Protectors

MODEL (SPECIFY FINISH)	DESCRIPTION	QTY PER BOX	LIST PRICE				
			605	613E	626	689	695
 571	Roller Latch with T Strike ANSI Type E09101	5	\$32.00			—	—
 572	Roller Latch with ASA Strike	5	\$36.00			—	—
 573	Roller Latch with Full Lip Strike	5				—	—
 574	Roller Latch with Angle Stop ANSI Type E09111	10	—	—	\$64.00	—	—
 575	Roller Latch with Strike	10	\$16.00			—	—
 577	Ball Catch Adjustable	10				—	—
 578	Door Guard	10	\$38.00			—	—
 579	Privacy Door Latch	10	—	\$58.00		—	—
 582	Latch Protector	20	—	—	—	\$17.00	
 583	Latch Protector with 3-3/8" DIA Notched	20	—	—	—		
 584	12" Interlock Latch Protector	20	—	—	—	\$14.00	

Hooks

MODEL (SPECIFY FINISH)	DESCRIPTION	QTY PER BOX	FINISH N/A	LIST PRICE			
				605	613E	625	626
 901	Coat Hook - Medium ANSI Type L03111	10	—	—	—	—	\$14.00
 902	Wardrobe Hook - Small ANSI Type L03111	10	—	—	—	—	



Silencers

MODEL	DESCRIPTION	QTY PER BOX	LIST PRICE
 904	Silencer - Metal Doors (Must be ordered in multiples of 100.) ANSI Type L03011	100	\$18.00
 905	Silencer - Wood Doors (Must be ordered in multiples of 100.) ANSI Type L03021	100	

Door Viewers

MODEL (SPECIFY FINISH)	DESCRIPTION	QTY PER BOX	FINISH N/A	LIST PRICE		
				605	613E	626
 906	Door Viewer - 160 degrees UL ANSI Type 03222	25	—	\$16.00		

Strikes

MODEL (SPECIFY FINISH)	DESCRIPTION	QTY PER BOX	FINISH N/A	LIST PRICE			
				605	613E	625	626
 909	Dust Proof Strike (Specify Finish), 1 each	—	—	\$42.00	—	—	\$42.00
 95572	Strike, Roller Latch - ASA	25	—	\$16.00	—	—	\$16.00
 95673	Strike, Roller Latch - Full Lip	50	—		—	—	



Sliding Barn Door Hardware



Architecturally Designed for Hospitality, Multi-Family and Commercial Applications.

Features

- Exclusive Soft Close stop design. Specify option SC.
- Max door weight: 220 lbs
- Nylon coated rollers
- Grade 304 Stainless Steel components
- Finish: 630 satin stainless steel



Specifications

CONFIGURATIONS:	<ul style="list-style-type: none"> • Single • Bi-parting
INSTALLATION:	<ul style="list-style-type: none"> • Side Wall Mount (only)
PERFORMANCE:	<ul style="list-style-type: none"> • Meets ANSI 156.14 Grade 1 Standard (100,000 cycles)
STANDARD KIT INCLUDES:	<ul style="list-style-type: none"> • 1 ea Track (specify length) • 2 ea Wall Brackets • 2 ea Track Stops • 2 ea Top Mount Hangers with Anti-jump pins • 1 ea Wood Guide • Installation fasteners

Cross Reference

PDQ	HAFELE	HAGER	PEMKO
STS SERIES	FLATEC II SERIES	9432 SERIES	W60 SERIES
STS WITH SOFT CLOSE	N/A	N/A	W60 WITH CUSHION STOP



SLIDING BARN DOOR HARDWARE — LIST PRICE

Effective July 3, 2023

How to Order

QUANTITY	SERIES	DOOR MATERIAL	HANGER TYPE	TRACK (SPECIFY LENGTH)	FINISH	OPTIONS
10	STS	W	171	78	630	—
	STS — SLIDING TRACK SYSTEM	W — WOOD	171 — TOP MOUNT, SINGLE ROLLER	78 — 78-3/4" FOR 36" WIDE DOOR 98 — 98-7/16 " FOR 48" WIDE DOOR	630 — SATIN STAINLESS STEEL	SC — SOFT CLOSE







Ordering Examples: Kit for Wood Door: STS W 171 78 630 / Kit for Wood Door with Soft Close: STS W 171 78 630 SC

MODEL	DESCRIPTION	LIST PRICE
STS W 171 78 630	Sliding Barn Door Hardware for 36" Wood Door,	\$615.00
STS W 171 98 630	Sliding Barn Door Hardware for 48" Wood Door,	\$690.00

Options

CODE	DESCRIPTION	HARDWARE ADJUSTMENT
STS-W-171-78-630-SC	Soft Close (Extended lead time: Consult factory for lead times)	\$150.00
STS-W-171-98-630-SC	Soft Close (Extended lead time: Consult factory for lead times)	

Accessories

PART NUMBER	DESCRIPTION	LIST PRICE
STSP17101-630 	STOP	\$22.00 each
STSP17103-630 	TOP MOUNT ROLLER HANGER. INCLUDES INSTALLATION FASTENERS.	\$90.00 each
STSP17104-630 	SOFT CLOSE ASSEMBLY	\$46.00 each
STSP17105-630 	SOFT CLOSE TRIGGER BRACKET. INCLUDES INSTALLATION FASTENERS.	\$18.00 each
STSP17106-630 	FLOOR GUIDE. INCLUDES INSTALLATION FASTENERS.	
STSP17107-630 	BI-PARTING CONNECTOR MATERIAL: GRADE 304 STAINLESS STEEL FINISH: 630 STAINLESS STEEL. MATCHES RAIL FINISH. "O" RINGS MAKE FOR EASY INSERTION INTO TRACK AND HELPS DAMPEN UNWANTED VIBRATION NOISE.	\$35.00 each

Bi-Parting Solutions

FOR OPENINGS UP TO 4 FT WIDE:

- Requires: — 1ea STS Series Track Assy
- 2ea STSP17103-630 Roller Assemblies
- 2ea STSP7101-630 Stops
- 1ea STSP17106-630 Floor Guide

FOR OPENINGS OVER 4 FT WIDE:

- Requires: — 2ea STS Series Track Assys (specify size)
- 1ea STSP17107-630 Bi-parting Connector



BI-PARTING CONNECTOR

Note: Refer to Installation Instructions

Note: Refer to Installation Instructions

Master Key System Design

2- Levels of keying

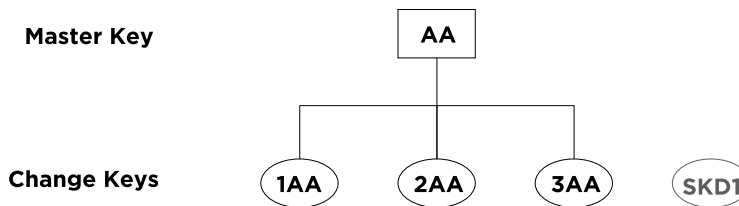

3- Levels of keying

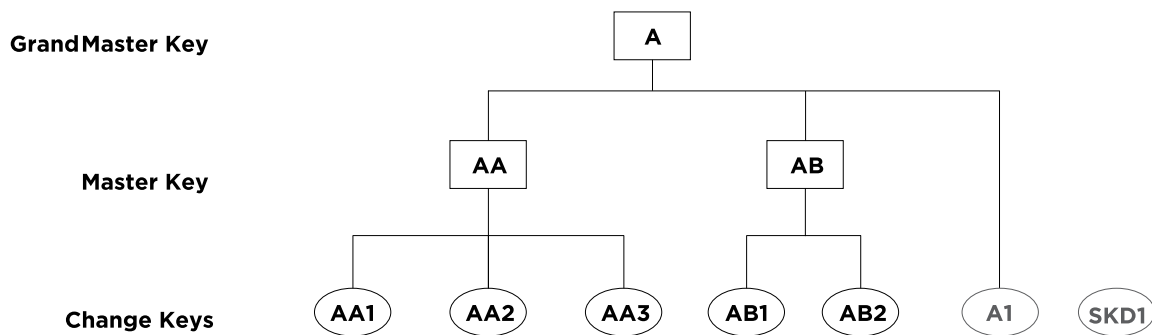

4- Levels of keying

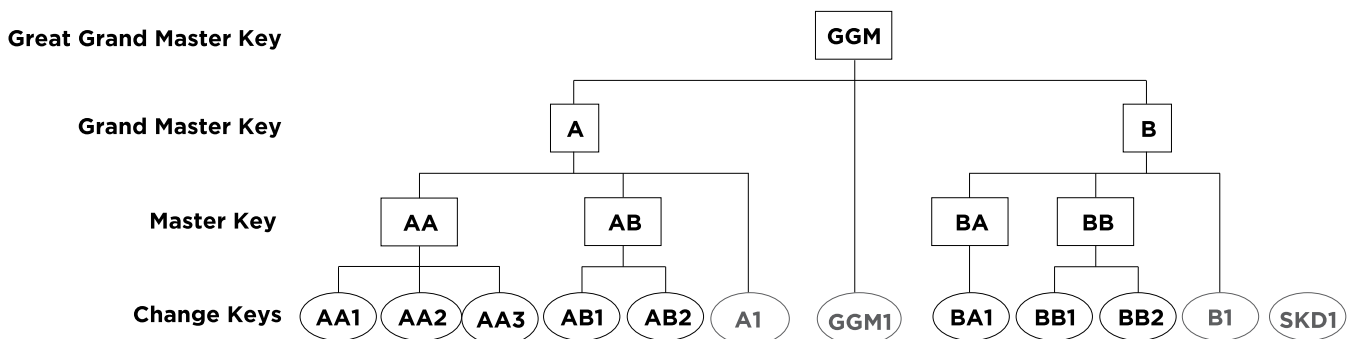



Keying System Worksheet



Job Reference _____
 Information _____
 Date _____ By _____
 Approved By _____
 Date _____

Grand Master Key
Area/Dept

Instructions: Indicate the highest level master key symbol in the top line of each box. Identify the area or department, indicate the total number of key changes, including future expansion. Do not use letters I, O, or Q in key symbols.

Page of

Selective _____ Control Key Used with IC cores only
 Master Key _____ CMK Construction Master Keying

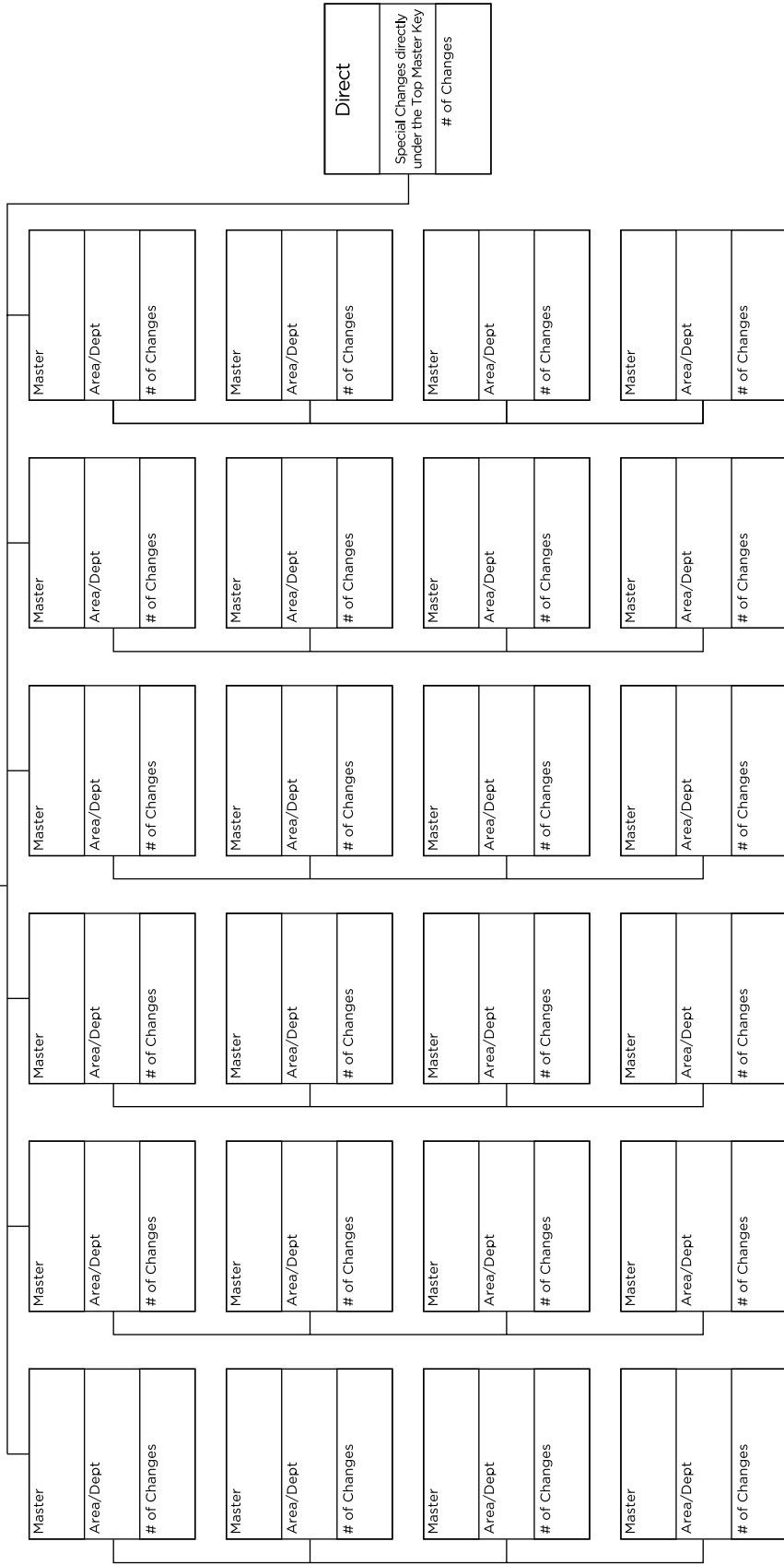

Single Keyed Changes

SKD
Door# or Area

SKD
Door# or Area

SKD
Door# or Area

Special Instructions

Change key only, will not be operated by any other key within the system

Finishes

PDQ Manufacturing finishes are durable, top-quality finishes obtained by the processing of solid brass, bronze, stainless steel and other materials. It is important that usage, climate and other conditions be taken into consideration when selecting finishes. This is especially true in areas subjected to corrosive vapors, humid climate or sea air, which in short time may have a damaging effect on finishes. To preserve appearance, cleaning and care may be required. Non-clear coated finishes should not be cleaned with soap or solvents; organically coated surfaces should be cleaned periodically with mild, non-abrasive soap and buffed lightly with a clean cloth. Contact PDQ technical service for recommendations on the care of finished hardware.

BHMA symbols and U.S. Code Designations (noted below in parentheses) are used in some cases to indicate the similarity of finish appearance, regardless of the base material.

PDQ strives to stock all finishes shown in this price book for immediate shipment (1-2 days, less keying). However, we suggest you contact the factory to confirm availability for large jobs.

Refer to Each Lock Series Section for Standard Finish Availability.

Architectural



605 (US3)
Bright Brass



606 (US4)
Satin Brass



612 (US10)
Satin Bronze



613E
Dark Oxidized Satin
Bronze



619 (US15)
Satin Nickel

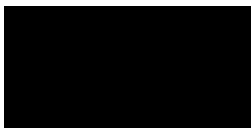

622 (US19)
Flat Black



625 (US26)
Bright Chromium



626 (US26D)
Satin Chromium



629 (US32)
Bright Stainless Steel



630 (US32D)
Satin Stainless Steel



652 (US26D)
Satin Chromium

Painted



689 (US28)
Aluminum



693
Black



695
Dark Duranodic
Bronze



696 (US4)
Satin Brass (Gold)

Finishes shown are representative only. PDQ cannot guarantee that product shipped will match finishes shown.
Not all products are available in all finishes listed.

Lock Handing

What is Lock Handing?

The handing of a lock is important in order to ensure that the correct side of the door is secure, the levers are oriented properly, and that the door closes properly.

There are 2 parts to a door and lock handing, the handing (left or right) and the swing of the door (whether it is reversed or standard). There are 4 different lock handings; left hand (LH), right hand (RH), left-hand reverse (LHR), and right-hand reverse (RHR).

There are many ways to determine handing however PDQ recommends the following method:

- Stand on the outside (secure side) of the door
- Note the location of the hinges, not the lock
- If the hinges are on the left, it's a left-hand door
- If the hinges are on the right, it's a right-hand door
- Next note if the door swings toward you or away from you
- If the door swings away from you, it's a standard swing door
- If the door swings towards you, it's a reverse bevel door

See the illustration below for examples of how to determine the door handing you need when placing your PDQ order.

How to Determine Hand of Door

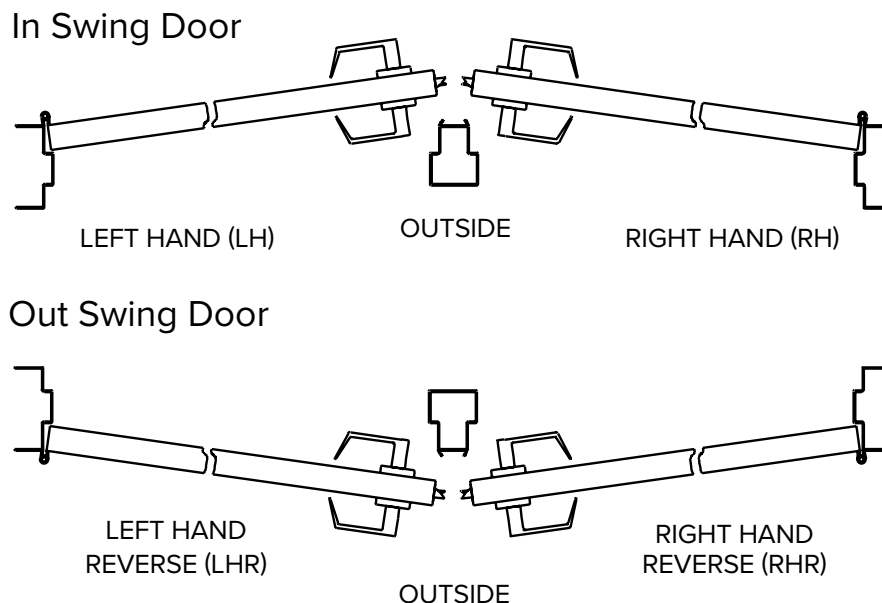

Weight Chart

Locksets*			
<i>Item</i>	<i>Function</i>	<i>Case Quantity</i>	<i>Average Weight/Case (lbs.)**</i>
<i>MR (Rose)</i>	<i>Entrance</i>	<i>6</i>	<i>45</i>
<i>MR (Escutcheon)</i>	<i>Entrance</i>	<i>6</i>	<i>46</i>
<i>XGT</i>	<i>Entrance</i>	<i>6</i>	<i>33</i>
<i>GT</i>	<i>Entrance</i>	<i>6</i>	<i>33</i>
<i>GP</i>	<i>Entrance</i>	<i>6</i>	<i>30</i>
<i>SD</i>	<i>Entrance</i>	<i>10</i>	<i>37</i>
<i>SX Ball</i>	<i>Entrance</i>	<i>10</i>	<i>32</i>
<i>SV Ball</i>	<i>Entrance</i>	<i>20</i>	<i>43</i>
<i>CL</i>	<i>Entrance</i>	<i>6</i>	<i>31</i>
Deadbolts			
<i>Item</i>	<i>Function</i>	<i>Case Quantity</i>	<i>Average Weight/Case (lbs.)**</i>
<i>KT Single Cylinder</i>	<i>116</i>	<i>10</i>	<i>19</i>
<i>KT Double Cylinder</i>	<i>137</i>	<i>10</i>	<i>22</i>
<i>KM Single Cylinder</i>	<i>116</i>	<i>20</i>	<i>41</i>
<i>KM Double Cylinder</i>	<i>137</i>	<i>20</i>	<i>54</i>
<i>KV Single Cylinder</i>	<i>116</i>	<i>20</i>	<i>26</i>
<i>KV Double Cylinder</i>	<i>137</i>	<i>20</i>	<i>35</i>
Closers			
<i>Item</i>	<i>Application</i>	<i>Case Quantity</i>	<i>Average Weight/Case (lbs.)**</i>
<i>3100</i>	<i>Tri-Pack</i>	<i>10</i>	<i>61</i>
<i>5100</i>	<i>Tri-Pack</i>	<i>6</i>	<i>48</i>
<i>5300</i>	<i>Tri-Pack</i>	<i>6</i>	<i>41</i>
<i>5500</i>	<i>Tri-Pack</i>	<i>6</i>	<i>41</i>
<i>7100</i>	<i>Tri-Pack</i>	<i>4</i>	<i>50</i>
Exit Devices			
<i>Item</i>	<i>Application</i>	<i>Case Quantity</i>	<i>Average Weight/Case (lbs.)**</i>
<i>4200R 3'</i>	<i>Rim</i>	<i>4</i>	<i>43</i>
<i>4200V 3'</i>	<i>Surface Vertical</i>	<i>4</i>	<i>61</i>
<i>4200RA 4'</i>	<i>Rim</i>	<i>4</i>	<i>45</i>
<i>4200VA 4'</i>	<i>Surface Vertical</i>	<i>4</i>	<i>67</i>
<i>6300R 3'/6320R 2'</i>	<i>Rim</i>	<i>4</i>	<i>60</i>
<i>6310R 4'</i>	<i>Rim</i>	<i>4</i>	<i>68</i>
<i>6300V 3'/6320V 2'</i>	<i>Surface Vertical</i>	<i>4</i>	<i>70</i>
<i>6310V 4'</i>	<i>Surface Vertical</i>	<i>4</i>	<i>78</i>
<i>6300C 3'/6320C 2'</i>	<i>Concealed Vertical</i>	<i>4</i>	<i>68</i>
<i>6310C 4'</i>	<i>Concealed Vertical</i>	<i>4</i>	<i>72</i>
<i>6300M 3'/6320M 2'</i>	<i>Mortise</i>	<i>4</i>	<i>68</i>
<i>6310M 4'</i>	<i>Mortise</i>	<i>4</i>	<i>72</i>
<i>6300D 3'</i>	<i>Dummy</i>	<i>4</i>	<i>44</i>
<i>6310D 4'</i>	<i>Dummy</i>	<i>4</i>	<i>46</i>
<i>6320D 2'</i>	<i>Dummy</i>	<i>4</i>	<i>42</i>
<i>6400R 3'/6420R 2'</i>	<i>Rim</i>	<i>4</i>	<i>58</i>
<i>6410R 4'</i>	<i>Rim</i>	<i>4</i>	<i>68</i>
<i>6400V 3'/6420V 2'</i>	<i>Surface Vertical</i>	<i>4</i>	<i>70</i>
<i>6410V 4'</i>	<i>Surface Vertical</i>	<i>4</i>	<i>74</i>
<i>6400C 3'/6420C 2'</i>	<i>Concealed Vertical</i>	<i>4</i>	<i>68</i>
<i>6410C 4'</i>	<i>Concealed Vertical</i>	<i>4</i>	<i>72</i>

*Data is with PHL lever unless otherwise noted. **Add approximately 2 lbs. for fire rated device.

SECURING CONFIDENCE **OPENING** **POSSIBILITIES**



Phone: 717.656.4281
Tech Support: 833.273.7832



Headquarters:
2230 Embassy Drive,
Lancaster, PA 17603

P.O. Box 6426
Lancaster, PA 17607



Email: help@pdqlocks.com



Regional Distribution Centers:
Lancaster, PA | Norcross, GA |
Auburn, WA