

TABLE OF CONTENTS

	A			M
ANSI Standards.....		2	Mortar Box.....	11
	B			P
Bearing at Top		12	Painted Cover Channels.....	6
Bearing Replacement Kit.....		14	Polished Cover Channels.....	6
	C			Q
Cancellation Notification		2	Quick Connect.....	9
Center Punches		14		R
Concealed Electric Hinges with Lead Wire.....		7-10	Replacement Moldings	11
Concealed Electric Monitoring (EMN).....		7-10		S
Concealed Electric Through-Wire (ETW).....		7-10	Shim Stock.....	15
Concealed Electric Through-Wire - Removable (RETW)		7-10	Shipping Cartons	15
Concealed Electric Through-Wire and Monitoring (ETM)		7-10	Short Hinges.....	12
Custom Hole Pattern		12	Special Anodizing	6
	D		Special Cover Channels	5
Dutch Door Prep		14	Special Finished Hinges.....	6
	E		Special Holes	6
Electric Power Transfer Preparation (EPT).....		9	Special Lengths	3
Electrical Modifications		7-10	Special Products.....	3
Exposed Electric Contacts (E).....		7-10	Standard Finishes.....	3
Exposed Electric Switches (EIS).....		7-10	Standard Lengths.....	3
Extra Long Hinges.....		12		T
Power Transfer Preparation.....		9	Tamper Resistant Hinge.....	14
	F		Template Hinges.....	3
Fasteners.....		15	TIPIT®	13-14
Field Modifications.....		3		
Fire Ratings		4		
	H			
Hinges				
Concealed.....		16, 17, 19-22, 26-27, 29		
Full Surface.....		16, 19, 23-25, 28		
Half Surface		17-19, 23-25, 28		
Hospital Tip.....		13		
How To Order		2		
	L			
Length Specifications.....		3		



Roton Continuous Hinges

HOW TO ORDER:

Example: 780-112HDFFUL 119" CLR 1 PK

Stock Number: 184038

Item Number: YS 1121190CLR000001 Rev. S

780

ROTON
ALUMINUM
CONTINUOUS
GEARED
HINGE

112HD

ITEM#

119"

LENGTH

CLR

FINISH

1 PK

STANDARD
SINGLE
PACK

INTRODUCTION

Hager Roton hinges are unique, aluminum geared hinges developed to outperform most other entrance components because the weight of the door is distributed along the full length of the door frame.

Roton continuous hinges have been utilized in hospitals, schools, hotels, offices, airports, stadiums, storefronts, and commercial and industrial buildings in new construction and retrofit applications for over 30 years.

Hager Roton continuous geared hinges are designed for superior performance. Because of this, we offer our lifetime warranty with confidence.

ANSI Standards

- 780 Series Roton continuous geared hinges are approved per ANSI A156.26 Grade 1 for 150 lb. doors
- 780 Series Roton heavy duty hinges are approved per ANSI A156.26 Grade 1 for 300 lb. doors
- 780-111, 780-112, 780-124HD, 780-224, 780-226 standard duty and heavy duty Roton continuous geared hinges are Warnock-Hersey certified in accordance with ANSI A250.13 2003 Standard Severe Windstorm Resistant Components.



Cancellation Notification

Cancellation for made to order items must be completed within 48 hours of order placement.



Standard Lengths

Roton hinges are listed and priced as actual lengths 79" (6'8" opening), 83" (7'0" opening), 85" (7'2" opening), 95" (8'0" opening), and 119" (10'0" opening) for convenience in application to nominal sized doors. Actual length provides for threshold clearance, head clearance and door height allowances for carpeting. Other lengths may be ordered as non-standard items.

Special Lengths

Should a non-standard length be required, please price as the next standard length. (For example, if 86" length is required, use 95" list price.)

Length Specifications

If special lengths to match the actual net door heights are required, please indicate this clearly on your order. A special length should be specified from the net door height, not the nominal height of the opening. To order specify: "Actual Length", or "Net Door Height". Use pricing for the next longer standard length from which the special length can be manufactured. For example, hinges 86-3/4" long will be invoiced at the 95" price.

Field Modifications

While Roton hinges can be cut in the field, any product modifications may void all warranties. Should in-the-field modifications be required, cut only from bottom of hinge. Do not cut through bearings or screw holes. When cutting electric hinges it is extremely important to clamp both hinge leaves securely to prevent hinge "chatter" which can damage the hinge's internal wiring. Consult the St. Louis sales office before proceeding.

Template Hinges

Hager has developed templated hole patterns for Roton hinge models in standard lengths. Drawings are available upon request by contacting Hager Customer Service or accessing the Hager website at www.hagerco.com.

Due to normal variances inherent in the manufacturing process, Roton custom length hinges are deemed by Hager to be non-templated.

Standard Finishes

Roton hinges are available in clear anodized satin aluminum (similar to US28), dark bronze and black exterior anodized coating.

Special Products

A special product is any product not listed in the price book in regard to length, finish, standard hole preparation or leaf combinations not illustrated. Orders for special products are encouraged, but any changes or cancellations on special orders may result in charges related to work performed and/or material loss. Under no circumstance will non-stock or make-to-order products be accepted for return unless due to Hager error.



Roton Continuous Hinges

FIRE RATINGS - UNDERWRITERS LABORATORY FIRE RATING FILE #A14627



780 Series Roton continuous geared hinges with stainless steel studs are approved for use on 4'x10' metal or wood swing type doors. 780 Series Roton continuous geared hinges without stainless steel studs are approved for use on 4'x8' single swing metal doors and 4'x10' single swing wood doors used without stainless steel studs limited to 20 minute fire rating without hose stream.

- Hollow metal, tin-clad, sheet-metal and steel covered composite type rated up to and including 3 hours
- Wood composite doors rated up to and including 1-1/2 hours
- Wood core doors rated up to 20 minutes without hose stream, non-studded
- 780 Series Roton Continuous Geared Hinges meet requirements for positive pressure UL10C, UL10B and UBC7-2 Part 1

UL10C Fire Rated Roton	Fully Concealed	Full Surface	Half Surface	NOTES: 1. All Roton hinges will be marked with UL stamp if they are fire-rated. 2. Several hinge models cannot be fire-rated. Check each profile. 3. Models that require studs have an extra charge. Four studs are required for UL stud hinges. Add to the hinge list price before applying buying group discount - add \$56.80.
20 Minute Fire Rated Wood Core Door x Fire Rated Hollow Metal Frame	UL — FF STANDARD			
20 Minute Fire Rated Metal Door x Fire Rated Hollow Metal Frame	UL — FF STANDARD			
30 Minute Fire Rated Wood Composite Door x Fire Rated Hollow Metal Frame	UL — FF STANDARD			
30 Minute Fire Rated Metal Door x Fire Rated Hollow Metal Frame	UL — FF STANDARD			
45 Minute Fire Rated Wood Composite Door x Fire Rated Hollow Metal Frame	UL — FF STANDARD			
45 Minute Fire Rated Metal Door x Fire Rated Hollow Metal Frame	UL — FF STANDARD			
60 Minute Fire Rated Wood Door x Hollow Metal Frame	UL — FF STANDARD			
60 Minute Fire Rated Metal Door x Hollow Metal Frame	UL — FF STANDARD			
90 Minute Fire Rated Metal Door x Fire Rated Hollow Metal Frame	UL — FF STANDARD			
90 Minute Fire Rated Wood Composite Door x Fire Rated Hollow Metal Frame	UL — STUD REQUIRED * Must Specify			
3 Hour Fire Rated Metal Door x Fire Rated Hollow Metal Frame	UL — STUD REQUIRED * Must Specify			

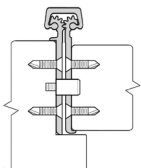

FULLY CONCEALED WITH STUD

Fully Concealed

These models are concealed between the frame and the hinge edge of the door. Models available include: 780-041HD, 780-041LL, 780-111, 780-111HD, 780-111LL, 780-112, 780-112HD, 780-112LL, 780--124HD, 780-124LL, 780-224, 780-224HD, 780-224LL, 780-226, 780-226HD, and 780-226LL.

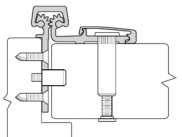

HALF SURFACE WITH STUD

Half Surface

These models have the frame leaf concealed between the frame and the edge of the door. The door leaf is mounted to the door with thru-bolts or screws. Models available include: 780-045HD, 780-046HD, 780-053, 780-053HD, and 780-054HD.

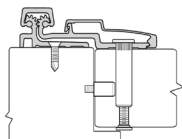

FULL SURFACE WITH STUD

Full Surface

These models have the frame leaf mounted to the face of the frame and the face of the door. The door leaf is mounted to the face of the door with thru-bolts. Models available include: 780-057HD, 780-157, 780-157HD, 780-210, and 780-210HD.



MODIFICATIONS & ADDITIONS

Special Cover Channels

Rounded back cover channels may be ordered. Availability for hinges with electrical modifications vary.

Please consult the St. Louis sales office for confirmation. Add to the hinge list price before applying buying group discount:

Round Back Cover Channels

Clear Anodized

79", 83", 85"	\$35.24
95"	\$43.69
119"	\$56.23

Bronze Anodized

79", 83", 85"	\$70.29
95"	\$78.67
119"	\$89.95

Black Anodized

79", 83", 85"	\$80.85
95"	\$90.55
119"	\$103.49

Note: Special cover channels available in clear, dark bronze and black finish.

Roton Cover Channel Compatibility		
Hinge Model	Flat FBCC	Round RBCC
750-134	•	
750-138	•	
780-041	•	•
780-045	•	•
780-046	•	•
780-053	•	•
780-054	•	•
780-057	•	•
780-110	•	•
780-111	•	•
780-112	•	•
780-113	•	•
780-124	•	•
780-155	•	•
780-157	•	
780-210	•	•
780-211	•	•
780-224	•	•
780-226	•	•
780-259	•	•

* Round back (RBCC) is not compatible with molded Hospital Tip option.



Roton Continuous Hinges

MODIFICATIONS & ADDITIONS PRICE

ADDITION TO LIST

Bone White Painted Cover Channels

For hinges 79", 83" and 85" in length

\$84.41

For hinges 95" in length

\$115.24

For hinges 119" in length

\$171.34

Roton cover channels are offered in bone white as a standard stock color option. This is only available on the standard Roton cover channel and should be ordered as bone white paint # UC43350.

Polished Cover Channels

CLEAR

GOLD

For hinges 79" in length

\$84.41

\$115.24

For hinges 83" in length

\$84.41

\$115.24

For hinges 85" in length

\$84.41

\$115.24

For hinges 95" in length

\$115.24

\$143.22

For hinges 119" in length

\$169.88

\$196.55

Any hinge may be ordered with a polished clear cover channel (similar to US26) to complement clear anodized hinge leaves or a polished gold cover channel (similar to US3) to complement satin gold hinge leaves.

Special Finished Hinges

Price on Application

Hager Companies can supply unfinished material to selected finishers for special projects that require unusual colors, but will require that final assembly be complete by Hager Companies. Because of special non-removable metal coatings applied to all hinges during assembly, users are cautioned against attempting to refinish any Roton product. Lead time of up to 10-12 weeks may be required.

Cannot paint 500 or 1200 series hinges.

Special Anodizing

Add 20% to the DBA hinges for gold

Roton hinges are available in various special colors including Black, Gold, and other special anodized finishes with fasteners to match. Example, specify "Black Anodized" or "Gold Anodized." All hinges ordered in special colors should be ordered at the same time to guarantee finish uniformity.

Other anodized colors by quotation only. Supply color chip for best match.

Special Holes

Price on Application

Any hinge may be ordered with special hole locations for unusual frame or door locations. Please provide specification for each leaf.

ROTON ELECTRICAL MODIFICATIONS

- A = Opening
- B = Door height
- C = Actual hinge length
- D = C.L. of EMN (electric monitor)
- E = C.L. of ETM (electric through-wires & monitor)
- F = C.L. of ETW (electric through-wires)
- G = C.L. of EPT (electric power transfer)
- H = C.L. of E1S (exposed switch)
- J = C.L. of E (exposed contact)
- K = C.L. of RETW (removable electric through-wires)

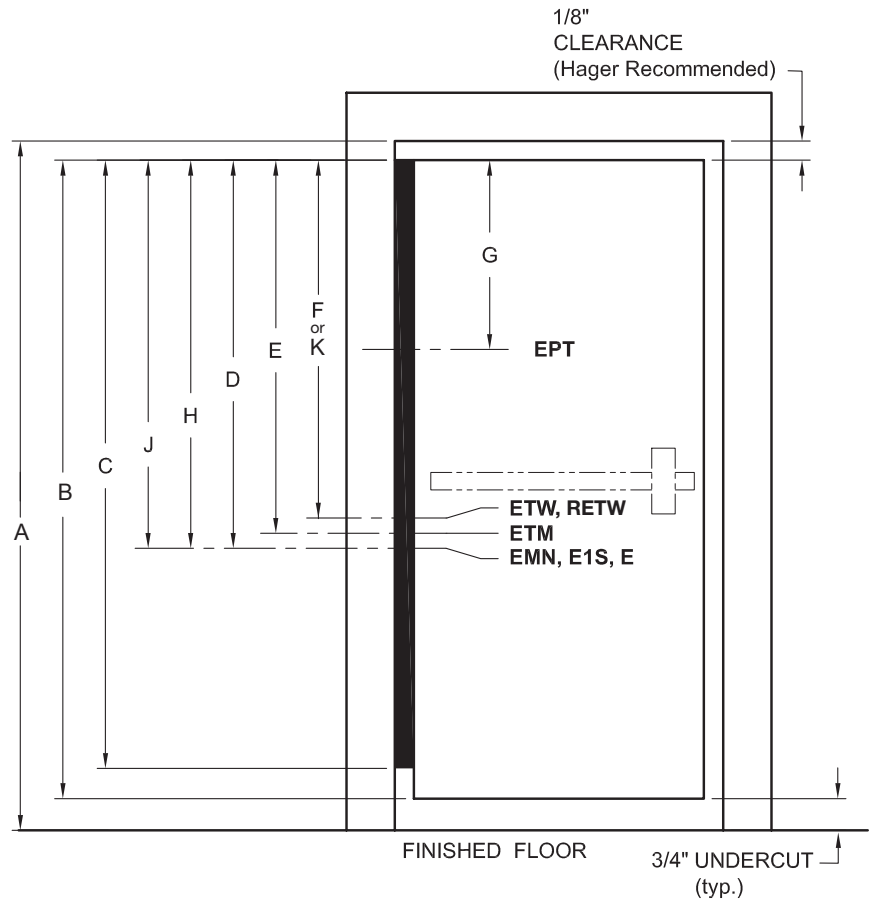

For ease of ordering, Hager Companies has established standard locations for power transfer cutouts. All standard location dimensions are referenced from the top edge of the door to the centerline of the power transfer cutout. Please specify handing.

	Opening	Door Height	Actual Hinge Length	EMN	ETM	ETW	EPT	E1S	E	RETW
79 SD	80"	79-1/8"	79"	40-3/4"	42-3/4"	40-3/4"	34-3/8"	42-1/2"	42-1/2"	-
79 HD	80"	79-1/8"	79"	40-3/4"	43-3/8"	40-3/4"	34-3/8"	42-1/2"	42-1/2"	43-3/8"
83 SD	84"	83-1/8"	83"	45-5/16"	44-3/4"	45-5/16"	36-3/8"	46-1/2"	46-1/2"	-
83 HD	84"	83-1/8"	83"	45-5/16"	45-3/8"	45-5/16"	36-3/8"	46-1/2"	46-1/2"	45-3/8"
85 SD	86"	85-1/8"	N/A	N/A	N/A	N/A	N/A	N/A	N/A	N/A
85 HD	86"	85-1/8"	85"	46-5/16"	46-3/8"	46-5/16"	37-3/8"	48-1/2"	48-1/2"	46-3/8"
95 SD	96"	95-1/8"	95"	56-3/8"	55-13/16"	56-3/8"	47-1/2"	59-3/4"	59-3/4"	-
95 HD	96"	95-1/8"	95"	56-3/8"	56-1/2"	56-3/8"	47-1/2"	59-3/4"	59-3/4"	56-1/2"
119 SD	120"	119-1/8"	N/A	N/A	N/A	N/A	N/A	N/A	N/A	N/A
119 HD	120"	119-1/8"	119"	81-1/4"	81-5/16"	81-1/4"	72-5/16"	83-3/4"	83-3/4"	81-5/16"

SD = Standard Duty

HD = Heavy Duty



Roton Continuous Hinges

ROTON ELECTRICAL MODIFICATIONS (CONTINUED)

	Von Duprin EPT 2 or EPT 10 Power Transfer Preparation	Exposed Electric Contacts	Exposed Electric Switches	Concealed Electric Through-Wire	Concealed Electric Monitoring	Concealed Electric Through-Wire and Monitoring	Removable Electric Through-Wire
Part Number	EPT	E	E1S	ETW	EMN	ETM	RETW
780-045HD	•						
780-046HD	•						
780-053	•						
780-053HD	•						
780-054HD	•						
780-110HD			•				
780-057				•			•
780-111	•	•	•	•	•	•	
780-111HD	•	•	•	•	•	•	•
780-111LL	•	•	•	•	•	•	
780-112	•	•	•	•	•	•	
780-112HD	•	•	•	•	•	•	•
780-112LL	•	•	•	•	•	•	
780-124HD	•	•	•	•	•	•	•
780-124LL	•	•	•	•	•	•	
780-157				•			•
780-224	•	•	•	•	•	•	
780-224HD	•	•	•	•	•	•	•
780-224LL	•	•	•	•	•	•	
780-226HD	•	•	•	•	•	•	•
780-226LL	•	•	•	•	•	•	
1200-600	•			•			
1200-650	•			•			



**MODIFICATIONS & ADDITIONS
PRICE**

ADDITION TO LIST

Quick Connect

\$63.23

Available for ETM, ETW, and RETW options. Top and bottom knockouts for standard conduit fittings.

Concealed Electric Monitoring (EMN)

\$354.29

- Miniature switch is incorporated into the frame leaf.
- Specify handing and the dimension from the top edge of the door to the centerline of the electric monitoring location.
- Special Electric Modifications and EPT locations may require additional charges if screw holes have to be moved.
- Templates regarding location of monitoring switch available upon request.

Concealed Electric Through-Wire and Monitoring (ETM)

- Electric Preparation

ETM-4

\$707.13

ETM-8

\$820.78

ETM-10

\$874.17

- All ETM have 28-Gauge continuous conductors.
- This combines the continuous electric conductors and the miniature switch to provide both power transfer and monitoring.
- Miniature switch is incorporated into the frame leaf.
- Specify handing and the dimension from the top edge of the door to the centerline of each electric modification location.
- Templates regarding location of monitoring switch available upon request.

Concealed Electric Through-Wire (ETW)

- Electric Preparation

ETW-4

\$354.29

ETW-8

\$461.21

ETW-10

\$525.36

ETW-12

\$587.93

- All ETW have 28-Gauge continuous conductors.
- 12" per side required as a suffix.
- Cut out for prep - 1/2" drilled hole.
- Transfers power discreetly from building to door hardware.
- Specify handing and the dimension from the top edge of the door to the centerline of the electric through-wire location.
- Special electric modifications and EPT locations may require additional charges if screw holes have to be moved. Contact Hager Customer Service for charges.
- Templates regarding location of through-wires available upon request.

Available on the following Roton profiles:

- 780-057HD • 780-112HD • 780-157HD • 780-226HD • 1200-650HD
- 780-111HD • 780-124HD • 780-224HD • 1200-600HD

Power Transfer or Electric Power Transfer Preparation (EPT)

Concealed Leaf

\$137.81

Half Surface

\$83.03

- Hinge leaf cutout to accommodate power transfer device.
- Specify handing and the dimension from the top edge of the door to the **centerline** of the power transfer location.
- Special Electric Modifications and EPT locations may require additional charges if screw holes have to be moved.



Roton Continuous Hinges

MODIFICATIONS & ADDITIONS PRICE

ADDITION TO LIST

Lead Wire for Concealed Electric Hinges

Electric Preparation

4-wire hinge

8-wire hinge

10-wire hinge

- Standard wire leads are 12" per side
- Additional wire leads are available

Per Foot

\$12.21

\$22.18

\$25.15

Exposed Electric Switches (E1S)

\$123.82

- Miniature push button switch incorporated in hinge frame leaf to monitor position of the door.
- Three 12" wire leads.
- Each monitoring hinge only needs one E1S Switch.
- Specify handing and the dimension from the top edge of the door to the centerline of the electric switch location.
- Templates regarding location of contact switch available upon request.

Exposed Electric Contacts (E)

\$123.82

- Transfers power to door in closed position.
- Must have at least two (2) contacts to transfer power.
- Specify handing and the dimension from the top edge of the door to the centerline of the electric contact location.
- Templates regarding location of contacts available upon request.

Removable Electric Through-Wire (RETW) Twelve Wire

\$859.91

Removable 12 Wire Module Only

\$350.66

Component

Finish

7-102-1870

Clear

7-112-1872

Dark Bronze

7-112-1876

Gold

7-112-1881

Black

Removable Electric Through-Wire (RETW) Ten Wire

\$728.77

Removable 10 Wire Module Only

\$283.67

Component

Finish

7-102-1860

Clear

7-112-1870

Dark Bronze

7-112-1875

Gold

7-112-1880

Black

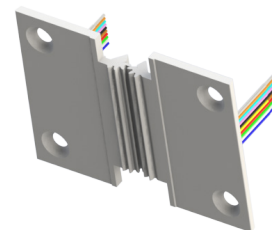

Available on heavy duty profiles:

- 780-057HD
- 780-112HD
- 780-157HD
- 780-226HD
- 780-111HD
- 780-124HD
- 780-224HD

- Transfers power discreetly from building to door hardware.
- Removable ETW module can be easily removed for adjustment for service.
- Templates regarding location of monitoring switch available upon request.
- Specify handing and the dimension from the top edge of the door to the centerline of the electric through-wire location.



MODIFICATIONS & ADDITIONS

Mortar Box - 430

\$91.40

- Serves as a mortar shield.
- Overall dimensions: 9" (229 mm) length with tabs, 7" (178 mm) inside, 1-3/4" x 1-3/4" (45 mm x 45 mm) inside dimension.
- Galvanized steel 0.040" (1 mm)

**Replacement Molding
780-052M**

Hinge Lengths

79", 83", 85"
95"
119"

Clear Anodized

\$50.95
\$58.87
\$70.29

Dark Bronze Anodized

\$58.87
\$70.29
\$81.58

Replacement door leaf molding for: 780-053, 780-053HD, 780-054HD, 780-155HD, 780-057HD, 780-157, 780-157HD, and 780-259HD.

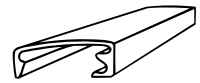
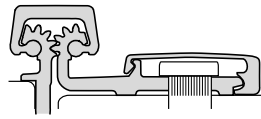

**Replacement Molding
780-210M**

Hinge Lengths

79", 83", 85"
95"
119"

Clear Anodized

\$53.59
\$66.26
\$77.62

Dark Bronze Anodized

\$66.26
\$77.62
\$87.71

Replacement door leaf molding for: 780-210, 780-210HD, 780-211, 780-045HD, and 780-046HD.

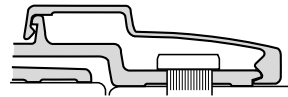

**Replacement Molding
780-247M**

Hinge Lengths

79", 83", 85"
95"
119"

Clear Anodized

\$45.54
\$53.59
\$66.26

Dark Bronze Anodized

\$53.59
\$66.26
\$77.62

Replacement frame leaf molding
780-157, 780-157HD

Note: Replacement moldings for 780-052M and 780-210M are shipped in stock lengths for trimming in the field and furnished with Allen head set screw and wrench.

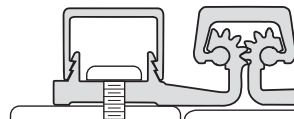

Roton Continuous Hinges

MODIFICATIONS & ADDITIONS PRICE

ADDITION TO LIST

Short Hinges

\$29.44

Hinges shorter than 79" will be invoiced at the 79" price. Where two or more short hinges can be obtained from a standard length, pricing is based on the number of standard lengths utilized plus an assembly charge for each hinge.

Extra Long Hinges

\$128.70

Hinges over 119" are manufactured as two separate lengths with a staggered joint for on-site connection. Hinge segments are taken from standard sizes for best economics in relation to the quantity required. Handing specifications are required to position the cuts inconspicuously and to finish symmetrical pairs in double door applications.

Custom Hole Pattern

Price on Application Any

hinge may be ordered with special hole locations for unusual frame or door conditions. Please provide specifications for each leaf.

Bearing At Top

\$54.78

This application allows for the bearing to be set at the very top of the cover channel. The cover channel is flush with the top of the geared hinge, preventing any obstructions or debris from being inserted in the top of the channel.

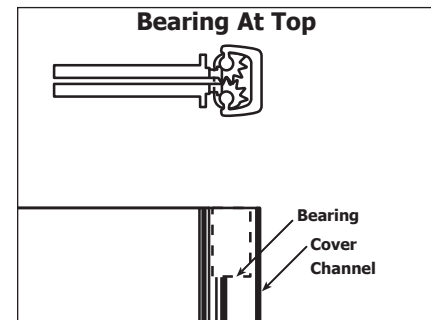

780 Series Concealed Molded Hospital Tip

\$161.70

780 Series Concealed and several Full Surface models can be prepared with a smooth tapered top bearing. This option is ideal for use in hospitals and correctional facilities to help provide a clean and safe environment. For Roton® Ligature-Resistant Opening Solutions see our TIPIT® section below. Not compatible with the round back cover channel option. For complete list of compatible models for this option, please reference chart on page 13.



Hospital Tip and TIPIT® Compatibility		
Part #	Molded Hospital Tip	TIPIT®
750-134		•
750-138		•
780-045		•
780-046		•
780-053		•
780-054		•
780-057	•	
780-110	•	•
780-111	•	•
780-112	•	•
780-113	•	•
780-124	•	•
780-155		•
780-210	•	•
780-211		
780-224	•	•
780-226	•	•



Roton Continuous Hinges

MODIFICATIONS & ADDITIONS

TIPIT®

Designed to work with in new and retrofit applications, the TIPIT® was designed with safety in mind. When openings are fitted with the patented TIPIT® in conjunction with our Roton® Continuous Geared Hinge, this combination provides a safe environment while meeting institutional requirements for preventing objects from being hung from the top of the hinge.

Concealed

\$76.56



Full Surface (Gray or Black)

\$194.04



Tamper Resistant Hinge

\$189.82

This application is intended for use in hospital psychiatric areas and places of high security. The hinge is **prepared with a hospital tip** and every other bearing is supplied with a set screw to lock against the inside of the cover channel for additional security. 780 Series Concealed and Full Surface models (780-057, 780-157, and 780-210) are available in this configuration. Torx screws available at additional charge (see page 15).

Dutch Door Prep

\$112.40

Furnished as continuous frame leaf, whole door leaf is cut to fit dutch door specified length.

Bearing Replacement Kit

Standard Duty for 780 Series

Heavy Duty for 780 Series

Extra Heavy Duty for 1200 Series

Clear and Dark Bronze

\$ 57.62

\$109.69

\$218.00

Center Punches

Self-Centering center punches are available for #12 countersunk screws supplied. To make sure screw heads seat properly, accurate center punching is required.

\$12.87

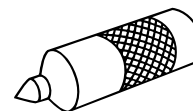

**MODIFICATIONS & ADDITIONS
PRICE**

ADDITION TO LIST

Shim Stock

1/16" x 1-1/2" Wide x 7' Long

1/8" x 1-1/2" Wide x 7' Long

\$44.35 each

\$61.84 each

Larger sizes available

Price on application

For clearance between the door and frame which may be excessive, a continuous shim is helpful (applied behind the frame leaf only). Anodized aluminum extrusions are supplied with no holes.

Shipping Carton

\$30.95 each

Extra shipping cartons are available for reshipping hinges in quantities of 2 or less.

Fasteners

All hinges are shipped with appropriate fasteners for metal doors and frames except where noted. **If wood screws are required, please specify on order, and wood screws will be substituted at no extra charge.** Bulk screws are packed separately.

Description	Part Numbers		
	Clear	Dark Bronze	
#12 x 1-1/2" Flat Head Wood Screw	7-080-0050	7-080-0051	\$342.80/box of 500
#12-24 x 11/16" Self-Drilling Flat Head Screw	7-080-0070	7-080-0072	\$306.50/box of 500
#12-24 x 1/2" Spanner Head Machine Screw			\$2.77 each
#12-24 x 11/16" Drill Quick Torx Screw			\$2.77 each
#12-24 x 13/32" Self-Threading Screw (Clear or Bronze)			\$1.12 each
#12-24 x 11/16" Self-Drilling Flat Head Screw (Clear or Bronze)			\$1.58 each
#12-24 x 11/16" Self-Drilling Pan Head Screw (Clear)			\$1.58 each
#12 x 1-1/2" Flat Head Wood Screw (Clear or Bronze)			\$1.58 each
Sexbolts			\$4.09 each

Note: Additional fasteners may be ordered as follows (add to the hinge list price before applying buying group discount).



Roton Continuous Geared Hinges

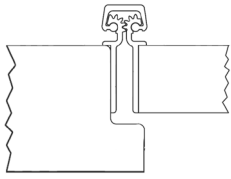

Description	Size	Finish	2022 List	Stock No.	Case Qty.
500-048 Concealed Leaf With Sheet Metal Screws 1-1/6" Nominal Leaf Thickness	24" (610 mm)	Clear	97.48	068560	1
		Dark Bronze	129.89	068046	
	36" (914 mm)	Clear	110.42	068521	1
		Dark Bronze	146.19	-	
	48" (1219 mm)	Clear	129.89	068520	1
		Dark Bronze	162.36	067970	
	72" (1829 mm)	Clear	162.36	068509	1
		Dark Bronze	194.83	067969	

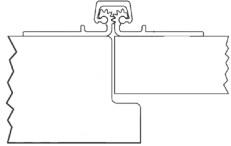

500-220 Full Surface With Sheet Metal Screws 1-1/6" Nominal Leaf Thickness	24" (610 mm)	Clear	97.48	067944	1
		Dark Bronze	129.89	-	
	36" (914 mm)	Clear	113.72	067940	1
		Dark Bronze	146.19	067009	
	48" (1219 mm)	Clear	129.89	067939	1
		Dark Bronze	162.36	067001	
	72" (1829 mm)	Clear	162.36	067938	1
		Dark Bronze	194.83	067000	

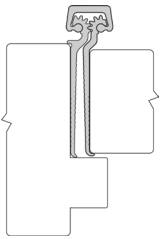

750-134 Concealed Leaf With Half Drill Quick and Half Wood Screws 1-3/4" Interior Wood Door	79" (2007 mm)	Clear	210.08	194853	8
	83" (2108 mm)	Clear	210.08	194855	8
	85" (2159 mm)	Clear	210.08	194859	8
	95" (2413 mm)	Clear	267.16	194861	8
	119" (3023 mm)	Clear	413.49	194863	6

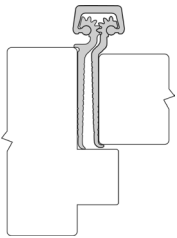

750-138 Concealed Leaf With Half Drill Quick and Half Wood Screws 1-3/8" Interior Wood Door	79" (2007 mm)	Clear	213.77	194890	8
	83" (2108 mm)	Clear	213.77	194897	8
	85" (2159 mm)	Clear	213.77	194909	8
	95" (2413 mm)	Clear	261.49	-	8
	119" (3023 mm)	Clear	403.26	-	8

Roton Continuous Geared Hinges

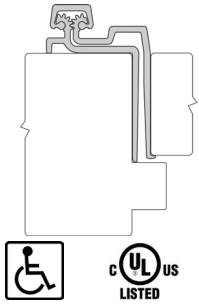

Description	Size	Finish	2022 List	Stock No.	Case Qty.
780-041HD Concealed Leaf Heavy Duty 1-3/4" Door Swing Clear Action	79" (2007 mm)	Clear	478.37	194918	6
		Dark Bronze	634.92	194919	
		Black	730.22	-	
	83" (2108 mm)	Clear	478.37	194803	6
		Dark Bronze	634.92	194920	
		Black	730.22	-	
	85" (2159 mm)	Clear	478.37	194921	6
		Dark Bronze	634.92	194923	
		Black	730.22	-	
95" (2413 mm)	Clear	592.94	194805	6	
	Dark Bronze	781.04	194924		
	Black	898.13	-		
119" (3023 mm)	Clear	885.06	194925	2	
	Dark Bronze	1,164.11	194926		
	Black	1,338.74	-		

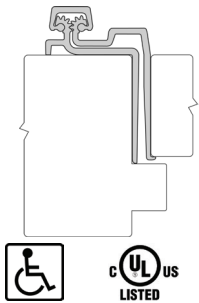

780-041LL Concealed Leaf With Half Drill Quick and Half Wood Screws 1-3/4" Door Lead Lined Heavy Duty Profile Only Swing Clear Action	79" (2007 mm)	Clear	497.51	187432	6
		Dark Bronze	650.76	-	
		Black	748.44	-	
	83" (2108 mm)	Clear	497.51	022711	6
		Dark Bronze	650.76	073552	
		Black	748.44	-	
	85" (2159 mm)	Clear	497.51	095167	6
		Dark Bronze	650.76	-	
		Black	748.44	-	
95" (2413 mm)	Clear	608.92	-	6	
	Dark Bronze	796.88	-		
	Black	916.48	-		
119" (3023 mm)	Clear	899.58	-	2	
	Dark Bronze	1,180.08	-		
	Black	1,357.09	-		

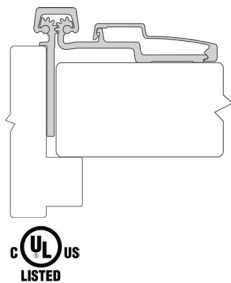

780-045HD Half Surface Heavy Duty	79" (2007 mm)	Clear	567.20	194937	4
		Dark Bronze	758.21	-	
		Black	871.99	-	
	83" (2108 mm)	Clear	567.20	194938	4
		Dark Bronze	758.21	194939	
		Black	871.99	-	
	85" (2159 mm)	Clear	567.20	194940	4
		Dark Bronze	758.21	194942	
		Black	871.99	-	
95" (2413 mm)	Clear	697.22	194943	4	
	Dark Bronze	932.58	194944		
	Black	1,072.34	47150		
119" (3023 mm)	Clear	1,038.71	194945	2	
	Dark Bronze	1,387.32	194947		
	Black	1,595.48	-		



Roton Continuous Geared Hinges

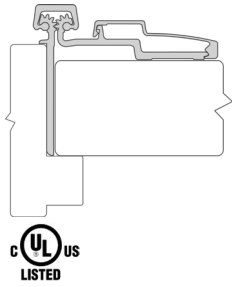

Description	Size	Finish	2022 List	Stock No.	Case Qty.
780-046HD Half Surface Heavy Duty	79" (2007 mm)	Clear	610.50	194948	4
		Dark Bronze	800.84	-	
		Black	920.96	-	
	83" (2108 mm)	Clear	610.50	194949	4
		Dark Bronze	800.84	194950	
		Black	920.96	88082	
	85" (2159 mm)	Clear	610.50	194951	4
		Dark Bronze	800.84	197942	
		Black	920.96	-	
	95" (2413 mm)	Clear	748.57	194952	4
		Dark Bronze	995.41	194953	
		Black	1,144.70	-	
	119" (3023 mm)	Clear	1,118.30	99397	2
		Dark Bronze	1,481.96	81736	
		Black	1,704.25	-	

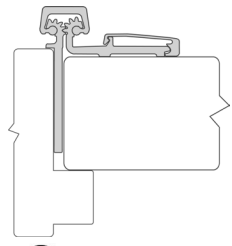

780-053 Half Surface	79" (2007 mm)	Clear	296.74	194464	5
		Dark Bronze	408.01	194990	
		Black	469.13	-	
	83" (2108 mm)	Clear	296.74	194991	5
		Dark Bronze	408.01	194992	
		Black	469.13	135666	
	95" (2413 mm)	Clear	367.62	194993	5
		Dark Bronze	497.24	194994	
		Black	571.82	199830	

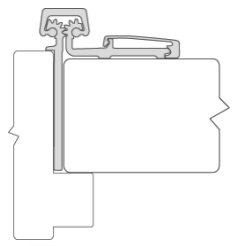

780-053HD Half Surface Heavy Duty	79" (2007 mm)	Clear	372.24	194996	5
		Dark Bronze	466.88	194997	
		Black	536.98	66022	
	83" (2108 mm)	Clear	372.24	194998	5
		Dark Bronze	466.88	194999	
		Black	536.98	63779	
	85" (2159 mm)	Clear	372.24	195002	5
		Dark Bronze	466.88	195003	
		Black	536.98	-	
	95" (2413 mm)	Clear	461.87	195004	5
		Dark Bronze	559.55	195005	
		Black	643.50	199831	
	119" (3023 mm)	Clear	706.99	195006	3
		Dark Bronze	943.80	195007	
		Black	1,085.44	-	

Roton Continuous Geared Hinges

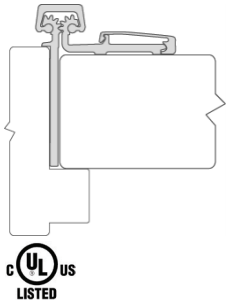

Description	Size	Finish	2022 List	Stock No.	Case Qty.
780-054HD Half Surface Heavy Duty	79" (2007 mm)	Clear	406.56	195050	5
		Dark Bronze	500.02	195051	
		Black	574.99	-	
	83" (2108 mm)	Clear	406.56	195052	5
		Dark Bronze	500.02	195053	
		Black	574.99	80289	
	85" (2159 mm)	Clear	406.56	195054	5
		Dark Bronze	500.02	195055	
		Black	574.99	-	
95" (2413 mm)	Clear	502.66	195056	5	
	Dark Bronze	594.66	195057		
	Black	683.76	99659		
119" (3023 mm)	Clear	733.26	195058	3	
	Dark Bronze	998.05	195059		
	Black	1,147.74	72407		

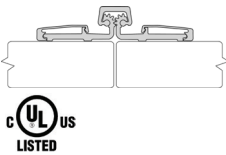

780-057HD Full Surface Heavy Duty Bi-Fold Applications	79" (2007 mm)	Clear	434.28	021238	5
		Dark Bronze	613.27	017850	
		Black	705.28	-	
	83" (2108 mm)	Clear	434.28	007856	5
		Dark Bronze	613.27	025973	
		Black	705.28	-	
	85" (2159 mm)	Clear	434.28	025846	5
		Dark Bronze	613.27	174835	
		Black	705.28	-	
	95" (2413 mm)	Clear	552.16	024478	5
		Dark Bronze	759.26	094331	
		Black	873.18	-	
	119" (3023 mm)	Clear	823.02	088469	4
		Dark Bronze	1,130.84	165568	
		Black	1,300.46	-	

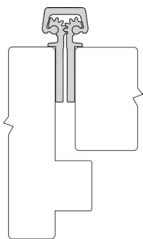

780-110HD Concealed Leaf Heavy Duty For 1" to 1-3/8" door	79" (2007 mm)	Clear	276.14	100071	8
		Dark Bronze	356.80	196487	
		Black	410.26	-	
	83" (2108 mm)	Clear	276.14	110418	8
		Dark Bronze	356.80	111266	
		Black	410.26	84514	
	85" (2159 mm)	Clear	276.14	112381	8
		Dark Bronze	356.80	173953	
		Black	410.26	63320	
	95" (2413 mm)	Clear	331.85	112392	8
		Dark Bronze	430.06	112393	
		Black	494.60	90279	
	119" (3023 mm)	Clear	525.62	112405	7
		Dark Bronze	690.23	112406	
		Black	793.85	91587	



Roton Continuous Geared Hinges

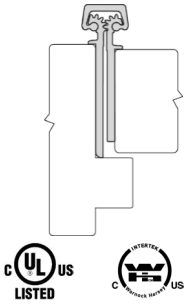

Description	Size	Finish	2022 List	Stock No.	Case Qty.
780-111 Concealed Leaf	79" (2007 mm)	Clear	215.69	194809	8
		Dark Bronze	278.65	194810	
		Black	320.43	60918	
	83" (2108 mm)	Clear	215.69	184007	8
		Dark Bronze	278.65	184008	
		Black	320.43	80025	
	95" (2413 mm)	Clear	262.81	184031	8
		Dark Bronze	341.75	184048	
		Black	392.96	98769	

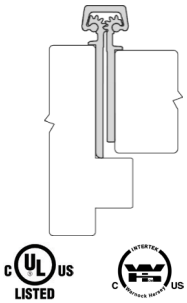

780-111HD Concealed Leaf Heavy Duty	79" (2007 mm)	Clear	268.36	183917	8
		Dark Bronze	350.46	194812	
		Black	403.13	-	
	83" (2108 mm)	Clear	268.36	183924	8
		Dark Bronze	350.46	183988	
		Black	403.13	116592	
	85" (2159 mm)	Clear	268.36	194814	8
		Dark Bronze	350.46	194815	
		Black	403.13	83711	
	95" (2413 mm)	Clear	325.78	184025	8
		Dark Bronze	421.34	194816	
		Black	484.57	109310	
	119" (3023 mm)	Clear	520.61	194817	7
		Dark Bronze	677.95	194819	
		Black	779.59	113845	

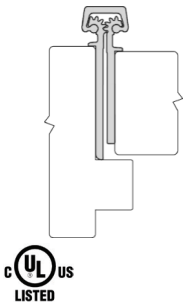

780-111LL Concealed Leaf With Half Drill Quick and Half Wood Screws Lead Lined Heavy Duty Profile Only	79" (2007 mm)	Clear	290.40	194848	8
		Dark Bronze	369.07	-	
		Black	424.51	-	
	83" (2108 mm)	Clear	290.40	195079	8
		Dark Bronze	369.07	195080	
		Black	424.51	-	
	85" (2159 mm)	Clear	290.40	-	8
		Dark Bronze	369.07	-	
		Black	424.51	-	
	95" (2413 mm)	Clear	345.18	195088	8
		Dark Bronze	439.82	195089	
		Black	505.82	-	
	119" (3023 mm)	Clear	534.60	-	7
		Dark Bronze	697.22	-	
		Black	801.90	-	

Roton Continuous Geared Hinges

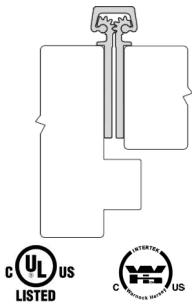

Description	Size	Finish	2022 List	Stock No.	Case Qty.
780-112 Concealed Leaf Single Pack w/ Drill Quick Screws	79" (2007 mm)	Clear	181.63	183922	8
		Dark Bronze	234.56	194822	
		Black	269.81	74006	
	83" (2108 mm)	Clear	181.63	184001	8
		Dark Bronze	234.56	184003	
		Black	269.81	136045	
	95" (2413 mm)	Clear	222.42	184032	7
		Dark Bronze	292.91	184033	
		Black	336.86	126429	
780-112 Concealed Leaf Case Pack w/ Drill Quick Screws Must Order Case Quantity	83" (2108 mm)	Clear	163.42	184009	8
		Dark Bronze	211.20	184010	
		Black	248.88	-	
780-112HD Concealed Leaf Single Pack w/ Drill Quick Screws	79" (2007 mm)	Clear	225.59	183881	8
		Dark Bronze	291.46	194826	
		Black	335.15	128859	
	83" (2108 mm)	Clear	225.59	183926	8
		Dark Bronze	291.46	183932	
		Black	335.15	110422	
	85" (2159 mm)	Clear	225.59	184011	8
		Dark Bronze	291.46	184013	
		Black	335.15	123296	
	95" (2413 mm)	Clear	271.79	184020	7
		Dark Bronze	358.38	184021	
		Black	412.10	123220	
	119" (3023 mm)	Clear	437.18	184038	7
		Dark Bronze	576.05	194827	
		Black	662.51	114187	
780-112HD Concealed Leaf Case Pack w/ Drill Quick Screws Must Order Case Quantity	83" (2108 mm)	Clear	206.45	109235	8
		Dark Bronze	262.42	80053	
		Black	301.75	183989	
780-112LL Concealed Leaf With Half Drill Quick and Half Wood Screws Lead Lined Heavy Duty Profile Only	79" (2007 mm)	Clear	248.82	195090	8
		Dark Bronze	325.25	-	
		Black	374.09	-	
	83" (2108 mm)	Clear	248.82	195091	8
		Dark Bronze	325.25	195092	
		Black	374.09	83861	
	85" (2159 mm)	Clear	248.82	195093	8
		Dark Bronze	325.25	-	
		Black	374.09	-	
	95" (2413 mm)	Clear	302.68	195094	8
		Dark Bronze	388.08	195095	
		Black	446.95	-	
	119" (3023 mm)	Clear	482.86	195096	7
		Dark Bronze	630.96	197874	
		Black	725.60	-	

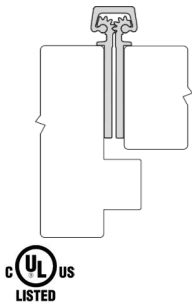
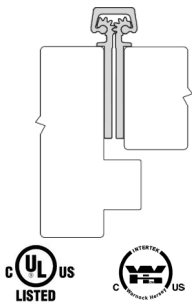

Roton Continuous Geared Hinges

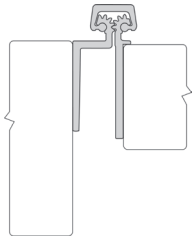

Description	Size	Finish	2022 List	Stock No.	Case Qty.
780-113HD Concealed Leaf Heavy Duty "Safety Hinge" When Used Without Frame Stop	79" (2007 mm)	Clear	456.72	195097	6
		Dark Bronze	614.06	195098	
		Black	706.20	-	
	83" (2108 mm)	Clear	456.72	195099	6
		Dark Bronze	614.06	195100	
		Black	706.20	-	
	85" (2159 mm)	Clear	456.72	195101	6
		Dark Bronze	614.06	195102	
		Black	706.20	-	
	95" (2413 mm)	Clear	748.57	195103	6
		Dark Bronze	840.58	195104	
		Black	966.64	-	
	119" (3023 mm)	Clear	929.02	195105	4
		Dark Bronze	1,098.11	-	
		Black	1,262.84	-	

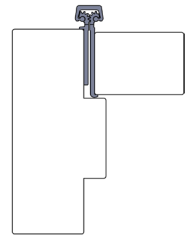

780-124HD Concealed Leaf Heavy Duty profile only Single Pack w/ Drill Quick Screws	79" (2007 mm)	Clear	229.28	194831	8
		Dark Bronze	298.58	194832	
		Black	343.46	-	
	83" (2108 mm)	Clear	229.28	183991	8
		Dark Bronze	298.58	194834	
		Black	343.46	140988	
	85" (2159 mm)	Clear	229.28	194835	8
		Dark Bronze	298.58	197391	
		Black	343.46	-	
	95" (2413 mm)	Clear	277.33	194836	7
		Dark Bronze	333.30	194837	
		Black	383.33	-	
	119" (3023 mm)	Clear	450.65	194838	7
		Dark Bronze	590.57	-	
		Black	679.14	-	

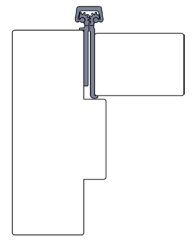

780-124LL Concealed Leaf Heavy Duty profile only With half drill quick and Half Wood Screws Lead Lined	79" (2007 mm)	Clear	258.59	55498	8
		Dark Bronze	333.30	-	
		Black	383.33	-	
	83" (2108 mm)	Clear	258.59	195114	8
		Dark Bronze	333.30	74529	
		Black	383.33	-	
	85" (2159 mm)	Clear	258.59	197934	8
		Dark Bronze	333.30	-	
		Black	383.33	-	
	95" (2413 mm)	Clear	310.60	75300	7
		Dark Bronze	391.91	-	
		Black	450.78	-	
	119" (3023 mm)	Clear	493.28	49286	7
		Dark Bronze	639.94	-	
		Black	735.90	-	



Roton Continuous Geared Hinges

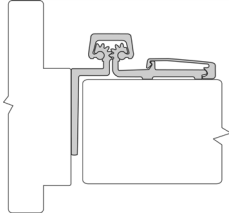

Description	Size	Finish	2022 List	Stock No.	Case Qty.
780-155HD Half Surface Heavy Duty Center Hung and Egress Conversions	79" (2007 mm)	Clear	479.69	016603	5
		Dark Bronze	645.88	128736	
		Black	742.90	-	
	83" (2108 mm)	Clear	479.69	068088	5
		Dark Bronze	645.88	068371	
		Black	742.90	71061	
	85" (2159 mm)	Clear	479.69	018276	5
		Dark Bronze	645.88	046665	
		Black	742.90	-	
	95" (2413 mm)	Clear	588.59	063096	5
		Dark Bronze	796.36	056566	
		Black	915.82	196310	
119" (3023 mm)	Clear	875.95	078745	2	
	Dark Bronze	1,183.91	062632		
	Black	1,361.45	-		
780-157 Full Surface Frame Face Dimension Limitations	79" (2007 mm)	Clear	279.31	022092	5
		Dark Bronze	377.26	049196	
		Black	433.88	85841	
	83" (2108 mm)	Clear	279.31	048049	5
		Dark Bronze	377.26	063070	
		Black	433.88	159357	
	95" (2413 mm)	Clear	341.48	021262	5
		Dark Bronze	460.81	009045	
		Black	529.85	170884	

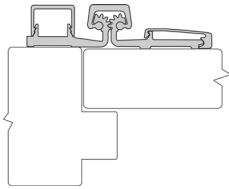

Roton Continuous Geared Hinges

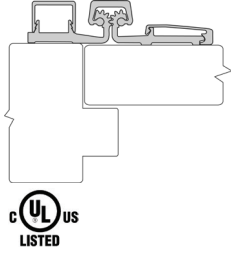

Description	Size	Finish	2022 List	Stock No.	Case Qty.
780-157HD Full Surface Heavy Duty Frame Face Dimension Limitations	79" (2007 mm)	Clear	346.10	022028	5
		Dark Bronze	422.00	084386	
		Black	485.36	94867	
	83" (2108 mm)	Clear	346.10	048059	5
		Dark Bronze	422.00	062422	
		Black	485.36	36598	
	85" (2159 mm)	Clear	346.10	019546	5
		Dark Bronze	422.00	035156	
		Black	485.36	188600	
	95" (2413 mm)	Clear	415.27	048060	5
		Dark Bronze	507.01	010547	
		Black	583.04	112593	
	119" (3023 mm)	Clear	688.25	099644	2
		Dark Bronze	898.02	037141	
		Black	1,030.39	189834	
780-210 Full Surface	79" (2007 mm)	Clear	279.31	010064	6
		Dark Bronze	377.26	073030	
		Black	433.88	60919	
	83" (2108 mm)	Clear	279.31	048050	6
		Dark Bronze	377.26	048051	
		Black	433.88	45510	
	95" (2413 mm)	Clear	334.22	063037	6
		Dark Bronze	455.27	020588	
		Black	523.51	068541	

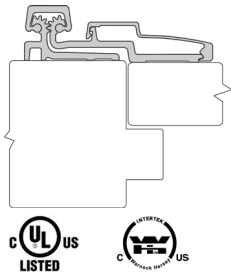

Roton Continuous Geared Hinges

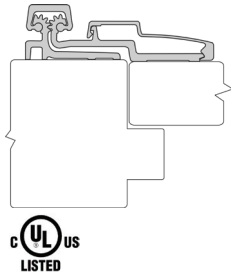

Description	Size	Finish	2022 List	Stock No.	Case Qty.
780-210HD Full Surface Heavy Duty	79" (2007 mm)	Clear	340.82	017046	6
		Dark Bronze	414.35	017037	
		Black	476.52	177093	
	83" (2108 mm)	Clear	340.82	048061	6
		Dark Bronze	414.35	048062	
		Black	476.52	93405	
	85" (2159 mm)	Clear	340.82	024124	6
		Dark Bronze	414.35	071974	
		Black	476.52	-	
95" (2413 mm)	Clear	402.34	048063	6	
	Dark Bronze	495.00	046722		
	Black	569.18	154984		
119" (3023 mm)	Clear	672.94	025722	2	
	Dark Bronze	754.25	000304		
	Black	867.37	165971		

1. U/M is each unless otherwise noted.



Roton Continuous Geared Hinges

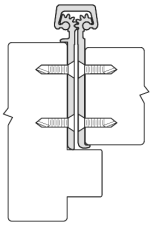

Description	Size	Finish	2022 List	Stock No.	Case Qty.
780-224 Concealed Leaf 1-3/4" Doors Single Pack w/ Drill Quick Screws	79" (2007 mm)	Clear	183.88	183923	7
		Dark Bronze	239.84	194839	
		Black	275.88	-	
	83" (2108 mm)	Clear	183.88	184005	7
		Dark Bronze	239.84	184006	
		Black	275.88	90379	
	95" (2413 mm)	Clear	233.11	184036	7
		Dark Bronze	301.36	194840	
		Black	346.50	198251	
780-224 Bulk Pack Concealed Leaf 1-3/4" Doors Case Pack w/ Drill Quick Screws Must Order Case Quantity					
780-224HD Concealed Leaf 1-3/4" Doors Single Pack w/ Drill Quick Screws	79" (2007 mm)	Clear	229.42	183882	7
		Dark Bronze	297.32	183921	
		Black	343.07	67150	
	83" (2108 mm)	Clear	229.42	184122	7
		Dark Bronze	298.32	183973	
		Black	343.07	183992	
	85" (2159 mm)	Clear	229.42	184012	7
		Dark Bronze	298.32	184014	
		Black	343.07	199457	
	95" (2413 mm)	Clear	277.86	184022	7
		Dark Bronze	365.90	184023	
		Black	420.82	195809	
	119" (3023 mm)	Clear	455.27	184039	5
		Dark Bronze	592.68	194842	
		Black	681.65	195810	
780-224HD Concealed Leaf 1-3/4" Doors Case Pack w/ Drill Quick Screws Must Order Case Quantity					
780-224LL Concealed Leaf 1-3/4" Doors Lead Lined With Half Drill Quick and Half Wood Screws Heavy Duty Profile Only	79" (2007 mm)	Clear	264.92	195181	7
		Dark Bronze	338.05	195221	
		Black	388.87		
	83" (2108 mm)	Clear	264.92	195184	7
		Dark Bronze	338.05	195222	
		Black	388.87	53872	
	85" (2159 mm)	Clear	264.92	195223	7
		Dark Bronze	338.05	-	
		Black	388.87	-	
	95" (2413 mm)	Clear	320.36	195224	7
		Dark Bronze	394.42	195225	
		Black	453.55	-	
	119" (3023 mm)	Clear	503.84	195226	5
		Dark Bronze	649.44	-	
		Black	746.86	-	

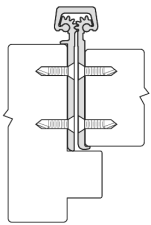
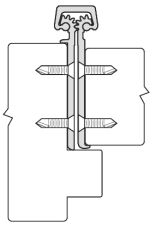

Roton Continuous Geared Hinges

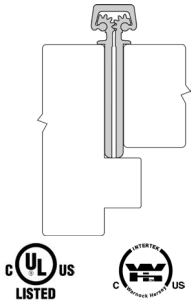

Description	Size	Finish	2022 List	Stock No.	Case Qty.
780-226HD Concealed Leaf Heavy Duty For Doors 2" or Thicker Concealed Leaf Heavy Duty For Doors 2" or Thicker	79" (2007 mm)	Clear	274.43	194843	7
		Dark Bronze	361.94	194844	
		Black	416.33	-	
	83" (2108 mm)	Clear	274.43	183974	7
		Dark Bronze	361.94	194845	
		Black	416.33	195812	
	85" (2159 mm)	Clear	274.43	194846	7
		Dark Bronze	361.94	194849	
		Black	416.33	67532	
95" (2413 mm)	Clear	333.96	184024	7	
	Dark Bronze	429.40	194850		
	Black	493.81	195813		
119" (3023 mm)	Clear	542.39	193587	5	
	Dark Bronze	704.49	194851		
	Black	810.08	195815		

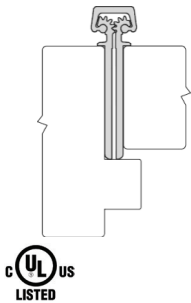

780-226LL Concealed Leaf For Lead Lined Doors 2" or Thicker With Half Drill Quick and Half Wood Screws Heavy Duty Profile Only	79" (2007 mm)	Clear	297.40	195229	7
		Dark Bronze	378.84	195233	
		Black	435.60	-	
	83" (2108 mm)	Clear	297.40	195235	7
		Dark Bronze	378.84	95797	
		Black	435.60	-	
	85" (2159 mm)	Clear	297.40	143304	7
		Dark Bronze	378.84	-	
		Black	435.60	-	
	95" (2413 mm)	Clear	359.44	195236	7
		Dark Bronze	431.90	195237	
		Black	496.72	-	
	119" (3023 mm)	Clear	564.56	195238	5
		Dark Bronze	727.32	195239	
		Black	836.48	-	



Roton Continuous Geared Hinges

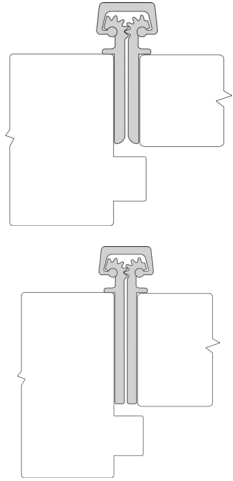

Description	Size	Finish	2022 List	Stock No.	Case Qty.
1200-600XHD Concealed Leaf Extra Heavy Duty For doors from 1-3/4" to 2-3/8" thick.	83" (2108 mm)	Clear	1,382.04	000590	1
		Dark Bronze	1,933.80	028601	
	95" (2413 mm)	Clear	1,565.85	004040	1
		Dark Bronze	2,118.60	065709	
	119" (3023 mm)	Clear	1,750.32	090770	1
		Dark Bronze	2,302.07	107206	
1200-650XHD Concealed Leaf Extra Heavy Duty For doors 2-3/8" thick or thicker.	83" (2108 mm)	Clear	1,842.72	090353	1
		Dark Bronze	2,394.48	135473	
	95" (2413 mm)	Clear	2,026.20	090439	1
		Dark Bronze	2,579.28	108903	
	119" (3023 mm)	Clear	2,211.00	090440	1
		Dark Bronze	2,762.76	044852	