



TEL: 800.BRADLEY
FAX: 262.251.5817
bradleycorp.com

Washroom Accessories List Price Book 0323WAP

Effective Date March 31, 2023

Table of Contents

Introduction	2
Diplomat	3, 4
Multi-Purpose Units	5
Towel-Waste Units	6, 7
Towel Dispensers	8
Hand Dryers	9
Waste Receptacles	10
Napkin/Tampon Vendors & Disposals	11
Toilet Tissue Holders	12, 13
Verge Soap Dispensers	14, 15
Soap Dispensers	16
Mirrors	17-19
Shelves	20
Grab Bars (How to Specify, Configurations, Grab Bars)	21-33
Hospitality	34-37
Healthcare, Shower Seats, Medicine Cabinets, Custodial Accessories	38, 39
Security Accessories	40



Washroom Accessories Division

TEL: 1-800-BRADLEY FAX: 262-251-5817

Web Site: www.bradleycorp.com

Effective Date March 31, 2023

Introduction

PRICES	This price list applies from its effective date. All prior price lists are canceled. Prices are subject to change without notice. Items may be changed or discontinued without notice and without incurring obligation. For job quotations, please contact your Bradley Sales Representative .
CREDIT TERMS	Open account terms are Net within 30 days from date of invoice. Past due accounts may be subject to a service charge. Settlement of past due invoices may be required before additional shipments are made. Cash in advance may be required when an open account is not approved. Our Credit Department phone is 1-800-BRADLEY, FAX (262) 251-7747.
MINIMUM ORDERS	Orders under \$100.00 Net will incur a \$15.00 handling fee.
RETURN MERCHANDISE AUTHORIZATION AND CANCELLATIONS	Please refer to the website link below for further information. http://www.bradleycorp.com/customerservice/rma
SHIPMENTS AND CLAIMS	Shipments will be made by common carrier and are F.O.B. shipping points. Full freight may be prepaid and allowed on shipments of \$5,000.00 Net or more within continental United States for Washroom Accessories only. Transit damage should be noted on the freight bill before signing for receipt of material. Buyer must submit claims for shortages or other errors in delivery in writing to Seller within 10 calendar days after receipt of shipment. Failure to give such notice shall constitute unqualified acceptance and a waiver of all such claims. Bradley will file the claim with the contracted carrier as a service to the customer, if notified within the specified time period. Customer must hold concealed damaged material for inspection by freight carrier. All delivery dates are approximate. Seller shall not be liable for any damage as a result of any delay or failure to deliver due to any cause beyond Seller's reasonable control. In the event of such delay, the date of delivery shall be extended for a period equal to the time lost because of the delay. Claims for shipment shortages must be faxed within two (2) weeks of invoice date to Bradley with documentation and are subject to factory verification. Due to special packaging requirements, all parcel shipments of mirrors will be subject to \$5.00 per mirror surcharge. The fee for insurance on parcel shipments will be included in the amount added for delivery.
BRADEX	Orders consisting of items indicated as BradEX (BX) will ship 3 days after receipt of order. The order can ship same day if entered before noon, and will ship the next day if entered noon or later. There is no pricing penalty for this service. To find out more, please contact your local Bradley Sales Representative.
WARRANTY	Product warranties may be found under "product Information" on our web site at www.bradleycorp.com

**All orders are subject to the terms and conditions found at
<http://www.bradleycorp.com/prodinfo/warranty/index.htm>**





Washroom Accessories Division

TEL: 1-800-BRADLEY FAX: 262-251-5817

Web Site: www.bradleycorp.com

Effective Date March 31, 2023

Diplomat Series

	Model No.	Description	Shipping Data		Price Each \$		
			Cu. Ft.	Wt. Lbs.			
Towel Dispenser/ Waste Receptacle 	2A05	Recessed, Folded Towel, 12 Gallon Capacity	5.90	40.00	\$ 1,029.00	BX	
	2A05-10	Semi-Recessed Model 2A05	5.90	46.70	\$ 1,219.00		
	2A05-11	Surface-Mounted Model 2A05	5.90	50.46	\$ 1,378.00		
	2A05-36	Recessed, Folded Towel, 18 Gallon Capacity	6.74	47.04	\$ 1,079.00		
	2A05-1036	Semi-Recessed Model 2A05-36	6.74	41.90	\$ 1,311.00		
	2A05-1136	Surface-Mounted Model 2A05-36	6.74	44.15	\$ 1,424.00		
	2A15-36	Recessed, Mechanical Pull Roll Towel, 21 Gallon Capacity	10.99	61.50	\$ 1,153.00		
	2A15-1036	Semi-Recessed Model 2A15-36	10.99	71.25	\$ 1,369.00		
	2A15-1136	Surface-Mounted Model 2A15-36	10.99	76.12	\$ 1,435.00		
	2A25-36	Recessed, Sensored Roll Towel, 21 Gallon Capacity	10.99	60.50	\$ 1,215.00		
	2A25-1036	Semi-Recessed Model 2A25-36	10.99	69.00	\$ 1,392.00		
	2A25-1136	Surface-Mounted Model 2A25-36	10.99	73.87	\$ 1,428.00		
	2A95-36	Recessed, Dispenser Not Included, 21 Gallon Capacity	10.99	54.50	\$ 1,092.00		
	2A95-1036	Semi-Recessed Model 2A95-36	10.99	64.25	\$ 1,311.00		
2A95-1136	Surface-Mounted Model 2A95-36	10.99	69.12	\$ 1,349.00			
Towel Dispenser 	2A00	Recessed, Folded Towel	3.40	24.42	\$ 512.00	BX	
	2A00-10	Semi-Recessed Model 2A00	3.40	24.07	\$ 633.00		
	2A10-11	Surface-Mounted Model 2A00	0.59	5.55	\$ 202.00		
	2A01	Recessed, Mechanical Pull Roll Towel	4.67	35.60	\$ 733.00		
	2A01-10	Semi-Recessed Model 2A01	4.67	42.08	\$ 840.00		
	2A01-11	Surface-Mounted Model 2A01	4.67	45.26	\$ 869.00		
	2A02	Recessed, Sensored Roll Towel	4.67	34.60	\$ 802.00		
	2A02-10	Semi-Recessed Model 2A02	4.67	41.08	\$ 909.00		
	2A02-11	Surface-Mounted Model 2A02	4.67	44.26	\$ 937.00		
	2A09	Recessed, Dispenser Not Included	4.67	29.60	\$ 600.00		
	2A09-10	Semi-Recessed Model 2A09	4.67	36.08	\$ 746.00		
2A09-11	Surface-Mounted Model 2A09	4.67	39.26	\$ 730.00			
Waste Receptacle 	3A05	Recessed, 12 Gallon Capacity	3.60	22.00	\$ 513.00	BX	
	3A05-10	Semi-Recessed Model 3A05	3.60	25.66	\$ 549.00		
	3A05-11	Surface-Mounted Model 3A05	3.60	27.87	\$ 563.00		
	3A15-11	Surface-Mounted, 16.5 Gallon Capacity	3.49	19.00	\$ 400.00		BX
	3A05-36	Recessed, 18 Gallon Capacity	5.53	25.00	\$ 629.00		
	3A05-1036	Semi-Recessed Model 3A05-36	5.53	28.00	\$ 710.00		
	3A05-1136	Surface-Mounted Model 3A05-36	5.53	30.00	\$ 763.00		

Prices subject to change without notice.
 Items may be changed or discontinued without notice
 and without incurring obligation.



Washroom Accessories Division

TEL: 1-800-BRADLEY FAX: 262-251-5817
 Web Site: www.bradleycorp.com

Effective Date March 31, 2023

Diplomat Series

	Model No.	Description	Shipping Data		Price Each \$
			Cu. Ft.	Wt. Lbs.	
Napkin/Tampon Vendor 	4A20-40	Recessed w/FREE Mechanism	2.32	25.03	\$ 1,151.00
	4A20-1140	Surface-Mounted Model 4A20-40	2.32	29.91	\$ 1,334.00
	4A20-42	Recessed w/\$.10 Mechanism	2.32	25.03	\$ 1,151.00
	4A20-1142	Surface-Mounted Model 4A20-42	2.32	29.91	\$ 1,334.00
	4A20-45	Recessed w/\$.25 Mechanism	2.32	25.03	\$ 1,151.00
	4A20-1145	Surface-Mounted Model 4A20-45	2.32	29.91	\$ 1,334.00
	4A20-43	Recessed w/\$.50 Mechanism	2.32	25.03	\$ 1,151.00
	4A20-1143	Surface-Mounted Model 4A20-43	2.32	29.91	\$ 1,334.00
	4A20-44	Recessed w/\$1.00 Mechanism	2.32	25.03	\$ 1,151.00
	4A20-1144	Surface-Mounted Model 4A20-44	2.32	29.91	\$ 1,334.00
	Napkin Disposal 	4A00	Recessed, 1.5 Gallon Capacity	0.71	7.25
4A00-10		Semi-Recessed Model 4A00	0.71	7.25	\$ 781.00
4A10-11		Surface-Mounted, 1.5 Gallon Capacity	0.23	2.75	\$ 78.00 BX
4A11		Partition-Mounted, 1.5 Gallon Capacity	0.71	8.05	\$ 473.00
Toilet Tissue Dispenser 	5A00	Recessed, Dual Roll	0.35	4.50	\$ 220.00
	5A10-11	Surface-Mounted, Dual Roll	0.26	4.05	\$ 179.00 BX
	5A20	Partition-Mounted, Dual Roll, Serves Two Compartments	0.76	12.09	\$ 371.00
Seat Cover Dispenser 	5A40-11	Surface-Mounted	0.30	4.55	\$ 171.00 BX
Soap Dispenser 	6A00-11	Surface-Mounted, Sensored Liquid Soap/Gel Sanitizer	0.16	2.7	\$ 232.00 BX
	6A01-11	Surface-Mounted, Sensored Foam Soap/Foam Sanitizer	0.16	2.7	\$ 244.00 BX
	6A02-11	Surface-Mounted, Sensored Liquid Sanitizer	0.16	2.7	\$ 244.00 BX
Soap/Sanitizer Dispenser Stand 	6A20-11	Hand Sanitizer/Soap Dispenser Stand	7.6	12	\$ 232.00

Prices subject to change without notice.
 Items may be changed or discontinued without notice
 and without incurring obligation.



Washroom Accessories Division

TEL: 1-800-BRADLEY FAX: 262-251-5817

Web Site: www.bradleycorp.com

Effective Date March 31, 2023

Series 100 - Multi-Purpose Units

	Model No.	Description	Shipping Data		Price Each \$
			Cu. Ft.	Wt. Lbs.	
	1471	Recessed Soap & Towel Dispenser - Liquid Soap	1.56	8.21	\$ 515.00
	1471-10	Semi-Recessed Soap & Towel Dispenser - Liquid Soap	1.56	10.12	\$ 668.00
	1471-11	Surface-Mtd Soap & Towel Dispenser - Liquid Soap	1.56	11.50	\$ 630.00
	155	Recessed Towel Dispenser, Exterior Shelf, Mirror Door	1.92	19.24	\$ 411.00
	155-10	Semi-Recessed Towel Dispenser, Exterior Shelf, Mirror Door	1.92	23.00	\$ 523.00
	155-11	Surface-Mtd Towel Dispenser, Exterior Shelf, Mirror Door	1.92	24.00	\$ 577.00
	198	Towel Dispenser, Exterior Shelf - Behind Mirror or Wall	1.92	14.29	\$ 390.00
	1981	Towel Dispenser - Behind Mirror or Wall	1.01	7.48	\$ 350.00
	1985	Towel Dispenser, Exterior Shelf - Behind Mirror or Wall	1.92	14.85	\$ 390.00

Prices subject to change without notice.
 Items may be changed or discontinued without notice
 and without incurring obligation.





Washroom Accessories Division

TEL: 1-800-BRADLEY FAX: 262-251-5817

Web Site: www.bradleycorp.com

Effective Date March 31, 2023

Series 200 - Towel Dispenser/Waste Receptacle

	Model No.	Description	Shipping Data		Price Each \$	
			Cu. Ft.	Wt. Lbs.		
	270	Recessed, Multipurpose Unit Towel Dispenser/Hand Dryer/ Waste Receptacle	6.24	52.00	\$1,633.00	
	270-10	Semi-Recessed Model 270	6.24	52.00	\$1,685.00	
	270-11	Surface-Mtd. Model 270	6.24	52.00	\$1,738.00	
	270-49	Recessed, Multipurpose Unit Towel Dispenser/Hand Dryer/ Waste Receptacle, 230V, 50 Hz	6.24	52.00	\$1,633.00	
	270-1049	Semi-Recessed Model 270-49	6.24	52.00	\$1,685.00	
	270-1149	Surface-Mtd. Model 270-49	6.24	52.00	\$1,738.00	
	TOWEL DISPENSER/ WASTE RECEPTACLE 	2017	Recessed, Contemporary Series, 5.75 Gal. Cap.	5.19	38.00	\$ 563.00
2017-10		Semi-Recessed Model 2017	5.19	42.00	\$ 745.00	BX
2017-11		Surface-Mtd. Model 2017	5.19	44.00	\$ 836.00	
2027		Recessed, Contemporary Series, 3.75 Gal. Cap.	3.75	30.15	\$ 551.00	BX
2027-10		Semi-Recessed Model 2027	3.75	34.19	\$ 827.00	
2027-11		Surface-Mtd. Model 2027	3.75	36.99	\$ 788.00	
2037		Recessed, Contemporary Series, 12 Gal. Cap.	5.90	45.51	\$ 851.00	
2037-10		Semi-Recessed Model 2037	5.90	58.00	\$ 1,182.00	
2037-11		Surface-Mtd. Model 2037	5.90	62.00	\$ 1,270.00	
225		Recessed, 10.5 Gal. Cap.	6.92	50.00	\$ 1,031.00	
225-10		Semi-Recessed Model 225	6.92	62.00	\$ 1,292.00	
225-11		Surface-Mtd. Model 225	6.92	66.00	\$ 1,426.00	
-35		Optional Feature: Self-Closing push-flap door			*	
2251		Recessed, 6 Gal. Cap.	5.19	33.56	\$ 766.00	
2251-10		Semi-Recessed Model 2251	5.19	43.00	\$ 1,027.00	
2251-11		Surface-Mtd. Model 2251	5.19	44.00	\$ 1,124.00	
2252		Recessed, 5.75 Gal. Cap.	5.19	35.82	\$ 1,008.00	
2252-10		Semi-Recessed Model 2252	5.19	45.40	\$ 994.00	
2252-11		Surface Mtd Model 2252	5.19	39.40	\$ 1,139.00	
-35		Optional Feature: Self-Closing push-flap door			*	
227		Recessed, 18 Gal. Cap. - Roll Towel	8.27	72.00	\$ 1,002.00	
227-10		Semi-Recessed Model 227 - Roll Towel	8.27	65.00	\$ 1,176.00	
227-11		Surface Mtd Model 227 - Roll Towel	8.27	65.00	\$ 1,311.00	
-35		Optional Feature: Hinged Cover			*	
-65		Optional Feature: Hinged Cover with push flap door			*	
2271		Recessed, 18 Gal. Cap.- Dispenser Not Included	8.27	65.00	\$ 796.00	
2271-10		Semi-Recessed Model 2271- Dispenser Not Included	8.27	70.00	\$ 1,100.00	
2271-11		Surface Mtd Model 2271- Dispenser Not Included	8.27	75.00	\$ 1,269.00	
2277	Recessed, Contemporary Series, 8.6 Gal. Cap.	8.27	52.26	\$ 1,132.00	BX	
2277-10	Semi-Recessed Model 2277	8.27	45.00	\$ 1,365.00		
2277-11	Surface Mtd Model 2277	8.27	45.00	\$ 1,443.00		

Prices subject to change without notice.
Items may be changed or discontinued without notice
and without incurring obligation.



Washroom Accessories Division

TEL: 1-800-BRADLEY FAX: 262-251-5817

Web Site: www.bradleycorp.com

Effective Date March 31, 2023

Series 200 - Towel Dispenser/Waste Receptacle

	Model No.	Description	Shipping Data		Price Each \$	
			Cu. Ft.	Wt. Lbs.		
	229	Recessed, 1.25 Gal. Cap.	0.86	7.28	\$ 342.00	
	229-10	Semi-Recessed Model 229	0.86	9.58	\$ 515.00	
	229-11	Surface Mtd Model 229	0.86	10.53	\$ 432.00	
	2291	Recessed, 2 Gal. Cap.	2.88	12.15	\$ 263.00	BX
	2291-10	Semi-Recessed Model 2291	1.76	15.02	\$ 357.00	
	2291-11	Surface Mtd Model 2291	2.88	16.00	\$ 380.00	BX
	2297	Recessed, Contemporary Series, 2 Gal. Cap.	1.76	18.32	\$ 400.00	BX
	2297-10	Semi-Recessed Model 2297	1.76	21.00	\$ 595.00	
	2297-11	Surface Mtd Model 2297	1.76	22.21	\$ 623.00	
	234	Recessed, 12 Gal. Cap.	6.74	35.61	\$ 494.00	BX
	234-10	Semi-Recessed Model 234	6.74	40.43	\$ 691.00	BX
	234-11	Surface-Mtd. Model 234	6.19	45.00	\$ 683.00	BX
	-35	Optional Feature: Hinged cover			*	
	-36	Optional Feature: Large capacity waste receptacle - 18 gal.			*	
	-65	Optional Feature: Hinged cover with push flap door			*	
	235	Recessed, 4.2 Gal. Cap.	3.75	35.66	\$ 766.00	BX
	235-10	Semi-Recessed Model 235	3.75	38.90	\$ 796.00	
	235-11	Surface-Mtd. Model 235	3.75	44.69	\$ 836.00	
	236	Recessed, Center-pull 12 Gal. Cap.	9.72	46.00	\$ 814.00	
	236-10	Semi-Recessed, Center-pull 12 Gal. Cap.	8.27	55.00	\$ 930.00	
	236-11	Surface-Mtd., Center-pull 12 Gal. Cap.	9.72	59.00	\$ 1,028.00	
	-36	Optional Feature: Large capacity waste receptacle - 18 gal.			*	
	237	Recessed 12 Gal. Cap.	5.90	42.52	\$ 683.00	
	237-10	Semi-Recessed Model 237	5.90	46.57	\$ 869.00	
	237-11	Surface-Mtd. Model 237	5.90	54.00	\$ 900.00	
	-35	Optional Feature: Hinged cover			*	
	-36	Optional Feature: Large capacity waste receptacle - 18 gal.			*	
	-65	Optional Feature: Hinged cover with push flap door			*	
	238	Recessed 8 Gal. Cap.	5.90	41.20	\$ 741.00	
	238-10	Semi-Recessed Model 238	5.90	47.97	\$ 923.00	
238-11	Surface-Mtd. Model 238	5.90	61.00	\$ 1,021.00		

Prices subject to change without notice.
 Items may be changed or discontinued without notice
 and without incurring obligation.



Washroom Accessories Division

TEL: 1-800-BRADLEY FAX: 262-251-5817

Web Site: www.bradleycorp.com

Effective Date March 31, 2023

Series 200 - Towel Dispenser/Combination Units

	Model No.	Description	Shipping Data		Price Ea. \$	
			Cu. Ft.	Wt. Lbs.		
TOWEL DISPENSER 	244	Recessed	2.63	12.02	\$ 426.00	
	244-10	Semi-Recessed Model 244	2.63	16.00	\$ 455.00	
	244-11	Surface-Mtd. Model 244	2.63	16.25	\$ 441.00	
	2441	Recessed	0.59	7.02	\$ 171.00	BX
	2441-10	Semi-Recessed Model 2441	0.56	8.47	\$ 290.00	
	2441-11	Surface-Mtd. Model 2441	0.56	10.00	\$ 306.00	
	2442	Recessed, Contemporary Series	0.86	8.16	\$ 244.00	BX
	2442-10	Semi-Recessed Model 2442	0.86	20.00	\$ 385.00	
	2442-11	Surface-Mtd. Model 2442	0.86	10.00	\$ 455.00	
	2447	Recessed, Contemporary Series	2.63	15.74	\$ 361.00	
	2447-10	Semi-Recessed Model 2447	2.63	21.00	\$ 570.00	
	2447-11	Surface-Mtd. Model 2447	2.63	23.00	\$ 601.00	
	CENTERPULL TOWEL DISPENSER	247	Recessed	2.63	18.00	\$ 455.00
247-10		Semi-Recessed Model 247	2.63	21.00	\$ 577.00	
247-11		Surface-Mtd. Model 247	2.63	26.00	\$ 623.00	
ROLL TOWEL DISPENSER 	2479	Recessed	4.72	19.00	\$ 481.00	
	2479-10	Semi-Recessed, Model 2479	4.72	22.00	\$ 607.00	
	2479-11	Surface Mtd, Model 2479	4.72	18.00	\$ 326.00	
FOLDED TOWEL DISPENSER 	2482-11	Surface-Mtd. Push Bar	1.68	15.00	\$ 429.00	
	2483	Surface-Mtd. Lever	1.68	16.25	\$ 441.00	BX
	2484	Recessed, Lever	4.72	42.00	\$ 826.00	
	2484-10	Semi-Recessed, Lever	4.72	42.00	\$ 880.00	
	2494	Roll Towel Dispenser - Sensored, Surface-Mtd.	1.02	5.40	\$ 211.00	BX
	2495	Roll Towel Dispenser - Lever Operated, Surface-Mtd.	1.30	5.65	\$ 195.00	
	2496	Roll Towel Dispenser - Sensored, Surface-Mtd.	1.02	5.40	\$ 273.00	BX
	2497	Roll Towel Dispenser - Push-Lever Operated, Surface-Mtd.	1.14	4.90	\$ 334.00	BX
FOLDED TOWEL DISPENSER	2498	Roll Towel Dispenser - Sensored, Surface-Mtd., Black ABS Plastic	1.41	7.20	\$ 306.00	BX
	2499 *	Roll Towel Dispenser - Sensored, Surface-Mtd., Stainless Steel	1.41	8.40	\$ 553.00	BX
	250-15 *	Surface-Mtd. (6 per master carton)	0.39	5.08	\$ 81.00	BX
	250-1578	Surface-Mtd., Polished Stainless Steel in lieu of Satin Finish	0.39	5.08	\$ 248.00	
	251-15	Surface-Mtd. (8 per master carton)	3.41	6.00	\$ 165.00	BX
	252	Surface-Mtd. (12 per master carton)	0.23	3.00	\$ 90.00	BX
	250-33	White Enamel, Surface-Mtd.	0.39	3.57	\$ 118.00	
259	Surface-Mtd., Accommodates Roll Paper Towels	0.02	1.53	\$ 39.00		

Notes

For information on options on this page please contact your local Sales Representative or Customer Service

Prices subject to change without notice.
 Items may be changed or discontinued without notice
 and without incurring obligation.





Washroom Accessories Division

TEL: 1-800-BRADLEY FAX: 262-251-5817

Web Site: www.bradleycorp.com

Effective Date March 31, 2023

Series 200 - Electric Dryers

	Model No.	Description	Shipping Data		Price Each \$	
			Cu. Ft.	Wt. Lbs.		
AERIX + HAND DRYER 	2921-S0000H	ABS, Silver, 110-120V, Hard-Wired, Surf-Mtd, ADA, Adj Dry Time	3.22	23.50	\$ 2,400.00	BX
	2921-S000CE	ABS, Silver, 220-240V, Corded, Surf-Mtd, ADA, Adj Dry Time - CE	3.22	23.50	\$ 2,400.00	
	2922-2873	Aluminum, White, 110-120V, Adj Dry Time, Heated, Surf-Mtd	1.08	12.70	\$ 926.00	BX
	2922-2874	SS - Satin, 110-120V, Adj Dry Time, Heated, Surf-Mtd	1.08	14.20	\$ 974.00	BX
	2923-28B001	ADA, High Speed, Aluminum, Black Epoxy Finish	0.90	11.27	\$ 759.00	BX
	2923-28W001	ADA, High Speed, Aluminum, White Epoxy Finish	0.90	11.27	\$ 759.00	BX
	2923-287401	ADA, High Speed, Stainless Steel, Satin Finish	0.92	12.76	\$ 861.00	BX
AERIX HAND DRYER 	2901-2873	Steel, White, Surf-Mtd, Universal Voltage, Adj Dry Time	0.50	10.40	\$ 760.00	BX
	2901-2874	SS - Satin, Surf-Mtd, Universal Voltage, Adj Dry Time	0.50	10.40	\$ 894.00	BX
	2902-28	Cast Iron, White, Surf-Mtd, ADA, Universal Voltage, Adj Dry Time	0.75	15.20	\$ 737.00	BX
	2902-2873	Steel, White, Surf-Mtd, ADA, Universal Voltage, Adj Dry Time	0.75	7.90	\$ 731.00	BX
	2902-2874	SS - Satin, Surf-Mtd, ADA, Universal Voltage, Adj. Dry Time	0.75	7.90	\$ 812.00	BX
	2902-2878	SS - High Polished, Surf-Mtd, ADA, Universal Voltage, Adj. Dry Time	0.75	7.90	\$ 818.00	
	2903-28	Cast Iron, White, Surface-Mtd	1.08	25.35	\$ 684.00	BX
	2903-2800CE	Cast Iron, White, Surface-Mtd, CE - European Export	1.08	25.35	\$ 706.00	
	2904-28	Cast Iron, White, Surface-Mtd	1.08	25.35	\$ 684.00	BX
	2904-2800CE	Cast Iron, White, Surface-Mtd, CE - European Export	1.08	25.35	\$ 706.00	
	2905-2873	Steel, White, Surf-Mtd.	0.91	15.00	\$ 477.00	BX
	2905-2873CE	Steel, White, Surf-Mtd, CE - European Export	0.91	15.00	\$ 477.00	

Prices subject to change without notice.
 Items may be changed or discontinued without notice
 and without incurring obligation.



Washroom Accessories Division

TEL: 1-800-BRADLEY FAX: 262-251-5817
 Web Site: www.bradleycorp.com

Effective Date March 31, 2023

Series 300 - Waste Receptacles

	Model No.	Description	Shipping Data		Price Each \$		
			Cu. Ft.	Wt. Lbs.			
WASTE RECEPTACLES	P10-696	Circular Waste Chute	0.90	1.70	\$ 119.00	BX	
	315-35	Recessed 9.2 Gal. Cap.	4.71	34.63	\$ 680.00		
	315-64	Recessed 9.2 Gal. Cap., No push cover door	4.71	34.23	\$ 1,089.00		
	315-1035	Semi-Recessed 9.2 Gal Cap.	4.71	40.00	\$ 915.00		
	315-1135	Surface-Mtd. 9.2 Gal Cap.	4.71	47.00	\$ 1,050.00		
	315-1164	Surface-Mtd. 9.2 Gal Cap., No push cover door	4.71	44.13	\$ 720.00		
	3157	Recessed 9.2 Gal. Cap.	4.71	40.00	\$ 730.00		
	3157-10	Semi-Recessed 9.2 Gal. Cap.	4.71	41.31	\$ 930.00		
	3157-11	Surface-Mtd. 9.2 Gal. Cap.	4.71	51.00	\$ 1,029.00		
	3251	Recessed, 2.8 Gal. Cap.	2.63	15.30	\$ 380.00		
	3251-10	Semi-Recessed, Model 3251	2.63	23.00	\$ 512.00		
	3251-11	Surface-Mtd. Model 3251	2.63	25.00	\$ 513.00		
	3257	Recessed, Contemporary Series, 2.8 Gal. Cap.	2.63	19.26	\$ 380.00		
	3257-10	Semi-Recessed, Contemporary Series, 2.8 Gal. Cap.	2.63	26.00	\$ 418.00		
	3257-11	Surface-Mtd., Contemporary Series, 2.8 Gal. Cap.	2.63	28.00	\$ 426.00		
	334	Recessed, 18 Gal. Cap.	3.48	25.00	\$ 408.00		BX
	334-10	Semi-Recessed, 18 Gal. Cap.	3.48	41.00	\$ 483.00		
	334-11	Surface-Mtd. Model 334	3.48	43.00	\$ 546.00		
	-35	Optional Feature: Hinged Cover	0.00	1.00	*		BX
	-65	Optional Feature: Hinged Cover with push flap door	0.00	2.00	*		
	344	Recessed, 12 Gal. Cap.	3.40	22.20	\$ 365.00		
	344-10	Semi-Recessed Model 344	3.40	24.07	\$ 364.00		BX
	344-11	Surface-Mtd. Model 344	3.40	24.72	\$ 472.00		
	-35	Optional Feature: Hinged Cover	0.00	1.00	*		
	-65	Optional Feature: Hinged Cover with push flap door	0.00	2.00	*		BX
	346	Recessed, 12 Gal. Cap.	3.40	33.00	\$ 422.00		
	346-10	Semi-Recessed Model 346	3.40	41.00	\$ 594.00		
	346-11	Surface-Mtd. Model 346	3.40	28.14	\$ 582.00		BX
	-35	Optional Feature: Hinged Cover	0.00	1.00	*		
	-65	Optional Feature: Hinged Cover with push flap door	0.00	2.00	*		
	355	Surface-Mtd. 20.6 Gal. Cap.	3.74	15.91	\$ 275.00		BX
	355-35	Surface-Mtd. 20.6 Gal. Cap. w/Hinged Cover	3.74	16.91	\$ 394.00		
	355-65	Surface-Mtd. w/Hinged Cover & push flap door	3.74	17.91	\$ 420.00		
356	Surface-Mtd. 16.5 Gal. Cap.	3.31	14.59	\$ 255.00	BX		
356-35	Surface-Mtd. 16.5 Gal. Cap. w/Hinged Cover	3.31	15.59	\$ 304.00			
3565	Surface-Mtd. 12 Gal. Cap.	3.16	13.60	\$ 270.00			
357	Surface-Mtd. 6.5 Gal. Cap.	1.05	7.74	\$ 146.00	BX		
357-35	Surface-Mtd. 6.5 Gal. Cap. w/Hinged Cover	1.05	8.74	\$ 241.00			
369-11	Surface-Mtd. 1.7 Gal. Cap.	2.97	7.69	\$ 817.00		BX	
377	Freestanding, 13 Gal. Cap.	2.80	17.00	\$ 485.00			
377-37	Freestanding, 13 Gal. Cap., Less Swing Top	4.95	9.80	\$ 273.00			
377-36	Freestanding, 21 Gal. Cap.	4.66	22.70	\$ 621.00	BX		
377-3637	Freestanding, 21 Gal. Cap., Less Swing Top	4.95	18.45	\$ 412.00			
377-38	Freestanding, 36 Gal. Cap.	7.01	31.80	\$ 754.00			
377-3738	Freestanding, 36 Gal. Cap., Less Swing Top	7.30	25.00	\$ 512.00			



Notes *For information on options on this page please contact your local Sales Representative or Customer Service

Prices subject to change without notice.
 Items may be changed or discontinued without notice
 and without incurring obligation.



Washroom Accessories Division

TEL: 1-800-BRADLEY FAX: 262-251-5817

Web Site: www.bradleycorp.com

Effective Date March 31, 2023

Series 400 - Napkin/Tampon Vendors & Disposals

	Model No.	Description	Shipping Data		Price Ea. \$	
			Cu. Ft.	Wt. Lbs.		
NAPKIN/TAMPON VENDOR	401	Recessed or Semi-Recessed, 30 Napkins-28 Tampons (specify coinage)			*	
	401-40	401 with Free Mechanism	2.32	25.00	\$ 683.00	
	401-42	401 with 10¢ Mechanism	2.32	25.11	\$ 717.00	
	401-43	401 with 50¢ Mechanism	2.32	25.12	\$ 683.00	
	401-45	401 with 25¢ Mechanism	2.32	25.22	\$ 683.00	BX
	4017	Recessed, Contemporary Series, 30 Napkins-28 Tampons (specify coinage)			*	
	4017-40	4017 with Free Mechanism	2.32	24.00	\$ 759.00	
	4017-42	4017 with 10¢ Mechanism	2.32	24.62	\$ 759.00	
	4017-43	4017 with 50¢ Mechanism	2.32	25.14	\$ 759.00	
	4017-45	4017 with 25¢ Mechanism	2.32	24.81	\$ 759.00	
	4017-10	Semi-Recessed, Model 4017 (specify coinage)			*	
	4017-1040	4017-10 with Free Mechanism	2.32	28.17	\$ 840.00	
	4017-1042	4017-10 with 10¢ Mechanism	2.32	28.15	\$ 840.00	
	4017-1043	4017-10 with 50¢ Mechanism	2.32	28.27	\$ 840.00	
	4017-1045	4017-10 with 25¢ Mechanism	2.32	28.04	\$ 840.00	
	4017-11	Surface-Mtd., Model 4017 (specify coinage)			*	
	4017-1140	4017-11 with Free Mechanism	2.21	30.44	\$ 869.00	
	4017-1142	4017-11 with 10¢ Mechanism	2.21	30.44	\$ 869.00	
	4017-1143	4017-11 with 50¢ Mechanism	2.21	30.44	\$ 869.00	
	4017-1144	4017-11 with \$1 Mechanism	2.34	30.58	\$ 869.00	
	4017-1145	4017-11 with 25¢ Mechanism	2.32	30.58	\$ 869.00	
	407	Recessed., (specify coinage)			*	
	407-40	407 with Free Mechanism	1.30	22.76	\$ 735.00	
	407-42	407 with 10¢ Mechanism	1.31	21.85	\$ 727.00	
	407-43	407 with 50¢ Mechanism	1.30	22.76	\$ 727.00	
407-44	407 with \$1 Mechanism	1.30	22.76	\$ 727.00		
407-45	407 with 25¢ Mechanism	1.30	22.76	\$ 727.00	BX	
407-11	Surface-Mtd., (specify coinage)			*		
407-1140	407-11 with Free Mechanism	2.35	30.58	\$ 941.00		
407-1142	407-11 with 10¢ Mechanism	2.35	30.58	\$ 941.00		
407-1143	407-11 with 50¢ Mechanism	2.35	30.58	\$ 941.00		
407-1144	407-11 with \$1 Mechanism	2.35	30.58	\$ 957.00		
407-1145	407-11 with 25¢ Mechanism	2.35	30.58	\$ 957.00	BX	
Vendor Option	-78	Polished Stainless Steel in lieu of Satin Finish	0.00	0.00	*	
NAPKIN DISPOSAL	4721-15	Partition Mtd. Dual Use, 1.5 Gal. Cap.	0.56	9.07	\$ 241.00	BX
	4722-15	Surface-Mtd., for End Compartment, 1.5 Gal. Cap.	0.56	7.60	\$ 148.00	BX
	4722-1015	Semi-Recessed Model 4722-15	0.56	8.39	\$ 216.00	
	4731-15	Recessed	0.56	8.52	\$ 190.00	BX
	4737	Recessed, Contemporary Series, 1.5 Gal. Cap.	0.93	9.65	\$ 324.00	
	4737-10	Semi-Recessed Model 4737	0.93	12.00	\$ 492.00	
	4737-11	Surface-Mtd. Model 4737	0.93	13.00	\$ 514.00	
	4781-11	Surface-Mtd. (6 per master carton)	1.75	3.20	\$ 55.00	BX
	4791-11	Surface-Mtd., With Shelf	0.54	4.00	\$ 101.00	

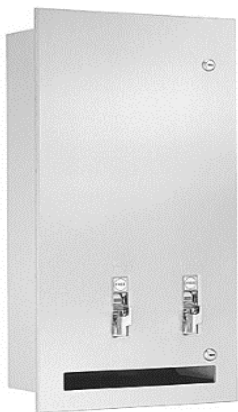

Prices subject to change without notice.
Items may be changed or discontinued without notice
and without incurring obligation.





Washroom Accessories Division

TEL: 1-800-BRADLEY FAX: 262-251-5817

Web Site: www.bradleycorp.com

Effective Date March 31, 2023

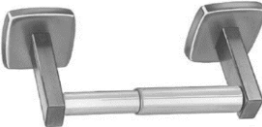
Series 500 - Toilet Tissue Holders

	Model No.	Description	Shipping Data		Price Ea. \$	
			Cu. Ft.	Wt. Lbs.		
	SINGLE ROLL TOILET TISSUE HOLDER	505 Surface-Mtd., Die Cast Zinc	0.03	1.02	\$ 24.00	BX
		5053 Surface-Mtd., Aluminum	0.02	0.35	\$ 64.00	
		5054 Surface-Mtd., Chrome Plated Steel	0.05	0.69	\$ 21.00	BX
		5061 Surface-Mtd., Bright Polish	0.06	1.16	\$ 42.00	
		5071 Surface-Mtd., Controlled Delivery, Aluminum	0.03	0.58	\$ 19.00	BX
		5071-50 Surface-Mtd., Non-controlled Delivery, Aluminum	0.02	0.66	\$ 19.00	BX
		508* Surface-Mtd., Chrome Plated Brass	0.03	1.08	\$ 39.00	BX
		508-32 Surface-Mtd., Die Cast Zinc	0.02	0.64	\$ 13.00	BX
		5084* Surface-Mtd., Satin Stainless Steel	0.03	0.57	\$ 23.00	BX
		5085* Surface-Mtd., Bright Polish	0.06	0.48	\$ 24.00	BX
		5102* Recessed, Bright Finish Stainless Steel Housing	0.10	0.88	\$ 32.00	
		5103* Recessed, With Hood	0.03	1.09	\$ 55.00	
		5104* Recessed, Satin Finish Stainless Steel Housing*	0.10	0.87	\$ 32.00	BX
	5106* Surface-Mtd., with Hood, Bright Polish	0.12	1.55	\$ 59.00	BX	
	5107* Surface-Mtd., with Hood, Satin Finish	0.12	1.55	\$ 59.00		
	DOUBLE ROLL TOILET TISSUE HOLDER	5105 Recessed, Roll in Reserve	0.23	1.27	\$ 66.00	
		5123* Recessed, Bright Polish, With Hood	0.18	2.11	\$ 116.00	
		5124* Recessed, Satin Stainless Steel (See Options)	0.30	2.00	\$ 71.00	BX
		5125* Recessed, Bright Polish (See Options)	0.30	2.01	\$ 71.00	
		5126* Surface Mtd, with Hood, Bright Polish	0.23	3.50	\$ 116.00	BX
		5127 Recessed, Vertical Orientation, Bright Polish Stainless Steel, With Hood	0.23	2.51	\$ 92.00	BX
		522 Surface Mtd, Die Cast Zinc	0.08	1.61	\$ 31.00	BX
		5224 Surface Mtd, Chrome Plated Steel	0.09	1.37	\$ 32.00	BX
		523 Surface Mtd, Die Cast Zinc	0.07	1.00	\$ 32.00	
		5234* Surface Mtd, Satin Stainless Steel	0.04	0.87	\$ 34.00	BX
		5235* Surface Mtd, Bright Polish	0.04	0.87	\$ 37.00	BX
		5241 Surface Mtd, Controlled Delivery, Aluminum	0.06	1.20	\$ 28.00	BX
		5241-50 Non-controlled Delivery ADA Approved, Aluminum	0.06	1.07	\$ 28.00	BX
		5262 Surface Mtd, Single w/Shelf	0.26	3.00	\$ 109.00	
		5263* Surface Mtd, Double w/Shelf	0.26	3.40	\$ 97.00	BX
		5402 Surface-Mtd. (8 per master carton)	0.22	3.90	\$ 95.00	BX
		5412 Recessed (6 per master carton)	0.36	5.56	\$ 158.00	BX
	5422 Partition Mtd.	0.76	10.99	\$ 371.00	BX	
	5424 Surface-Mtd., Single Jumbo Roll (10")	3.04	5.00	\$ 80.00	BX	
	5425 Surface-Mtd., Double Jumbo Roll (9")	1.06	9.00	\$ 238.00	BX	
	5426-11 Surface-Mtd., Jumbo Dual Coreless Roll (9")	1.18	7.84	\$ 759.00	BX	
OPTIONS	-52 Anti-theft spindle		0.00	0.00	*	
	-55 Back clamp for gypsum wallboard mounting		0.00	0.00	*	
	-US Domestic		0.00	0.00	*	

Notes

*For information on options on this page please contact your local Sales Representative or Customer Service

Prices subject to change without notice.
Items may be changed or discontinued without notice and without incurring obligation.



Washroom Accessories Division

TEL: 1-800-BRADLEY FAX: 262-251-5817
 Web Site: www.bradleycorp.com

Effective Date March 31, 2023

Series 500 - Toilet Tissue Holders

	Model No.	Description	Shipping Data		Price Ea. \$	
			Cu. Ft.	Wt. Lbs.		
FOLDED TOILET TISSUE DISPENSER	515	Surface-Mtd., Stainless Steel	0.10	1.58	\$ 39.00	
SEAT COVER DISPENSERS	582	Recessed, Partition mounted	0.96	8.87	\$ 432.00	
	583	Surface-Mtd.	0.52	4.66	\$ 128.00	BX
	5831	Surface-Mtd.	0.51	2.80	\$ 61.00	BX
	5831-78	Surface-Mtd., Polished Stainless Steel in lieu of Satin Finish	0.51	2.80	\$ 191.00	
	584	Recessed	0.52	4.78	\$ 143.00	BX
	5847	Recessed, Contemporary Series	0.86	7.35	\$ 242.00	BX
	5847-78	Recessed, Contemporary Series, Polished Stainless Steel	0.86	7.35	\$ 384.00	
IN-STALL COMBINATION UNITS	591	Partition Mtd.	3.38	27.56	\$ 684.00	BX
	5911	Partition Mtd.	2.00	25.40	\$ 688.00	
	5911-69	Partition Mtd., reverse door	2.00	25.40	\$ 880.00	
	5912	Recessed	2.00	20.66	\$ 535.00	BX
	5912-10	Semi-Recessed	3.45	22.00	\$ 644.00	
	5912-11	Surface-Mtd.	3.38	20.81	\$ 674.00	
	5912-69	Recessed, reverse door	3.38	20.70	\$ 745.00	
	5912-1169	Surface-Mtd., reverse door	3.70	20.81	\$ 715.00	
	592	Partition Mtd.	3.38	25.21	\$ 609.00	
	5921	Partition Mtd.	2.00	22.99	\$ 625.00	
	5921-69	Partition Mtd., reverse door	2.00	22.99	\$ 644.00	
	5922	Recessed	2.00	19.16	\$ 496.00	BX
	5922-10	Semi-Recessed	2.00	22.25	\$ 577.00	
	5922-11	Surface-Mtd.	2.00	17.79	\$ 623.00	
	5922-69	Recessed, reverse door	2.00	19.16	\$ 538.00	
	5922-1069	Semi-Recessed, reverse door	2.00	22.25	\$ 668.00	
	5922-1169	Surface-Mtd., reverse door	3.70	17.79	\$ 637.00	
	5932	Recessed	2.00	19.94	\$ 745.00	
	5932-10	Semi-Recessed	3.45	27.00	\$ 643.00	
	5932-11	Surface-Mtd.	2.03	29.00	\$ 690.00	
	594	Partition Mtd.	3.38	21.85	\$ 615.00	
	5941	Partition Mtd.	2.00	21.50	\$ 661.00	
	5942	Recessed	2.00	16.00	\$ 502.00	
	5942-10	Semi-Recessed	3.45	19.75	\$ 538.00	
	5942-11	Surface-Mtd.	2.00	16.04	\$ 462.00	
	5942-69	Recessed, reverse door	2.11	14.90	\$ 515.00	
	5942-1169	Surface-Mtd., reverse door	2.00	16.04	\$ 563.00	
	5951	Recessed	3.40	27.13	\$ 1,605.00	
	5952	Recessed	3.40	27.13	\$ 1,605.00	
	5961	Recessed, Horizontal	0.91	19.56	\$ 650.00	BX
	5961-11	Surface-Mtd., Horizontal	0.91	19.56	\$ 789.00	
	5962	Recessed, Horizontal	0.91	19.56	\$ 650.00	BX
	5962-11	Surface-Mtd., Horizontal	0.91	19.56	\$ 789.00	



Prices subject to change without notice.
 Items may be changed or discontinued without notice
 and without incurring obligation.





Effective Date March 31, 2023

Verge® Deck Mounted Soap Dispensers - Top Fill

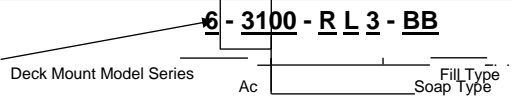
For a hassle-free configuration experience, visit Bradley's "Q20" and type in the soap and deck mount model series when quoting or in the search box.

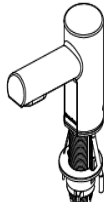

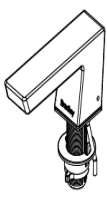
Series	Part No.	Description	Shipping Data		Price Each \$	
			Cu. Ft.	Wt. Lbs.		
CRESTT SERIES 	6-3100-RFT-BB	Crestt Deck Mounted Soap Dispenser Auto Foam Top Fill Brushed Black SS	0.68	4.5	\$578.00	
	6-3100-RFT-BN	Crestt Deck Mounted Soap Dispenser Auto Foam Top Fill Brushed Nickel	0.68	4.5	\$578.00	
	6-3100-RFT-BR	Crestt Deck Mounted Soap Dispenser Auto Foam Top Fill Brushed Brass	0.68	4.5	\$578.00	
	6-3100-RFT-BS	Crestt Deck Mounted Soap Dispenser Auto Foam Top Fill Brushed SS	0.68	4.5	\$578.00	
	6-3100-RFT-BZ	Crestt Deck Mounted Soap Dispenser Auto Foam Top Fill Brushed Bronze	0.68	4.5	\$578.00	
	6-3100-RFT-PC	Crestt Deck Mounted Soap Dispenser Auto Foam Top Fill Polished Chrome	0.68	4.5	\$503.00	
	6-3100-RLT-BB	Crestt Deck Mounted Soap Dispenser Auto Liquid Top Fill Brushed Black SS	0.68	4.5	\$578.00	
	6-3100-RLT-BN	Crestt Deck Mounted Soap Dispenser Auto Liquid Top Fill Brushed Nickel	0.68	4.5	\$578.00	
	6-3100-RLT-BR	Crestt Deck Mounted Soap Dispenser Auto Liquid Top Fill Brushed Brass	0.68	4.5	\$578.00	
	6-3100-RLT-BS	Crestt Deck Mounted Soap Dispenser Auto Liquid Top Fill Brushed SS	0.68	4.5	\$578.00	
	6-3100-RLT-BZ	Crestt Deck Mounted Soap Dispenser Auto Liquid Top Fill Brushed Bronze	0.68	4.5	\$578.00	
	6-3100-RLT-PC	Crestt Deck Mounted Soap Dispenser Auto Liquid Top Fill Polished Chrome	0.68	4.5	\$503.00	
METRO SERIES 	6-3300-RFT-BB	Metro Deck Mounted Soap Dispenser Auto Foam Top Fill Brushed Black SS	0.68	4.375	\$593.00	
	6-3300-RFT-BN	Metro Deck Mounted Soap Dispenser Auto Foam Top Fill Brushed Nickel	0.68	4.375	\$593.00	
	6-3300-RFT-BR	Metro Deck Mounted Soap Dispenser Auto Foam Top Fill Brushed Brass	0.68	4.375	\$593.00	
	6-3300-RFT-BZ	Metro Deck Mounted Soap Dispenser Auto Foam Top Fill Brushed SS	0.68	4.375	\$593.00	
	6-3300-RFT-BZ	Metro Deck Mounted Soap Dispenser Auto Foam Top Fill Brushed Bronze	0.68	4.375	\$593.00	
	6-3300-RFT-PC	Metro Deck Mounted Soap Dispenser Auto Foam Top Fill Polished Chrome	0.68	4.375	\$514.00	
	6-3300-RLT-BB	Metro Deck Mounted Soap Dispenser Auto Liquid Top Fill Brushed Black SS	0.68	4.375	\$593.00	
	6-3300-RLT-BN	Metro Deck Mounted Soap Dispenser Auto Liquid Top Fill Brushed Nickel	0.68	4.375	\$593.00	
	6-3300-RLT-BR	Metro Deck Mounted Soap Dispenser Auto Liquid Top Fill Brushed Brass	0.68	4.375	\$593.00	
	6-3300-RLT-BS	Metro Deck Mounted Soap Dispenser Auto Liquid Top Fill Brushed SS	0.68	4.375	\$593.00	
	6-3300-RLT-BZ	Metro Deck Mounted Soap Dispenser Auto Liquid Top Fill Brushed Bronze	0.68	4.375	\$593.00	
	6-3300-RLT-PC	Metro Deck Mounted Soap Dispenser Auto Liquid Top Fill Polished Chrome	0.68	4.375	\$514.00	
LINEA SERIES 	6-3500-RFT-BB	Linea Deck Mounted Soap Dispenser Auto Foam Top Fill Brushed Black SS	0.68	4.5	\$603.00	
	6-3500-RFT-BN	Linea Deck Mounted Soap Dispenser Auto Foam Top Fill Brushed Nickel	0.68	4.5	\$603.00	
	6-3500-RFT-BR	Linea Deck Mounted Soap Dispenser Auto Foam Top Fill Brushed Brass	0.68	4.5	\$603.00	
	6-3500-RFT-BS	Linea Deck Mounted Soap Dispenser Auto Foam Top Fill Brushed SS	0.68	4.5	\$603.00	
	6-3500-RFT-BZ	Linea Deck Mounted Soap Dispenser Auto Foam Top Fill Brushed Bronze	0.68	4.5	\$603.00	
	6-3500-RFT-PC	Linea Deck Mounted Soap Dispenser Auto Foam Top Fill Polished Chrome	0.68	4.5	\$525.00	
	6-3500-RLT-BB	Linea Deck Mounted Soap Dispenser Auto Liquid Top Fill Brushed Black SS	0.68	4.5	\$603.00	
	6-3500-RLT-BN	Linea Deck Mounted Soap Dispenser Auto Liquid Top Fill Brushed Nickel	0.68	4.5	\$603.00	
	6-3500-RLT-BR	Linea Deck Mounted Soap Dispenser Auto Liquid Top Fill Brushed Brass	0.68	4.5	\$603.00	
	6-3500-RLT-BS	Linea Deck Mounted Soap Dispenser Auto Liquid Top Fill Brushed SS	0.68	4.5	\$603.00	
	6-3500-RLT-BZ	Linea Deck Mounted Soap Dispenser Auto Liquid Top Fill Brushed Bronze	0.68	4.5	\$603.00	
	6-3500-RLT-PC	Linea Deck Mounted Soap Dispenser Auto Liquid Top Fill Polished Chrome	0.68	4.5	\$525.00	
ZEN SERIES 	6-3700-RFT-BB	Zen Deck Mounted Soap Dispenser Auto Foam Top Fill Brushed Black SS	0.68	4.5	\$613.00	
	6-3700-RFT-BN	Zen Deck Mounted Soap Dispenser Auto Foam Top Fill Brushed Nickel	0.68	4.5	\$613.00	
	6-3700-RFT-BR	Zen Deck Mounted Soap Dispenser Auto Foam Top Fill Brushed Brass	0.68	4.5	\$613.00	
	6-3700-RFT-BS	Zen Deck Mounted Soap Dispenser Auto Foam Top Fill Brushed SS	0.68	4.5	\$613.00	
	6-3700-RFT-BZ	Zen Deck Mounted Soap Dispenser Auto Foam Top Fill Brushed Bronze	0.68	4.5	\$613.00	
	6-3700-RFT-PC	Zen Deck Mounted Soap Dispenser Auto Foam Top Fill Polished Chrome	0.68	4.5	\$534.00	
	6-3700-RLT-BB	Zen Deck Mounted Soap Dispenser Auto Liquid Top Fill Brushed Black SS	0.68	4.5	\$613.00	
	6-3700-RLT-BN	Zen Deck Mounted Soap Dispenser Auto Liquid Top Fill Brushed Nickel	0.68	4.5	\$613.00	
	6-3700-RLT-BR	Zen Deck Mounted Soap Dispenser Auto Liquid Top Fill Brushed Brass	0.68	4.5	\$613.00	
	6-3700-RLT-BS	Zen Deck Mounted Soap Dispenser Auto Liquid Top Fill Brushed SS	0.68	4.5	\$613.00	
	6-3700-RLT-BZ	Zen Deck Mounted Soap Dispenser Auto Liquid Top Fill Brushed Bronze	0.68	4.5	\$613.00	
	6-3700-RLT-PC	Zen Deck Mounted Soap Dispenser Auto Liquid Top Fill Polished Chrome	0.68	4.5	\$534.00	
ADDITIONAL REQUIRED PARTS INCLUDED W/ EACH SOAP DISPENSER						
POWER SUPPLY	A14-029	AC Adapter - Electrical Plug Type B (one per faucet)				\$25.00
	A14-030	Battery Pack (includes 4x D-cell batteries)				\$51.00
	A14-031	AC Adapter Splitter Assembly accommodates up to 4 devices when desiring a combination of multiple devices *faucet, soap, & multi-feed soap tank assembly) and/or stations. (Electrical Plug Type B)				\$171.00

Prices subject to change without notice.
Items may be changed or discontinued without notice and without incurring obligation.





Effective Date March 31, 2023

Verge® Deck Mounted Soap Dispensers - Multi-Feed

For a hassle-free configuration experience, visit Bradley's "Q20" and type in the soap and deck mount model series when quoting or in the search box.

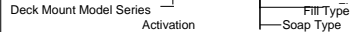
6-3100 - R L 3 - BB

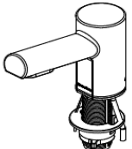
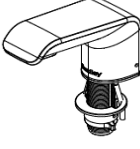
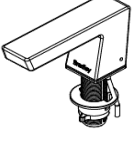

Series	Part No.	Description	Shipping Data		Price Each \$	
			Cu. Ft.	Wt. Lbs.		
 CRESTT SERIES	6-3100-RFM-BB	Crestt Deck Mounted Soap Dispenser Auto Foam Multi-Feed Brushed Black SS	0.68	4.5	\$464.00	
	6-3100-RFM-BN	Crestt Deck Mounted Soap Dispenser Auto Foam Multi-Feed Brushed Nickel	0.68	4.5	\$464.00	
	6-3100-RFM-BR	Crestt Deck Mounted Soap Dispenser Auto Foam Multi-Feed Brushed Brass	0.68	4.5	\$464.00	
	6-3100-RFM-BZ	Crestt Deck Mounted Soap Dispenser Auto Foam Multi-Feed Brushed Bronze	0.68	4.5	\$464.00	
	6-3100-RFM-PC	Crestt Deck Mounted Soap Dispenser Auto Foam Multi-Feed Polished Chrome	0.68	4.5	\$403.00	
	6-3100-RLM-BB	Crestt Deck Mounted Soap Dispenser Auto Liquid Multi-Feed Brushed Black SS	0.68	4.5	\$464.00	
	6-3100-RLM-BN	Crestt Deck Mounted Soap Dispenser Auto Liquid Multi-Feed Brushed Nickel	0.68	4.5	\$464.00	
	6-3100-RLM-BR	Crestt Deck Mounted Soap Dispenser Auto Liquid Multi-Feed Brushed Brass	0.68	4.5	\$464.00	
	6-3100-RLM-BZ	Crestt Deck Mounted Soap Dispenser Auto Liquid Multi-Feed Brushed SS	0.68	4.5	\$464.00	
	6-3100-RLM-PC	Crestt Deck Mounted Soap Dispenser Auto Liquid Multi-Feed Polished Chrome	0.68	4.5	\$403.00	
	 METRO SERIES	6-3300-RFM-BB	Metro Deck Mounted Soap Dispenser Auto Foam Multi-Feed Brushed Black SS	0.68	4.38	\$476.00
		6-3300-RFM-BN	Metro Deck Mounted Soap Dispenser Auto Foam Multi-Feed Brushed Nickel	0.68	4.38	\$476.00
6-3300-RFM-BR		Metro Deck Mounted Soap Dispenser Auto Foam Multi-Feed Brushed Brass	0.68	4.38	\$476.00	
6-3300-RFM-BS		Metro Deck Mounted Soap Dispenser Auto Foam Multi-Feed Brushed SS	0.68	4.38	\$476.00	
6-3300-RFM-BZ		Metro Deck Mounted Soap Dispenser Auto Foam Multi-Feed Brushed Bronze	0.68	4.38	\$476.00	
6-3300-RFM-PC		Metro Deck Mounted Soap Dispenser Auto Foam Multi-Feed Polished Chrome	0.68	4.38	\$415.00	
6-3300-RLM-BB		Metro Deck Mounted Soap Dispenser Auto Liquid Multi-Feed Brushed Black SS	0.68	4.38	\$476.00	
6-3300-RLM-BN		Metro Deck Mounted Soap Dispenser Auto Liquid Multi-Feed Brushed Nickel	0.68	4.38	\$476.00	
6-3300-RLM-BR		Metro Deck Mounted Soap Dispenser Auto Liquid Multi-Feed Brushed Brass	0.68	4.38	\$476.00	
6-3300-RLM-BS		Metro Deck Mounted Soap Dispenser Auto Liquid Multi-Feed Brushed SS	0.68	4.38	\$476.00	
6-3300-RLM-BZ		Metro Deck Mounted Soap Dispenser Auto Liquid Multi-Feed Brushed Bronze	0.68	4.38	\$476.00	
6-3300-RLM-PC		Metro Deck Mounted Soap Dispenser Auto Liquid Multi-Feed Polished Chrome	0.68	4.38	\$415.00	
 LINEA SERIES	6-3500-RFM-BB	Linea Deck Mounted Soap Dispenser Auto Foam Multi-Feed Brushed Black SS	0.68	4.5	\$484.00	
	6-3500-RFM-BN	Linea Deck Mounted Soap Dispenser Auto Foam Multi-Feed Brushed Nickel	0.68	4.5	\$484.00	
	6-3500-RFM-BR	Linea Deck Mounted Soap Dispenser Auto Foam Multi-Feed Brushed Brass	0.68	4.5	\$484.00	
	6-3500-RFM-BS	Linea Deck Mounted Soap Dispenser Auto Foam Multi-Feed Brushed SS	0.68	4.5	\$484.00	
	6-3500-RFM-BZ	Linea Deck Mounted Soap Dispenser Auto Foam Multi-Feed Brushed Bronze	0.68	4.5	\$484.00	
	6-3500-RFM-PC	Linea Deck Mounted Soap Dispenser Auto Foam Multi-Feed Polished Chrome	0.68	4.5	\$421.00	
	6-3500-RLM-BB	Linea Deck Mounted Soap Dispenser Auto Liquid Multi-Feed Brushed Black SS	0.68	4.5	\$484.00	
	6-3500-RLM-BN	Linea Deck Mounted Soap Dispenser Auto Liquid Multi-Feed Brushed Nickel	0.68	4.5	\$484.00	
	6-3500-RLM-BR	Linea Deck Mounted Soap Dispenser Auto Liquid Multi-Feed Brushed Brass	0.68	4.5	\$484.00	
	6-3500-RLM-BS	Linea Deck Mounted Soap Dispenser Auto Liquid Multi-Feed Brushed SS	0.68	4.5	\$484.00	
	6-3500-RLM-BZ	Linea Deck Mounted Soap Dispenser Auto Liquid Multi-Feed Brushed Bronze	0.68	4.5	\$484.00	
	6-3500-RLM-PC	Linea Deck Mounted Soap Dispenser Auto Liquid Multi-Feed Polished Chrome	0.68	4.5	\$421.00	
 ZEN SERIES	6-3700-RFM-BB	Zen Deck Mounted Soap Dispenser Auto Foam Multi-Feed Brushed Black SS	0.68	4.5	\$492.00	
	6-3700-RFM-BN	Zen Deck Mounted Soap Dispenser Auto Foam Multi-Feed Brushed Nickel	0.68	4.5	\$492.00	
	6-3700-RFM-BR	Zen Deck Mounted Soap Dispenser Auto Foam Multi-Feed Brushed Brass	0.68	4.5	\$492.00	
	6-3700-RFM-BS	Zen Deck Mounted Soap Dispenser Auto Foam Multi-Feed Brushed SS	0.68	4.5	\$492.00	
	6-3700-RFM-BZ	Zen Deck Mounted Soap Dispenser Auto Foam Multi-Feed Brushed Bronze	0.68	4.5	\$492.00	
	6-3700-RFM-PC	Zen Deck Mounted Soap Dispenser Auto Foam Multi-Feed Polished Chrome	0.68	4.5	\$428.00	
	6-3700-RLM-BB	Zen Deck Mounted Soap Dispenser Auto Liquid Multi-Feed Brushed Black SS	0.68	4.5	\$492.00	
	6-3700-RLM-BN	Zen Deck Mounted Soap Dispenser Auto Liquid Multi-Feed Brushed Nickel	0.68	4.5	\$492.00	
	6-3700-RLM-BR	Zen Deck Mounted Soap Dispenser Auto Liquid Multi-Feed Brushed Brass	0.68	4.5	\$492.00	
	6-3700-RLM-BS	Zen Deck Mounted Soap Dispenser Auto Liquid Multi-Feed Brushed SS	0.68	4.5	\$492.00	
	6-3700-RLM-BZ	Zen Deck Mounted Soap Dispenser Auto Liquid Multi-Feed Brushed Bronze	0.68	4.5	\$492.00	
	6-3700-RLM-PC	Zen Deck Mounted Soap Dispenser Auto Liquid Multi-Feed Polished Chrome	0.68	4.5	\$428.00	
ADDITIONAL REQUIRED PARTS FOR PURCHASE (purchased separately)						
POWER SUPPLY	A14-029	AC Adapter - Electrical Plug Type B (one per faucet)			\$25.00	
	A14-030	Battery Pack (includes 4x D-cell batteries)			\$51.00	
	None	No Power Supply Provided - must purchase A14-031 separately			N/C	
6-SOAP-MFT Multi-Feed Soap Tank Assembly	Multi-Feed Soap Tank Assembly w/ Battery Pack & Batteries					
	A14-028-PC	Multi-Feed Soap Tank System, w/Battery Pack & Batteries, Cap, Ring, Polished Chrome			\$432.00	
	A14-028-BB	Multi-Feed Soap Tank System, w/Battery Pack & Batteries, Cap, Ring, Brushed Black Stainless			\$461.00	
	A14-028-BS	Multi-Feed Soap Tank System, w/Battery Pack & Batteries, Cap, Ring, Brushed Stainless			\$461.00	
	A14-028-BZ	Multi-Feed Soap Tank System, w/Battery Pack & Batteries, Cap, Ring, Brushed Bronze			\$461.00	
	A14-028-BR	Multi-Feed Soap Tank System, w/Battery Pack & Batteries, Cap, Ring, Brushed Brass			\$461.00	
	A14-028-BN	Multi-Feed Soap Tank System, w/Battery Pack & Batteries, Cap, Ring, Brushed Nickel			\$461.00	
	Multi-Feed Soap Tank Assembly w/ A/C Adapter					
	A14-032-PC	Multi-Feed Soap Tank System, w/A/C Adaptor, Cap, Ring, Polished Chrome			\$508.00	
	A14-032-BB	Multi-Feed Soap Tank System, w/A/C Adaptor, Cap, Ring, Brushed Black Stainless			\$545.00	
	A14-032-BS	Multi-Feed Soap Tank System, w/A/C Adaptor, Cap, Ring, Brushed Stainless			\$545.00	
	A14-032-BZ	Multi-Feed Soap Tank System, w/A/C Adaptor, Cap, Ring, Brushed Bronze			\$545.00	
	A14-032-BR	Multi-Feed Soap Tank System, w/A/C Adaptor, Cap, Ring, Brushed Brass			\$545.00	
	A14-032-BN	Multi-Feed Soap Tank System, w/A/C Adaptor, Cap, Ring, Brushed Nickel			\$545.00	
	Multi-Feed Soap Tank Assembly - [Must Order A14-031 as Separate Line Item with This Selection]					
	A14-033-PC	Multi-Feed Soap Tank System, Cap, Ring, Polished Chrome			\$476.00	
	A14-033-BB	Multi-Feed Soap Tank System, Cap, Ring, Brushed Black Stainless			\$514.00	
	A14-033-BS	Multi-Feed Soap Tank System, Cap, Ring, Brushed Stainless			\$514.00	
	A14-033-BZ	Multi-Feed Soap Tank System, Cap, Ring, Brushed Bronze			\$514.00	
	A14-033-BR	Multi-Feed Soap Tank System, Cap, Ring, Brushed Brass			\$514.00	
A14-033-BN	Multi-Feed Soap Tank System, Cap, Ring, Brushed Nickel			\$514.00		
OPTIONAL SELECTION	A14-031	AC Adapter Splitter Assembly accommodates up to 4 devices when desiring a combination of multiple devices *faucet, soap, & multi-feed soap tank assembly) and/or stations. (Electrical Plug Type B)			\$166.00	



Washroom Accessories Division

TEL: 1-800-BRADLEY FAX: 262-251-5817

Web Site: www.bradleycorp.com

Effective Date March 31, 2023

Series 600 - Soap Dispensers

	Model No.	Description	Shipping Data		Price Each \$	
			Cu. Ft.	Wt. Lbs.		
LAV-MTD. LIQUID SOAP DISPENSER	6315	Sensored, 5-1/2" Spout	0.18	1.59	\$ 184.00	BX
	6315-KT0000	Starter Kit, includes 6315, (4) "D" Cell batteries, and (1) btl. soap	0.37	6.00	\$ 227.00	BX
	6322	Poly Globe, 2 1/2" Spout	0.10	1.10	\$ 51.00	
	6322-68	Poly Globe, 2 1/2" Spout - 32 oz. Polyethylene Globe	0.06	0.84	\$ 55.00	
	6324	Poly Globe, 4" Spout	0.12	1.05	\$ 51.00	BX
	6324-68	Poly Globe, 4" Spout - 32 oz. Polyethylene Globe	0.08	1.20	\$ 51.00	BX
	6326	Poly Globe, 6" Spout	0.10	1.14	\$ 58.00	BX
	6326-68	Poly Globe, 6" Spout - 32 oz. Polyethylene Globe	0.06	0.87	\$ 58.00	BX
	6334	Poly Globe, 3 1/2" Spout - 16 oz. Polyethylene Bottle "Frequency"	0.10	1.20	\$ 147.00	BX
	LIQUID SOAP DISPENSER	643	Recessed, Horizontal	0.44	3.00	\$ 165.00
6437		Recessed, Contemporary Series	0.44	3.51	\$ 170.00	BX
644		Recessed, Vertical	0.44	3.32	\$ 186.00	
646		Recessed, Vertical	0.76	3.32	\$ 269.00	
648		Plastic Globe, Swivel, Push-up Soap Valve, Surface-Mtd.	0.07	0.99	\$ 18.00	
6481		Plastic Globe, Fixed, Push-up Soap Valve, Surface-Mtd.	0.06	0.40	\$ 8.00	
650		Plastic Globe, Push-up Soap Valve, 34 Fl. ounces	0.14	0.70	\$ 23.00	
6501		Plastic Globe, Push-up Soap Valve, 24 Fl. ounces	0.09	1.00	\$ 21.00	BX
6531		Surface-Mtd.	0.24	2.17	\$ 66.00	
6542		Surface-Mtd., Tank Type - Horizontal (24 per master carton)	0.15	2.00	\$ 49.00	BX
6543		Surface-Mtds., Tank Type - Horizontal, ABS Plastic Soap Valve	0.12	1.50	\$ 48.00	
655		Vertical Valve - Surface-Mtd.	0.16	1.79	\$ 95.00	
6562		Surface-Mtd., Tank Type - Vertical (24 per master carton)	0.07	1.55	\$ 52.00	BX
6563		Surface-Mtd., Tank Type - Vertical	0.15	1.71	\$ 55.00	BX
657		Surface-Mtd., Urn Type	0.07	1.21	\$ 38.00	
661		Surface-Mtd., 1 Valve, Shelf Type	0.17	4.64	\$ 140.00	
662		Surface-Mtd., 2 Valves, Shelf Type	0.24	5.08	\$ 160.00	
6843	Surface-Mtd., Foot Operated	0.23	1.91	\$ 54.00	BX	
POWDERED SOAP DISPENSER	658-30	Surface-Mtd., Satin Stainless Steel	0.09	1.35	\$ 43.00	
	6583	Surface-Mtd., Satin Stainless Steel	0.11	1.78	\$ 62.00	
MANUFAL FOAM SOAP DISPENSER	6437-73	Recessed, Contemporary Series	0.50	3.36	\$ 186.00	BX
	6542-73	Surface-Mtd., Tank Type - Horizontal	0.15	2.00	\$ 66.00	BX
	6562-73	Surface-Mtd., Tank Type - Vertical	0.07	2.00	\$ 77.00	BX
	661-73	Surface-Mtd., 1 Valve, Shelf Type	0.18	5.3	\$ 152.00	
	662-73	Surface-Mtd., 2 Valves, Shelf Type	0.24	5.5	\$ 191.00	



Prices subject to change without notice.
Items may be changed or discontinued without notice and without incurring obligation.



Washroom Accessories Division

TEL: 1-800-BRADLEY FAX: 262-251-5817
 Web Site: www.bradleycorp.com

Effective Date March 31, 2023

Series 780 & 781 - Stainless Steel Mirrors

	BX	780	BX	781
16 x 20		\$ 128.00		\$ 102.00
16 x 24		\$ 122.00		\$ 92.00
16 x 30		\$ 148.00		\$ 128.00
18 x 24		\$ 133.00	BX	\$ 72.00
18 x 30	BX	\$ 151.00	BX	\$ 82.00
18 x 32		\$ 255.00		\$ 177.00
18 x 36	BX	\$ 171.00	BX	\$ 90.00
18 x 60		\$ 275.00		\$ 211.00
20 x 36		\$ 298.00		\$ 217.00
20 x 60		\$ 300.00		\$ 254.00
24 x 30		\$ 184.00	BX	\$ 116.00
24 x 36	BX	\$ 181.00	BX	\$ 111.00
24 x 42		\$ 290.00		\$ 284.00
24 x 48		\$ 304.00	BX	\$ 198.00
24 x 60	BX	\$ 319.00	BX	\$ 210.00
* 24 x 72		\$ 472.00		\$ 461.00
30 x 36		\$ 274.00		\$ 216.00
36 x 36		\$ 303.00	BX	\$ 334.00
36 x 48		\$ 582.00		\$ 356.00
* 36 x 72		\$ 886.00		\$ 674.00
48 x 30		\$ 363.00		\$ 293.00
48 x 36		\$ 391.00		\$ 350.00
60 x 24		\$ 398.00		\$ 335.00
* 60 x 36		\$ 512.00		\$ 441.00
72 x 36		\$ 689.00		\$ 594.00



Skid Qty. 15

780- Angle Frame Mirror
 781- Channel Frame Mirror

Mirror Options

Suffix	Description
-2	1/4" Tempered Plate Glass (max. size = 96x60)
-3	Laminate Glass (max. size = 84x48)
-4	Polished Stainless Steel (SS) in Lieu of Glass, # 8 Architectural Grade Finish on 304 Series SS (max. size = 120x47)
-5	Bright Annealed SS in Lieu of Glass (max. size = 120x47)
-6	Plexiglass (max. size = 96x60)

For pricing on special sizes and options not listed on this page please use the configurator in Q20 or contact your local Sales Representative or Customer Service. Special sizes are available in 1" increments.

* = Must be configured in Bradley Q20

Tempered Glass Option -2				
18 x 30		\$ 188.00		\$ 168.00
18 x 36	BX	\$ 242.00	BX	\$ 150.00
24 x 36	BX	\$ 285.00	BX	\$ 210.00
24 x 60		\$ 413.00		\$ -
20 x 60				\$ 355.00

Notes

- Bradley mirrors are overall sizes. Ex. Model 780-1824 measures overall 18"w x 24"h. **Always specify width first.** Height must be between 12" and 72".
- Bradley mirrors are not field interchangeable from horizontal to vertical or vice versa. Ex. Model 780-1824 will mount only 18"w x 24"h, not 24"w x 18"h.
- SHIPPING WEIGHT - To determine approximate shipping weight use a multiplier of 6.25 lbs. Per square foot. Formula: W" x H" divided by 144 x 6.25 = weight.
- Mirrors over 30"w include two (2) hangers.
- MIRROR WEIGHT - Mirror with one hanger max weight 75 lbs. Mirror with two (2) hangers max weight 200 lbs. To find raw mirror weight, use calculation of W" x H" divided by 144 x 5 = weight.
- Mirrors available in 1" increments only

Due to special packaging requirements, all parcel-sized shipments of mirrors will be subject to a \$5.00 per mirror surcharge. The fee for insurance on parcel-sized shipments will be included in the amount added for delivery.

Tempered, Laminated, Plexiglass, and Stainless Steel provide extra security from broken glass and, as a result, may differ in color and reflectivity from standard mirrors. These mirrors will not be accepted for return because of distortion.



Washroom Accessories Division

TEL: 1-800-BRADLEY FAX: 262-251-5817
 Web Site: www.bradleycorp.com

Effective Date March 31, 2023

Series 7805 & 7815 - Stainless Steel Mirrors With Shelf

	BX	7805	BX	7815
16 x 24		\$ 188.00		\$ 202.00
18 x 24		\$ 191.00		\$ 191.00
18 x 30		\$ 209.00		\$ 209.00
18 x 36	BX	\$ 304.00		\$ 224.00
24 x 30		\$ 263.00		\$ 254.00
24 x 36	BX	\$ 334.00	BX	\$ 251.00
* 48 x 36		\$ 621.00		\$ 554.00



For pricing on special sizes and options not listed on this page please contact your local Sales Representative or Customer Service.

* = Must be configured in Bradley Q20

7805- Angle Frame
 7815- Channel Frame

Mirror Options

Suffix	Description
-2	1/4" Tempered Plate Glass (max. size = 96x60)
-3	Laminate Glass (max. size = 84x48)
-4	Polished Stainless Steel (SS) in Lieu of Glass, # 8 Architectural Grade Finish on 304 Series SS (max. size = 120x47-1/2)
-5	Bright Annealed SS in Lieu of Glass (max. size = 120x47-1/2)
-6	Plexiglass (max. size = 96x60)

Notes

- Bradley mirrors are overall sizes. Ex. Model 7815-1824 measures overall 18"w x 24"h. **Always specify width first.** (Max width is 96").
- Bradley mirrors are not field interchangeable from horizontal to vertical or vice versa. Ex. Model 7805-1824 will mount only 18"w x 24"h, not 24"w x 18"h.
- SHIPPING WEIGHT - To determine approximate shipping weight use a multiplier of 6.25 lbs. Per square foot. Formula: W" x H" divided by 144 x 6.25 = weight.
- Mirrors over 30"w have two (2) hangers.
- Mirrors available in 1" increments only

Due to special packaging requirements, all parcel-sized shipments of mirrors will be subject to a \$5.00 per mirror surcharge. The fee for insurance on parcel-sized shipments will be included in the amount added for delivery.

Tempered, Laminated, Plexiglass, and Stainless Steel provide extra security from broken glass but may differ in color and reflectivity from standard mirrors. These mirrors will not be accepted for return because of distortion.





Washroom Accessories Division

TEL: 1-800-BRADLEY FAX: 262-251-5817

Web Site: www.bradleycorp.com

Effective Date March 31, 2023

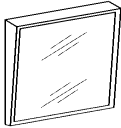
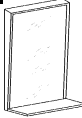
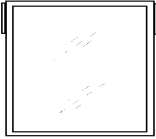
Series 700 - Specialty Poly Glaze® Mirror Units

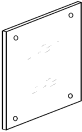
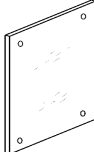
	Model No.	Description	Price Each (\$)	
740 FIXED TILT STAINLESS STEEL FRAMED MIRRORS 	740-1624	16 inches wide by 24 inches high	\$ 222.00	
	740-1630	16 inches wide by 30 inches high	\$ 255.00	
	740-1824	18 inches wide by 24 inches high	\$ 233.00	
	740-1830	18 inches wide by 30 inches high	\$ 285.00	BX
	740-1836	18 inches wide by 36 inches high	\$ 364.00	BX
	740-2430	24 inches wide by 30 inches high	\$ 319.00	
	740-2436	24 inches wide by 36 inches high	\$ 391.00	BX
7405 FIXED TILT MIRROR WITH SHELF 	7405-1830	18 inches wide by 30 inches high	\$ 361.00	
	7405-1836	18 inches wide by 36 inches high	\$ 384.00	
	7405-2430	24 inches wide by 30 inches high	\$ 396.00	
	7405-2436	24 inches wide by 36 inches high	\$ 441.00	
782 ADJUSTABLE TILT STAINLESS STEEL FRAMED MIRROR 	782-1624	16 inches wide by 24 inches high	\$ 160.00	
	782-1630	16 inches wide by 30 inches high	\$ 186.00	
	782-1824	18 inches wide by 24 inches high	\$ 187.00	
	782-1830	18 inches wide by 30 inches high	\$ 188.00	
	782-1836	18 inches wide by 36 inches high	\$ 217.00	
	782-2436	24 inches wide by 36 inches high	\$ 244.00	
747 FRAMELESS MIRROR	747-2436	24 inches wide by 36 inches high	\$ 177.00	BX
	747-3036	30 inches wide by 36 inches high	\$ 209.00	BX
		Maximum Size: 48" x 72" or 72" x 48"		
747F FROSTED FRAMELESS MIRROR 	747F-018300S	18 inches wide by 30 inches high-Solid Border	\$ 255.00	
	747F-018360S	18 inches wide by 36 inches high-Solid Border	\$ 313.00	
	747F-024360S	24 inches wide by 36 inches high-Solid Border	\$ 384.00	
	747F-018300P	18 inches wide by 30 inches high-Plaid Border	\$ 255.00	
	747F-018360P	18 inches wide by 36 inches high-Plaid Border	\$ 313.00	
	747F-024360P	24 inches wide by 36 inches high-Plaid Border	\$ 384.00	
748 FRAMELESS STAINLESS STEEL MIRROR #8 ARCHIT. GRADE FINISH 304 STAINLESS STEEL 	748-1624	16 inches wide by 24 inches high	\$ 177.00	
	748-1824	18 inches wide by 24 inches high	\$ 193.00	
	748-1836	18 inches wide by 36 inches high	\$ 271.00	
	748-2436	24 inches wide by 36 inches high	\$ 334.00	
		Maximum Size: 72" x 47" or 47" x 72"		
7481 FRAMELESS STAINLESS STEEL MIRROR TYPE 430 BRIGHT ANNEALED 	7481-1624	16 inches wide by 24 inches high	\$ 155.00	
	7481-1824	18 inches wide by 24 inches high	\$ 161.00	
	7481-1830	18 inches wide by 30 inches high	\$ 181.00	
	7481-1836	18 inches wide by 36 inches high	\$ 200.00	
	7481-2436	24 inches wide by 36 inches high	\$ 240.00	
			Maximum Size: 72" x 47" or 47" x 72"	

* Mirrors available in 1" increments only

Prices subject to change without notice.
 Items may be changed or discontinued without notice
 and without incurring obligation.



Washroom Accessories Division

TEL: 1-800-BRADLEY FAX: 262-251-5817

Web Site: www.bradleycorp.com

Effective Date March 31, 2023

Series 700 - Stainless Steel Shelves

	Model No.	Description	Shipping Data		Price Each \$	
			Cu. Ft.	Wt. Lbs.		
755 STAINLESS STEEL SHELF - 5" DEPTH	755-12	5" Depth x 12" Length	0.5	1.99	\$ 57.00	BX
	755-16	5" Depth x 16" Length	0.5	3.00	\$ 63.00	
	755-18	5" Depth x 18" Length	0.5	3.46	\$ 66.00	BX
	755-24	5" Depth x 24" Length	0.5	2.95	\$ 71.00	
756 STAINLESS STEEL SHELF - 6" DEPTH	756-18	6" Depth x 18" Length	0.5	2.63	\$ 90.00	
	756-24	6" Depth x 24" Length	0.5	3.34	\$ 109.00	
758 STAINLESS STEEL SHELF - 8" DEPTH	758-16	8" Depth x 16" Length	0.5	3.14	\$ 99.00	
	758-24	8" Depth x 24" Length	0.5	4.00	\$ 116.00	BX
7510 STAINLESS STEEL SHELF - 10" DEPTH		12" to 112" Lengths Available			Custom	
7512 STAINLESS STEEL SHELF - 12" DEPTH		12" to 112" Lengths Available			Custom	
760 RECESSED SHELF, STAINLESS STEEL	760	Recessed Shelf, Stainless Steel	0.7	5.00	\$ 172.00	
790 PULL-DOWN UTILITY SHELF	790	Pull Down Utility Shelf, Heavy Duty Zamac Construction	0.06	4.00	\$ 133.00	
	790-SS	Pull Down Utility Shelf, Stainless Steel Satin Finish	0.06	4.00	\$ 151.00	



Prices subject to change without notice.
 Items may be changed or discontinued without notice
 and without incurring obligation.



Washroom Accessories Division

TEL: 1-800-BRADLEY FAX: 262-251-5817

Web Site: www.bradleycorp.com

Effective Date March 31, 2023

HOW TO SPECIFY GRAB BARS

1. Select Series Number (812, 817, 832, etc.)

HEAVY-DUTY SERIES			
Mounting	1 1/2" diameter	1 1/4" diameter	1" diameter
Concealed	812	832	852
Exposed	817	837	857

2. Select Finish Option (standard, sanitray safety grip, etc.)

FEATURE	ADD SUFFIX
Standard	0
Safety Grip Finish	2
Bright Polished Finish	4
Safety Grip with Polished Finish	7

3. Select Grab Bar Configuration (001, 002, 005, etc.)

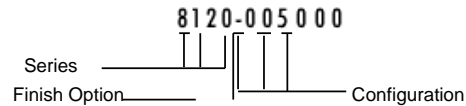

4. Select Dimensions Required

- If no modifications are required to the dimensions, an example of the Part No. is:

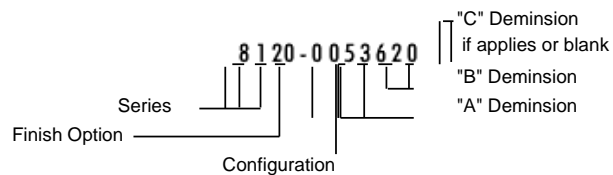

HOW TO MEASURE A GRAB BAR

All Grab Bar Configurations are specified using centerline to centerline dimensions

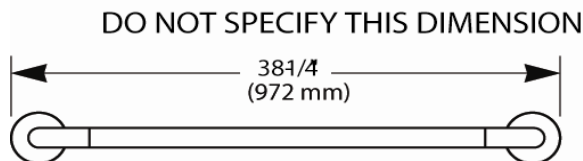
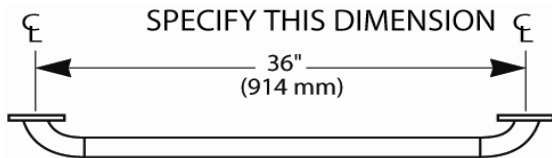

If wall dimensions are given:

- To obtain length of side bars, take clearance (11/2") plus 1/2 of diameter of Grab Bar Series plus an additional 2" and subtract from side wall dimension
- To obtain back bar dimension, take clearance (1 1/2") plus 1/2 of diameter of Grab Bar Series and subtract twice from back wall dimension

Example: 812 Series. If wall dimensions are 30" x 58" x 30", bar dimensions would be 25 3/4" x 53 1/2" x 25 3/4".

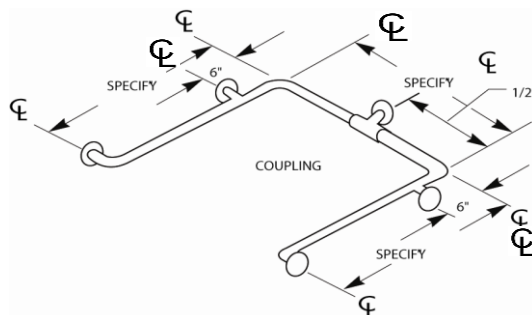

***Please visit the Washroom Accessories Service Parts price book for information and pricing on grab bar mounting kits



Washroom Accessories Division

TEL: 1-800-BRADLEY FAX: 262-251-5817

Web Site: www.bradleycorp.com

Effective Date March 31, 2023

GRAB BAR CONFIGURATIONS - 800 SERIES

001

If the grab bar is greater than 54" order Configuration 002 to receive the required center support

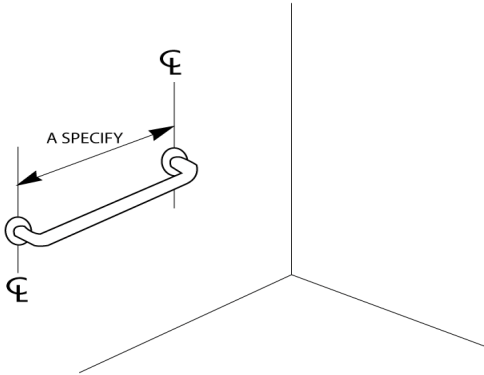

002

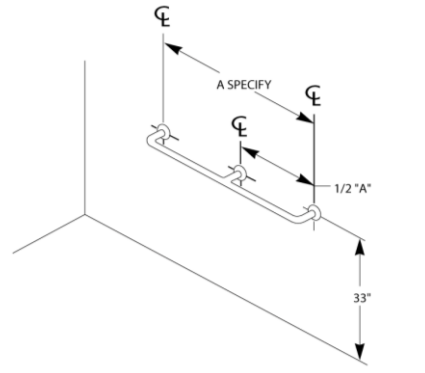

003

Standard length 48", 52", or 54" with center post; only one end return.

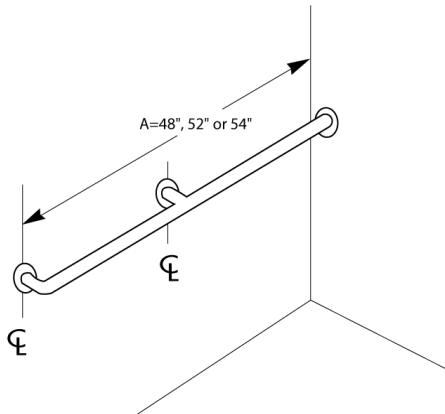

005

"A" dimension will always have stand off.

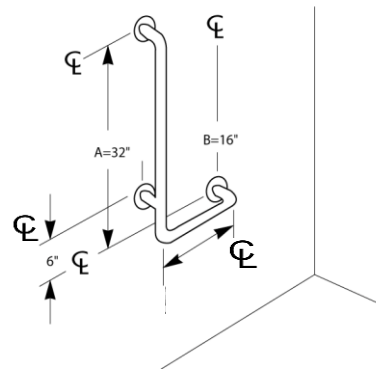

Opposite 005. "A" dimension will always have stand off.

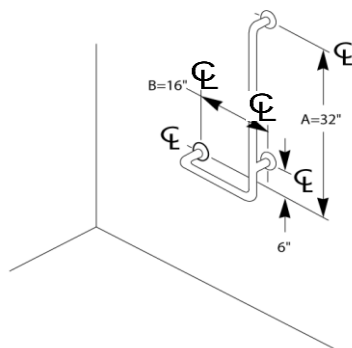

010

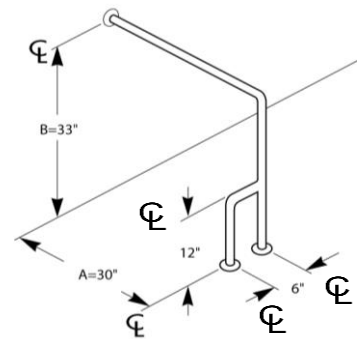



Washroom Accessories Division

TEL: 1-800-BRADLEY FAX: 262-251-5817

Web Site: www.bradleycorp.com

Effective Date March 31, 2023

GRAB BAR CONFIGURATIONS - 800 SERIES (CONTINUED)

011

Opposite 010

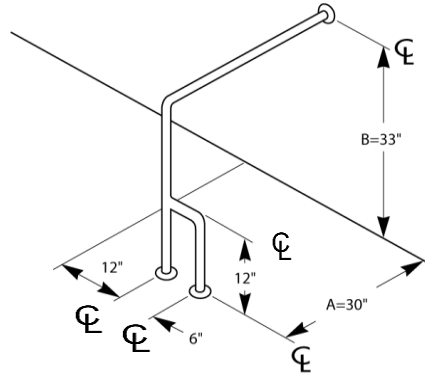

012

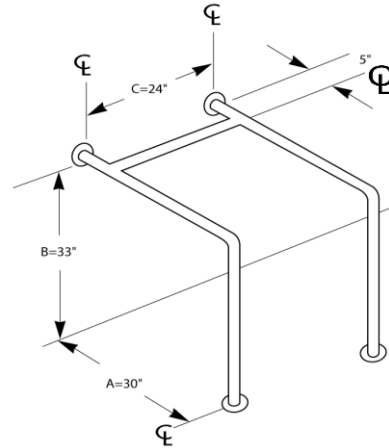

036

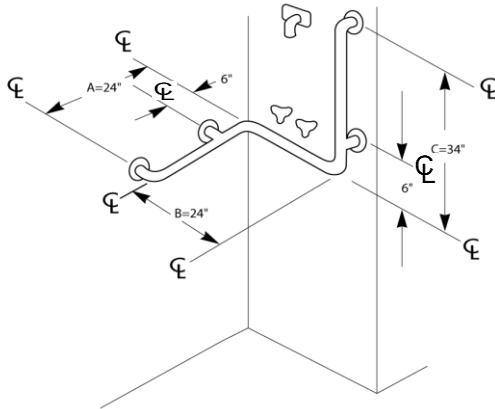

037

Opposite 036

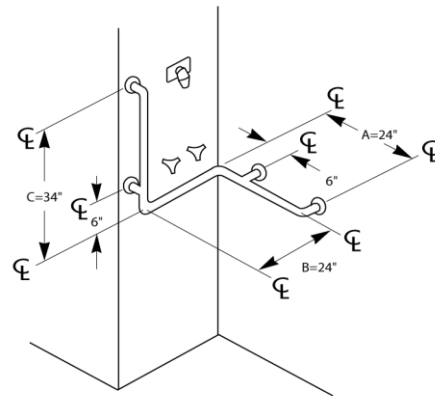

054

30"x33"

Note: 1" tube thickness not available for this application

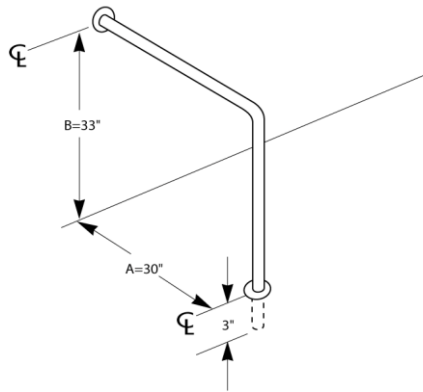

059 - RH

Opposite 058 LH

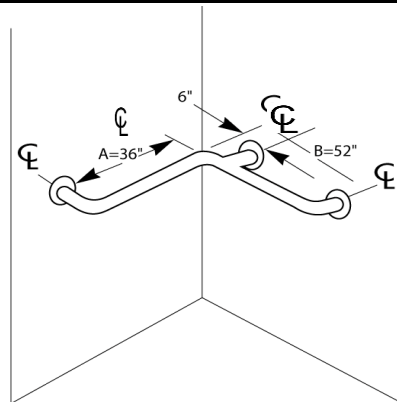



Washroom Accessories Division

TEL: 1-800-BRADLEY FAX: 262-251-5817

Web Site: www.bradleycorp.com

Effective Date March 31, 2023

GRAB BAR CONFIGURATIONS - 800 SERIES (CONTINUED)

060

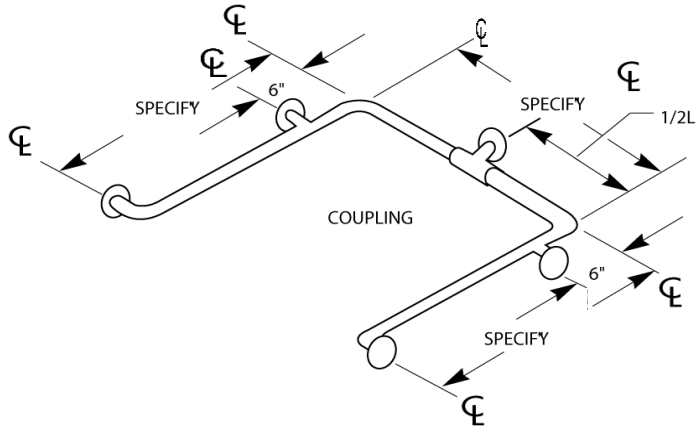

For a complete list of railings, mounting kits, and anchoring devices, please see our technical data catalog.



Washroom Accessories Division

TEL: 1-800-BRADLEY FAX: 262-251-5817
 Web Site: www.bradleycorp.com

Effective Date March 31, 2023

SERIES 812 GRAB BARS - 1-1/2" O.D.

Bradley Grab Bars are made of type-304, 18-gauge stainless steel. The exposed surfaces of the seamless constructed Grab Bar are available in an architectural satin (8120 Series), safety grip (8122 Series), bright polished (8124 Series), or safety grip with bright polished (8127 Series) finish. Mounting flanges for the Grab Bars are concealed by snap-on escutcheons.

Config. No.	Description	Shipping Data		(BX)	8120 Series	(BX)	8122 Series	(BX)	8124 Series	(BX)	8127 Series
		Cu. Ft.	Wt. Lbs		Price \$		Price \$		Price \$		Price \$
001120	Grab Bar 1-1/2" OD X 12	0.13	1.22	BX	\$ 47.00	BX	\$ 55.00		Custom		Custom
001160	Grab Bar 1-1/2" OD X 16	0.14	1.46		\$ 47.00		Custom		Custom		Custom
001180	Grab Bar 1-1/2" OD X 18	0.14	1.54	BX	\$ 47.00	BX	\$ 56.00		Custom		Custom
001180AM	Grab Bar 1-1/2" OD X 18, AM	0.14	1.54		\$ 76.00		n/a		n/a		n/a
001240	Grab Bar 1-1/2" OD X 24	0.14	1.99	BX	\$ 50.00	BX	\$ 57.00		Custom		Custom
001240AM	Grab Bar 1-1/2" OD X 24, AM	0.14	1.99		\$ 77.00		n/a		n/a		n/a
001300	Grab Bar 1-1/2" OD X 30	0.15	2.30	BX	\$ 55.00		\$ 68.00		Custom		Custom
001320	Grab Bar 1-1/2" OD X 32	0.15	2.43		\$ 57.00		\$ 68.00		Custom		Custom
001360	Grab Bar 1-1/2" OD X 36	0.15	3.00	BX	\$ 57.00	BX	\$ 68.00		Custom		\$ 129.00
001360AM	Grab Bar 1-1/2" OD X 36, AM	0.15	3.00		\$ 78.00		n/a		n/a		n/a
001400	Grab Bar 1-1/2" OD X 40	0.15	2.94		\$ 60.00		Custom		Custom		Custom
001420	Grab Bar 1-1/2" OD X 42	0.15	3.36	BX	\$ 60.00	BX	\$ 71.00		Custom		\$ 156.00
001420AM	Grab Bar 1-1/2" OD X 42, AM	0.15	3.36		\$ 79.00		n/a		n/a		n/a
001480	Grab Bar 1-1/2" OD X 48	0.25	3.40	BX	\$ 68.00	BX	\$ 76.00		Custom		Custom
001520	Grab Bar 1-1/2" OD X 52	0.25	3.63		\$ 100.00		Custom		Custom		Custom
001540	Grab Bar 1-1/2" OD X 54	0.25	4.03		\$ 103.00		Custom		Custom		Custom
002360	Grab Bar 1-1/2" OD X 36	0.25	2.89		\$ 105.00		Custom		Custom		Custom
002420	Grab Bar 1-1/2" OD X 42	0.25	3.48		\$ 112.00		Custom		Custom		Custom
002480	Grab Bar 1-1/2" OD X 48	0.25	3.78		\$ 123.00		\$ 153.00		Custom		Custom
002540	Grab Bar 1-1/2" OD X 54	0.29	4.04		\$ 160.00		Custom		Custom		Custom
003480	Grab Bar 1-1/2" OD X 48	0.25	3.18		\$ 124.00		Custom		Custom		Custom
003520	Grab Bar 1-1/2" OD X 52	0.29	3.93		\$ 128.00		\$ 169.00		Custom		Custom
003540	Grab Bar 1-1/2" OD X 54	0.29	4.04		\$ 130.00		Custom		Custom		Custom
004000	Grab Bar 1-1/2"OD X 12 X 12	0.62	3.00		\$ 108.00		\$ 153.00		\$ 169.00		\$ 162.00
005000	Grab Bar 1-1/2" OD X 32 X 16	1.10	3.68		\$ 140.00		\$ 181.00		\$ 210.00		\$ 244.00
006000	Grab Bar 1-1/2" OD X 32 X 16	1.10	3.74		\$ 140.00		\$ 181.00		\$ 210.00		\$ 244.00
007000	Grab Bar 1-1/2" OD X 34X25X34	2.30	9.00		\$ 233.00		\$ 300.00		Custom		Custom
010000	Grab Bar 1-1/2" OD X 30 X 33	1.10	5.30		\$ 208.00		\$ 265.00		Custom		\$ 436.00
011000	Grab Bar 1-1/2" OD X 30 X 33	1.10	5.37		\$ 208.00		\$ 264.00		\$ 336.00		\$ 436.00
012000	Grab Bar 1-1/2"ODX30X33X24	6.30	11.00		\$ 342.00		\$ 371.00		Custom		\$ 603.00
022000	Grab Bar 1-1/2"OD X 40 X 32	1.55	7.00		\$ 222.00		Custom		Custom		Custom
023000	Grab Bar 1-1/2"OD X 40 X 32	1.55	7.00		\$ 222.00		Custom		Custom		Custom
024000	Grab Bar 1-1/2"OD X 40, Tub	1.20	7.00		\$ 322.00		\$ 373.00		Custom		Custom

Notes:

Custom: These are Custom order Grab Bars. Please contact customer service for a quotation. Custom Grab Bars are available in 1" increments.

For information on other available sizes, options, and prices not listed on this page please contact your local Sales Representative or Customer Service.

Prices subject to change without notice.
 Items may be changed or discontinued without notice
 and without incurring obligation.



Washroom Accessories Division

TEL: 1-800-BRADLEY FAX: 262-251-5817

Web Site: www.bradleycorp.com

Effective Date March 31, 2023

SERIES 812 GRAB BARS - 1-1/2" O.D. (CONTINUED)

Bradley Grab Bars are made of type-304, 18-gauge stainless steel. The exposed surfaces of the seamless constructed Grab Bar are available in an architectural satin (8120 Series), safety grip (8122 Series), bright polished (8124 Series), or safety grip with bright polished (8127 Series) finish. Mounting flanges for the Grab Bars are concealed by snap-on escutcheons.

Config. No.	Description	Shipping Data		(BX)	8120 Series	(BX)	8122 Series	(BX)	8124 Series	(BX)	8127 Series
		Cu. Ft.	Wt. Lbs		Price \$		Price \$		Price \$		Price \$
026000	Grab Bar 1-1/2"OD X 40, Tub	0.90	5.00		\$ 218.00		Custom		Custom		Custom
027000	Grab Bar 1-1/2"OD X 40, Tub	0.90	5.00		\$ 218.00		\$ 270.00		Custom		Custom
030000	Grab Bar 1-1/2"ODX36X20X24	6.10	8.00		\$ 242.00		\$ 279.00		Custom		Custom
031000	Grab Bar 1-1/2"ODX36X20X24	6.10	8.00		\$ 242.00		\$ 280.00		Custom		Custom
032000	Grab Bar 1-1/2"OD X 24 X 34	1.45	6.00		\$ 173.00		\$ 203.00		\$ 310.00		\$ 309.00
033000	Grab Bar 1-1/2"OD X 24 X 34	1.45	6.00		\$ 173.00		\$ 203.00		Custom		Custom
034000	Grab Bar 1-1/2"ODX26X26X24	5.85	7.00		\$ 279.00		\$ 343.00		Custom		\$ 501.00
035000	Grab Bar 1-1/2"ODX26X26X24	5.85	7.00		\$ 279.00		\$ 356.00		Custom		\$ 501.00
036000	Grab Bar 1-1/2"ODX24X24X34	5.85	8.00		\$ 233.00		\$ 280.00		Custom		Custom
037000	Grab Bar 1-1/2"ODX24X24X34	5.85	5.88		\$ 233.00		\$ 280.00		Custom		Custom
039000	Grab Bar 1-1/2"ODX28X22X22	8.70	11.10		\$ 272.00		\$ 332.00		Custom		Custom
039100	Grab Bar 1-1/2"ODX28X22X22	1.00	10.00		\$ 207.00		\$ 257.00		Custom		Custom
040000	Grab Bar 1-1/2"OD X 32 X 9	0.95	5.00		\$ 108.00		\$ 162.00		Custom		Custom
041000	Grab Bar 1-1/2"OD X 32 X 9	0.95	5.00		\$ 108.00		\$ 130.00		Custom		Custom
048160	Grab Bar 1-1/2" OD X 16, RH	0.14	1.46		\$ 68.00		Custom		Custom		Custom
048240	Grab Bar 1-1/2" OD X 24, RH	0.14	1.99		\$ 76.00		\$ 94.00		Custom		Custom
048280	Grab Bar 1-1/2" OD X 28, RH	0.18	2.27		\$ 78.00		Custom		Custom		Custom
048360	Grab Bar 1-1/2" OD X 36, RH	0.15	3.00		\$ 103.00		Custom		Custom		Custom
048420	Grab Bar 1-1/2" OD X 42, RH	0.15	3.36		\$ 108.00		\$ 111.00		Custom		Custom
048540	Grab Bar 1-1/2" OD X 54, RH	0.25	4.03		\$ 114.00		Custom		Custom		Custom
049180	Grab Bar 1-1/2" OD X 18, LH	0.14	1.54		\$ 78.00		Custom		Custom		Custom
049320	Grab Bar 1-1/2" OD X 32, LH	0.15	2.43		\$ 100.00		Custom		Custom		Custom
054000	Grab Bar 1-1/2" OD, 30 X 33	1.10	4.40		\$ 114.00		\$ 148.00		\$ 203.00		\$ 226.00
055000	Grab Bar 1-1/2" OD, 24 X 24	1.40	3.30		\$ 124.00		\$ 148.00		Custom		Custom
056000	Grab Bar 1-1/2" OD, 18X33X27	1.28	9.00		\$ 235.00		\$ 432.00		Custom		Custom
0584052	Grab Bar 1-1/2" OD X40X52 LH	4.63	6.54		\$ 193.00		Custom		Custom		Custom
0581530	Grab Bar 1-1/2" OD X15X30 LH	1.19	3.38		\$ 160.00		\$ 193.00		Custom		Custom
0581830	Grab Bar 1-1/2" OD X18X30 LH	1.97	3.74		\$ 162.00		\$ 202.00		Custom		Custom

Notes:

Custom: These are Custom order Grab Bars. Please contact customer service for a quotation. Custom Grab Bars are available in 1" increments.

The 001 style Grab Bar can be ordered in lieu of a corridor railing if the length is less than 54" in length.

For information on other available sizes, options, and prices not listed on this page please contact your local Sales Representative or Customer Service.

Prices subject to change without notice.
Items may be changed or discontinued without notice and without incurring obligation.



Washroom Accessories Division

0 TEL: 1-800-BRADLEY FAX: 262-251-5817
Web Site: www.bradleycorp.com

Effective Date March 31, 2023

SERIES 812 GRAB BARS - 1-1/2" O.D. (CONTINUED)

Bradley Grab Bars are made of type-304, 18-gauge stainless steel. The exposed surfaces of the seamless constructed Grab Bar are available in an architectural satin (8120 Series), safety grip (8122 Series), bright polished (8124 Series), or safety grip with bright polished (8127 Series) finish. Mounting flanges for the Grab Bars are concealed by snap-on escutcheons.

Config. No.	Description	Shipping Data		(BX)	8120 Series	(BX)	8122 Series	(BX)	8124 Series	(BX)	8127 Series
		Cu. Ft.	Wt. Lbs.		Price \$		Price \$		Price \$		Price \$
0581836	Grab Bar 1-1/2" OD X 18 X 36 LH	1.69	3.88		\$174.00		Custom		Custom		Custom
0582436	Grab Bar 1-1/2" OD X 24 X 36 LH	2.04	4.44		\$176.00		Custom		Custom		Custom
0583652	Grab Bar 1-1/2" OD X 36 x 52 LH	4.04	6.29		\$186.00		\$239.00		Custom		Custom
0583654	Grab Bar 1-1/2" OD X 36 X 54 LH	4.34	6.16		\$176.00		\$254.00		Custom		Custom
0584254	Grab Bar 1-1/2" OD X 42 X 54 LH	4.34	6.55		\$193.00		\$264.00		Custom		Custom
059000	Grab Bar 1-1/2" OD X 40 X 52 RH	4.63	6.54	BX	\$203.00		\$253.00		\$311.00		\$377.00
0591530	Grab Bar 1-1/2" OD X 15 X 30 RH	1.19	3.38		\$160.00		\$193.00		Custom		Custom
0591830	Grab Bar 1-1/2" OD X 18 X 30 RH	1.97	3.74		\$162.00		\$202.00		Custom		\$289.00
0591836	Grab Bar 1-1/2" OD X 18 X 36 RH	1.69	3.88		\$174.00		\$207.00		Custom		\$309.00
0592436	Grab Bar 1-1/2" OD X 24 X 36 RH	2.04	4.44		\$176.00		\$210.00		\$273.00		\$324.00
0593652	Grab Bar 1-1/2" OD X 36 x 52 RH	4.04	6.29		\$186.00		\$239.00		Custom		Custom
0593654	Grab Bar 1-1/2" OD X 36 X 54 RH	4.34	6.16		\$176.00		\$254.00		Custom		\$393.00
0594254	Grab Bar 1-1/2" OD X 42 X 54 RH	4.34	6.55		\$193.00		\$264.00		Custom		Custom
060306030	Grab Bar 1-1/2" OD 30 X 60 X30	4.44	9.50		\$433.00		\$560.00		Custom		\$765.00
060366036	Grab Bar 1-1/2" OD 36 X 60 X36	4.44	9.80		\$446.00		\$575.00		Custom		Custom
115000	Grab Bar 1-1/2" OD 16 X 24 X 12	1.20	6.00		\$257.00		\$324.00		Custom		\$496.00
116000	Grab Bar 1-1/2" OD 16 X 24 X 12	1.20	6.00		\$257.00		\$331.00		Custom		Custom
117000	Grab Bar 1-1/2" OD 16 X 24 X 24	1.30	8.87		\$374.00		\$486.00		Custom		\$589.00
118000	Grab Bar 1-1/2" OD 16 X 24 X 24	0.95	11.00		\$392.00		\$506.00		Custom		Custom
119000	Grab Bar 1-1/2" OD 16 X 24 X 28	2.20	7.00		\$257.00		\$331.00		Custom		Custom
120000	Grab Bar 1-1/2" OD 16 X 24 X 28	2.20	7.00		\$264.00		\$331.00		Custom		Custom

Notes:

Custom: These are Custom order Grab Bars. Please contact customer service for a quotation. Custom Grab Bars are available in 1" increments.

The 001 style Grab Bar can be ordered in lieu of a corridor railing if the length is less than 54" in length.

For information on other available sizes, options, and prices not listed on this page please contact your local Sales Representative or Customer Service.



Washroom Accessories Division

TEL: 1-800-BRADLEY FAX: 262-251-5817

Web Site: www.bradleycorp.com

Effective Date March 31, 2023

812 SERIES GRAB BAR MULTI PACKS

The packaging style pictured below is ideal for anyone who needs to warehouse Bradley Grab Bars. This convenient stocking option is available in the sizes below, pre-packaged in quantities of 10 or 20 Grab Bars. All Grab Bars inside the master carton are of the same length and are individually packaged in a plastic bag with a label.

When the product arrives at your location, cut off the end where it states to 'Cut Here', and the grab bars can be easily organized and accessed when needed.

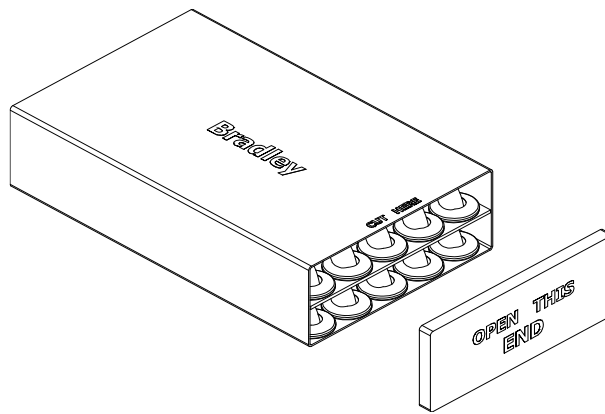

10 Pack Pictured

10-Pack Master Carton		Shipping Data		Price Each \$
Model No.	Cu. Ft.	Wt. Lbs.	(BX)	
8120-001180-10	1.66	18.79		\$ 471.00
8122-001180-10	1.66	18.79		\$ 583.00
8120-001240-10	1.66	22.59		\$ 528.00
8122-001240-10	1.66	22.59		\$ 622.00
8120-001300-10	2.40	25.56		\$ 549.00
8122-001300-10	2.40	25.56		\$ 678.00
8120-001360-10	2.40	30.46	BX	\$ 583.00
8122-001360-10	2.40	30.46		\$ 697.00
8120-001420-10	3.14	37.67	BX	\$ 605.00
8122-001420-10	3.14	37.67		\$ 737.00
8120-001480-10	3.14	40.97		\$ 678.00
8122-001480-10	3.14	40.97		\$ 755.00

20-Pack Master Carton		Shipping Data		Price Each \$
Model No.	Cu. Ft.	Wt. Lbs.		
8120-001180-20	3.36	37.35		\$ 942.00
8122-001180-20	3.36	37.35		\$ 1,171.00
8120-001240-20	3.36	44.95		\$ 1,056.00
8122-001240-20	3.36	44.95		\$ 1,246.00
8120-001300-20	4.85	51.78		\$ 1,091.00
8122-001300-20	4.85	51.78		\$ 1,360.00
8120-001360-20	4.85	61.58		\$ 1,171.00
8122-001360-20	4.85	61.58		\$ 1,395.00
8120-001420-20	6.34	72.92		\$ 1,205.00
8122-001420-20	6.34	72.92		\$ 1,469.00
8120-001480-20	6.34	79.52		\$ 1,360.00
8122-001480-20	6.34	79.52		\$ 1,505.00

Prices subject to change without notice.
Items may be changed or discontinued without notice and without incurring obligation.



Washroom Accessories Division

TEL: 1-800-BRADLEY FAX: 262-251-5817

Web Site: www.bradleycorp.com

Effective Date March 31, 2023

SERIES 817 GRAB BARS - 1-1/2" O.D.

Bradley Grab Bars are made of type-304, 18-gauge stainless steel. The exposed surfaces of the seamless constructed Grab Bar are available in an architectural satin (8170 Series), safety grip (8172), or safety grip with bright polished (8177 Series) finish. The mounting flanges for the 817 grab bars are exposed.

Config. No.	Description	Shipping Data		(BX)	8170 Series	(BX)	8172 Series	(BX)	8177 Series
		Cu. Ft.	Wt. Lbs		Price \$		Price \$		Price \$
001120	Grab Bar 1-1/2" OD X 12	0.13	1.28		\$ 47.00		\$ 61.00		Custom
001180	Grab Bar 1-1/2" OD X 18	0.14	1.58		\$ 56.00		\$ 67.00		Custom
001240	Grab Bar 1-1/2" OD X 24	0.14	1.99		\$ 57.00		\$ 69.00		Custom
001300	Grab Bar 1-1/2" OD X 30	0.15	2.30		\$ 57.00		\$ 76.00		Custom
001320	Grab Bar 1-1/2" OD X 32	0.15	2.43		\$ 58.00		Custom		Custom
001360	Grab Bar 1-1/2" OD X 36	0.15	2.60	BX	\$ 60.00	BX	\$ 76.00		Custom
001420	Grab Bar 1-1/2" OD X 42	0.15	3.07	BX	\$ 61.00	BX	\$ 91.00		Custom
001480	Grab Bar 1-1/2" OD X 48	0.25	3.38		\$ 77.00		\$ 100.00		Custom
002480	Grab Bar 1-1/2" OD X 48	0.25	3.61		\$ 119.00		Custom		Custom
003520	Grab Bar 1-1/2" OD X 52	0.29	5.00		\$ 139.00		Custom		Custom
048420	Grab Bar 1-1/2"OD X 42, RH	0.15	3.07		\$ 104.00		Custom		Custom
054000	Grab Bar 1-1/2" OD X 30 X 33	0.15	4.60		\$ 124.00		\$ 160.00		Custom
158000	Swing-Away Grab Bar 1-1/2 OD	2.75	15.31		\$ 655.00		\$ 792.00		Custom
158100	Swing-Away Grab Bar 1-1/2 OD	2.75	16.15		\$ 818.00		\$ 960.00		Custom

Notes:

Custom: These are Custom order Grab Bars. Please contact customer service for a quotation. Custom Grab Bars are available in 1" increments.

The 001 style Grab Bar can be ordered in lieu of a corridor railing if the length is less than 54" in length.

For information on other available sizes, options, and prices not listed on this page please contact your local Sales Representative or customer service.



Washroom Accessories Division

TEL: 1-800-BRADLEY FAX: 262-251-5817

Web Site: www.bradleycorp.com

Effective Date March 31, 2023

SERIES 832 GRAB BARS - 1-1/4" O.D.

Bradley Grab Bars are made of type-304, 18-gauge stainless steel. The exposed surfaces of the seamless constructed Grab Bar are available in an architectural satin (8320 Series), safety grip (8322 Series), bright polished (8324 Series), or safety grip with bright polished (8327 Series) finish. Mounting flanges for the Grab Bars are concealed by snap-on escutcheons

Config. No.	Description	Shipping Data		(BX)	8320 Series	(BX)	8322 Series	(BX)	8324 Series	(BX)	8327 Series
		Cu. Ft.	Wt. Lbs.		Price \$		Price \$		Price \$		Price \$
001120	Grab Bar 1-1/4"OD X 12	0.13	1.18		\$ 46.00	BX	\$ 56.00		Custom		\$103.00
001180	Grab Bar 1-1/4"OD X 18	0.14	1.46	BX	\$ 46.00	BX	\$ 56.00		Custom		Custom
001240	Grab Bar 1-1/4" OD X 24	0.14	1.79	BX	\$ 47.00	BX	\$ 60.00		Custom		\$110.00
001300	Grab Bar 1-1/4"OD X 30	0.15	2.03	BX	\$ 48.00		\$ 60.00		Custom		Custom
001320	Grab Bar 1-1/4"OD X 32	0.15	2.15		\$ 53.00		Custom		Custom		Custom
001360	Grab Bar 1-1/4" OD X 36	0.15	2.43	BX	\$ 50.00	BX	\$ 61.00		Custom		\$130.00
001420	Grab Bar 1-1/4" OD X 42	0.15	2.81	BX	\$ 55.00	BX	\$ 62.00		Custom		\$140.00
001480	Grab Bar 1-1/4" OD X 48	0.25	3.01	BX	\$ 61.00	BX	\$ 68.00		Custom		\$148.00
002480	Grab Bar 1-1/4"OD X 48	0.25	3.22		\$ 110.00		\$ 148.00		Custom		Custom
004000	Grab Bar 1-1/4"OD X 12 X 12	0.62	3.00		\$ 94.00		\$ 103.00		\$ 140.00		\$140.00
005000	Grab Bar 1-1/4"OD X 32 X 16	1.10	5.00		\$ 126.00		\$ 129.00		Custom		\$218.00
006000	Grab Bar 1-1/4"OD X 32 X 16	1.10	5.00		\$ 126.00		\$ 157.00		\$ 270.00		\$218.00
007000	Grab Bar 1-1/4"OD X 34X25X34,	1.10	5.00		\$ 242.00		\$ 267.00		Custom		Custom
010000	Grab Bar 1-1/4"OD X 30 X 33	1.10	5.00		\$ 203.00		\$ 226.00		Custom		\$345.00
011000	Grab Bar 1-1/4"OD X 30 X 33	1.10	5.00		\$ 203.00		\$ 226.00		Custom		\$345.00
012000	Grab Bar 1-1/4"OD X 30 X 33	6.30	10.00		\$ 339.00		\$ 383.00		Custom		Custom
030000	Grab Bar 1-1/4"OD X 36 X 20 X 24	6.10	7.00		\$ 254.00		\$ 279.00		Custom		\$459.00
031000	Grab Bar 1-1/4"OD X 36 X 20 X 24	6.10	8.00		\$ 254.00		\$ 262.00		Custom		Custom
032000	Grab Bar 1-1/4"ODX24X34 SHWR	1.45	5.00		\$ 164.00		\$ 176.00		Custom		Custom
033000	Grab Bar 1-1/4"ODX24X34 SHWR	1.45	5.00		\$ 164.00		\$ 176.00		\$ 239.00		Custom
036000	Grab Bar 1-1/4"ODX24X24X34	17.42	5.05		\$ 279.00		\$ 263.00		\$ 325.00		Custom
037000	Grab Bar 1-1/4"ODX24X24X34	17.42	5.05		\$ 279.00		\$ 263.00		Custom		Custom
039000	Grab Bar 1-1/4"ODX28X28X22	8.70	15.00		\$ 273.00		\$ 301.00		Custom		Custom
040000	Grab Bar 1-1/4"OD X 32 X 9	0.95	4.00		\$ 104.00		\$ 114.00		\$ 138.00		Custom
041000	Grab Bar 1-1/4"OD X 32 X 9	0.95	4.00		\$ 104.00		\$ 114.00		\$ 138.00		Custom
048240	Grab Bar 1-1/4"OD X 24, RH	0.14	1.79		\$ 88.00		Custom		Custom		Custom

Notes:

Custom: These are Custom order Grab Bars. Please contact customer service for a quotation. Custom Grab Bars are available in 1" increments.

The 001 style Grab Bar can be ordered in lieu of a corridor railing if the length is less than 54" in length.

For information on other available sizes, options, and prices not listed on this page please contact your local Sales Representative or Customer Service.



Washroom Accessories Division

TEL: 1-800-BRADLEY FAX: 262-251-5817

Web Site: www.bradleycorp.com

Effective Date March 31, 2023

SERIES 832 GRAB BARS - 1-1/4" O.D. (CONTINUED)

Bradley Grab Bars are made of type-304, 18-gauge stainless steel. The exposed surfaces of the seamless constructed Grab Bar are available in an architectural satin (8320 Series), safety grip (8322 Series), bright polished (8324 Series), or safety grip with bright polished (8327 Series) finish. Mounting flanges for the Grab Bars are concealed by snap-on escutcheons

Config. No.	Description	Shipping Data		(BX)	8320 Series	(BX)	8322 Series	(BX)	8324 Series	(BX)	8327 Series
		Cu. Ft.	Wt. Lbs		Price \$		Price \$		Price \$		Price \$
048360	Grab Bar 1-1/4"OD X 36, RH,	0.15	2.43		\$ 99.00		Custom		Custom		Custom
049160	Grab Bar 1-1/4"OD X 16, LH,	0.14	1.79		\$ 78.00		Custom		Custom		Custom
049240	Grab Bar 1-1/4"OD X 24, LH,	0.14	1.79		\$108.00		Custom		Custom		\$110.00
054000	Grab Bar 1-1/4"OD X 30 X 33	1.10	3.89		\$110.00		\$130.00		Custom		Custom
055000	Grab Bar 1-1/4"OD X 24 X 24	1.37	3.45		\$123.00	BX	\$100.00		Custom		Custom
057000	Grab Bar 1-1/4"OD X 30 X 30	2.17	2.75		\$133.00		\$192.00		Custom		Custom
0581830	Grab Bar 1-1/4"OD X 18 X 30 LH	2.00	3.20		\$151.00		Custom		Custom		Custom
0582436	Grab Bar 1-1/4"OD X 24 X 36 LH	2.00	4.02		\$164.00		Custom		Custom		Custom
0583654	Grab Bar 1-1/4"OD X 36 X 54 LH	4.26	5.24		\$186.00		Custom		Custom		Custom
0584254	Grab Bar 1-1/4"OD X 42 X 54 LH	4.89	5.93		\$198.00		Custom		Custom		Custom
059000	Grab Bar 1-1/4"OD X 40 X 52 RH	4.59	5.69		\$180.00		\$227.00		Custom		Custom
0591830	Grab Bar 1-1/4"OD X 18 X 30 RH	2.00	3.20		\$151.00		\$190.00		Custom		Custom
0592436	Grab Bar 1-1/4"OD X 24 X 36 RH	2.00	4.02		\$164.00		\$205.00		Custom		Custom
0593652	Grab Bar 1-1/4"OD X 36 X 52 RH	4.07	5.48		\$202.00		\$236.00		Custom		Custom
0593654	Grab Bar 1-1/4"OD X 36 X 54 RH	4.26	5.24		\$186.00		\$236.00		Custom		Custom
0594254	Grab Bar 1-1/4"OD X 42 X 54 RH	4.89	5.93		\$198.00		\$246.00		Custom		Custom
106360	Bariatric Grab Bar 1-1/4" OD 36"	0.21	2.80		\$242.00		\$291.00		NA		NA
106420	Bariatric Grab Bar 1-1/4" OD 42"	0.24	3.10		\$296.00		\$348.00		NA		NA
117000	Grab Bar 1-1/4" OD X 16 X 24	1.30	10.00		\$367.00		\$474.00		Custom		Custom
118000	Grab Bar 1-1/4" OD X 16 X 24	0.95	10.00		\$367.00		\$474.00		Custom		Custom

Notes:

Custom: These are Custom order Grab Bars. Please contact customer service for a quotation. Custom Grab Bars are available in 1" increments.

The 001 style Grab Bar can be ordered in lieu of a corridor railing if the length is less than 54" in length.

For information on other available sizes, options, and prices not listed on this page please contact your local Sales Representative or Customer Service.



Washroom Accessories Division

TEL: 1-800-BRADLEY FAX: 262-251-5817
 Web Site: www.bradleycorp.com

Effective Date March 31, 2023

SERIES 837 GRAB BARS - 1-1/4" O.D.

Bradley Grab Bars are made of type-304, 18-gauge stainless steel. The exposed surfaces of the seamless constructed grab bar are available in an architectural satin (8370 Series), safety grip (8372), bright polished (8374), or safety grip with bright polished (8377 Series) finish. The mounting flanges for the 837 Grab Bars are exposed.

Config. No.	Description	Shipping Data		(BX)	8370 Series	(BX)	8372 Series	(BX)	8374 Series	(BX)	8377 Series
		Cu. Ft.	Wt. Lbs		Price \$		Price \$		Price \$		Price \$
001240	Grab Bar 1-1/4"OD X 24	0.14	1.73		\$ 57.00		\$ 55.00		Custom		Custom
001300	Grab Bar 1-1/4"OD X 30	0.15	2.00		\$ 60.00		Custom		Custom		Custom
001360	Grab Bar 1-1/4"OD X 36	0.15	2.41		\$ 60.00		\$ 73.00		Custom		Custom
001420	Grab Bar 1-1/4"OD X 42	0.15	2.69		\$ 67.00		\$ 79.00		Custom		Custom
001480	Grab Bar 1-1/4"OD X 48	0.25	3.11		\$ 69.00		\$ 94.00		Custom		Custom
048480	Grab Bar 1-1/4"OD X 48, RH	0.25	3.11		\$ 94.00		Custom		Custom		Custom
054000	Grab Bar 1-1/4"ODX30X33	1.10	6.00		\$ 123.00		Custom		Custom		Custom
055000	Grab Bar 1-1/4"ODX24X24	0.64	7.00		Custom		\$ 143.00		Custom		Custom
060306030	Grab Bar 1-1/4"ODX30X60X30	4.44	9.50		\$ 497.00		Custom		Custom		Custom
107000	Swing Up Grab Bar, 1-1/4"OD	1.35	7.80	BX	\$ 495.00	BX	\$ 518.00		NA		NA
108000	Swing Up Grab Bar, 1-1/4"OD	1.35	9.00	BX	\$ 606.00	BX	\$ 639.00		NA		NA

Notes:

Custom: These are Custom order Grab Bars. Please contact customer service for a quotation. Custom Grab Bars are available in 1" increments.

The 001 style Grab Bar can be ordered in lieu of a corridor railing if the length is less than 54" in length.

For information on other available sizes, options, and prices not listed on this page please contact your local Sales Representative or Customer Service.



Washroom Accessories Division

TEL: 1-800-BRADLEY FAX: 262-251-5817
 Web Site: www.bradleycorp.com

Effective Date March 31, 2023

SERIES 852 GRAB BARS - 1" O.D.

Bradley Grab Bars are made of type-304, 22-gauge stainless steel. The exposed surfaces of the seamless constructed Grab Bar are available in an architectural satin (8520 Series), safety grip (8522), bright polished (8524), or safety grip with bright polished (8527 Series) finish.

Config. No.	Description	Shipping Data		(BX)	8520 Series	(BX)	8522 Series	(BX)	8524 Series	(BX)	8527 Series
		Cu. Ft.	Wt. Lbs		Price \$		Price \$		Price \$		Price \$
001180	BX-Grab Bar 1" OD X 18	0.14	1.32	BX	\$ 62.00		Custom		Custom		Custom
001240	BX-Grab Bar 1" OD X 24	0.14	1.63	BX	\$ 69.00		Custom		Custom		Custom
001360	** Grab Bar 1" OD X 36	0.15	1.96		\$ 77.00		\$104.00		Custom		Custom
001420	** Grab Bar 1" OD X 42	0.15	2.42		\$ 79.00		Custom		Custom		Custom

SERIES 857 GRAB BARS - 1" O.D.

Bradley Grab Bars are made of type-304, 18-gauge stainless steel. The exposed surfaces of the seamless constructed grab bar are available in an architectural satin (8570 Series), safety grip (8572), bright polished (8574), or safety grip with bright polished (8577 Series) finish.

Config. No.	Description	Shipping Data		(BX)	8570 Series	(BX)	8572 Series	(BX)	8574 Series	(BX)	8577 Series
		Cu. Ft.	Wt. Lbs		Price \$		Price \$		Price \$		Price \$
001420	** Grab Bar 1" OD X 42	1.1	5.00		\$ 107.00		Custom		Custom		Custom

Notes:

Custom: These are Custom order Grab Bars. Please contact customer service for a quotation. Custom Grab Bars are available in 1" increments.

The 001 style Grab Bar can be ordered in lieu of a corridor railing if the length is less than 54" in length.

For information on other available sizes, options, and prices not listed on this page please contact your local Sales Representative or Customer Service.









Washroom Accessories Division

TEL: 1-800-BRADLEY FAX: 262-251-5817
 Web Site: www.bradleycorp.com

Effective Date March 31, 2023

Series 900 - Hotel, Hospital/Patient Care, Custodial Accessories

	Model No.	Description	Shipping Data		Price Each \$	
			Cu. Ft.	Wt. Lbs.		
	900	900 Soap Dish - Extra Heavy Duty, Stainless Steel	0.2	1.50	\$ 55.00	BX
OPTIONS (Model 900)	-59	Anchor Plate	0	0.00	*	
	-61	Self Tapping Wood Screws	0	0.00	*	
	*901	901 Soap Dish	0.02	0.56	\$ 23.00	
	901-60	Soap Dish with Drain Holes	0.01	0.59	\$ 23.00	
	9014	Soap Dish with Drain Holes - Satin Stainless Steel	0.02	0.40	\$ 13.00	BX
	9014-63	Soap Dish Less Drain Holes - Satin Stainless Steel	0.04	0.33	\$ 23.00	BX
	9015	Soap Dish with Drain Holes - Bright Polish	0.02	0.43	\$ 20.00	BX
	9015-63	Soap Dish Less Drain Holes - Bright Polish	0.04	0.32	\$ 23.00	BX
	*904	9044 Tumbler/Toothbrush Holder - Satin Stainless Steel	0.02	0.35	\$ 14.00	BX
	9045	Tumbler/Toothbrush Holder - Bright Polish	0.02	0.34	\$ 17.00	
	*905	9054-12" Towel Bar - Square, Satin Stainless Steel	0.03	0.55	\$ 32.00	
	9054-18"	Towel Bar - Square, Satin Stainless Steel	0.05	0.60	\$ 32.00	BX
	9054-21"	Towel Bar - Square, Satin Stainless Steel	0.06	0.67	\$ 38.00	BX
	9054-24"	Towel Bar - Square, Satin Stainless Steel	0.2	0.66	\$ 42.00	BX
	9054-30"	Towel Bar - Square, Satin Stainless Steel	0.2	0.77	\$ 46.00	
	9055-12"	Towel Bar - Square, Bright Polish	0.03	0.55	\$ 30.00	
	9055-14"	Towel Bar - Square, Bright Polish	0.05	0.60	\$ 31.00	
	9055-18"	Towel Bar - Square, Bright Polish	0.1	0.66	\$ 34.00	BX
	9055-22"	Towel Bar - Square, Bright Polish	0.2	0.70	\$ 37.00	BX
	9055-24"	Towel Bar - Square, Bright Polish	0.2	0.74	\$ 38.00	BX
	*906	9065-16" Towel Bar - Round, Satin Stainless Steel	0.1	1.00	\$ 30.00	
	9065-18"	Towel Bar - Round, Satin Stainless Steel	0.1	1.00	\$ 31.00	BX
	9065-24"	Towel Bar - Round, Satin Stainless Steel	0.2	1.91	\$ 42.00	BX
	9065-30"	Towel Bar - Round, Satin Stainless Steel	0.2	1.05	\$ 46.00	
	9066-12"	Towel Bar - Round, Bright Polish	0.1	0.69	\$ 32.00	
	9066-18"	Towel Bar - Round, Bright Polish	0.1	0.69	\$ 32.00	BX
	9066-24"	Towel Bar - Round, Bright Polish	0.1	1.50	\$ 34.00	BX
	9066-30"	Towel Bar - Round, Bright Polish	0.2	0.84	\$ 41.00	
	907	907-18" Towel Bar - Square, Chrome Plated Brass	0.09	1.22	\$ 51.00	
	907-24"	Towel Bar - Square, Chrome Plated Brass	0.15	1.32	\$ 52.00	
	907-36"	Towel Bar - Square, Chrome Plated Brass	0.26	1.41	\$ 59.00	
	908	908-12" Towel Bar - Round, Stainless Steel, Chrome Plated Posts	0.12	1.55	\$ 55.00	
	908-15"	Towel Bar - Round, Stainless Steel, Chrome Plated Posts	0.14	1.67	\$ 57.00	
	908-18"	Towel Bar - Round, Stainless Steel, Chrome Plated Posts	0.2	1.80	\$ 53.00	
	908-20"	Towel Bar - Round, Stainless Steel, Chrome Plated Posts	0.19	1.87	\$ 55.00	
	908-24"	Towel Bar - Round, Stainless Steel, Chrome Plated Posts	0.2	2.00	\$ 56.00	BX
	908-26"	Towel Bar - Round, Stainless Steel, Chrome Plated Posts	0.25	2.12	\$ 59.00	
	908-30"	Towel Bar - Round, Stainless Steel, Chrome Plated Posts	0.3	2.20	\$ 61.00	
	908-32"	Towel Bar - Round, Stainless Steel, Chrome Plated Posts	0.31	2.36	\$ 65.00	
	909	9094-18" Shelf - Satin Stainless Steel	0.04	1.12	\$ 57.00	
	9094-24"	Shelf - Satin Stainless Steel	0.03	1.39	\$ 66.00	
	9095-18"	Shelf - Bright Polish	0.19	1.75	\$ 64.00	
	9095-16"	Shelf - Bright Polish	0.17	1.55	\$ 82.00	
	9095-24"	Shelf - Bright Polish	0.03	3.00	\$ 70.00	
*OPTIONS	-US	Domestic	0.00	0.00	*	

Notes *For information on options on this page please contact your local Sales Representative or Customer Service

Prices subject to change without notice.
 Items may be changed or discontinued without notice
 and without incurring obligation.





Washroom Accessories Division

TEL: 1-800-BRADLEY FAX: 262-251-5817

Web Site: www.bradleycorp.com

Effective Date March 31, 2023

Series 900 - Hotel, Hospital/Patient Care, Custodial Accessories

	Model No.	Description	Shipping Data		Price Each \$	
			Cu. Ft.	Wt. Lbs.		
	910 9104-18"	Towel Shelf - Satin Stainless Steel	0.95	3.50	\$ 57.00	
	9104-1890	Towel Shelf With Bar - Satin Stainless Steel	0.96	2.18	\$ 65.00	
	9104-24"	Towel Shelf - Satin Stainless Steel	0.47	2.04	\$ 66.00	
	9104-2490	Towel Shelf With Bar - Satin Stainless Steel	0.72	2.43	\$ 88.00	
	9105-18"	Towel Shelf - Bright Polish	0.19	0.90	\$ 57.00	
	9105-24"	Towel Shelf - Bright Polish	0.44	2.03	\$ 64.00	
	9105-1890	Towel Shelf With Bar - Bright Polish	0.50	2.03	\$ 72.00	
	9105-2490	Towel Shelf With Bar - Bright Polish	0.58	2.43	\$ 88.00	
	*911 911	Single Robe Hook - Brass, Chrome Plated	0.01	0.30	\$ 13.00	BX
	9111	Single Robe Hook - Stainless Steel	0.01	0.15	\$ 21.00	
	9114	Single Robe Hook - Satin Stainless Steel	0.01	0.21	\$ 13.00	BX
	9115	Single Robe Hook - Bright Polish Stainless Steel	0.01	0.24	\$ 14.00	BX
	9118	Single Robe Hook - Heavy Duty, Chrome Plated	0.02	0.77	\$ 28.00	BX
	9118-81	Single Robe Hook - Heavy Duty, Satin Chrome	0.02	1.00	\$ 28.00	BX
	9119	Single Robe Hook - Heavy Duty, Chrome Plated	0.03	0.51	\$ 28.00	BX
	9119-81	Single Robe Hook - Heavy Duty, Satin Chrome	0.03	0.78	\$ 28.00	BX
	*912 912	Double Robe Hook - Chrome Plated Brass	0.01	0.30	\$ 13.00	BX
	9124	Double Robe Hook - Satin Stainless Steel	0.01	0.33	\$ 14.00	BX
	9125	Double Robe Hook - Bright Polish	0.01	0.31	\$ 14.00	BX
	9134	Hat and Coat Hook - Satin Stainless Steel	0.02	0.41	\$ 57.00	BX
	9135	Hat and Coat Hook - Bright Polish	0.07	0.40	\$ 57.00	BX
*914 914	Double Coat Hook - Exposed Mtg., Chrome Plated Brass	0.04	1.00	\$ 20.00	BX	
*915 915	Hook and Bumper - Chrome Plated Brass	0.02	1.00	\$ 8.00	BX	
916 9164	Bottle Opener - Satin Stainless Steel	0.01	0.10	\$ 8.00		
917 917	Clothes Hook - Exposed Mtg., Stainless Steel	0.01	0.15	\$ 21.00	BX	
*OPTIONS	-US	Domestic	0.00	0.00	*	

Prices subject to change without notice.
 Items may be changed or discontinued without notice
 and without incurring obligation.







Washroom Accessories Division

TEL: 1-800-BRADLEY FAX: 262-251-5817
 Web Site: www.bradleycorp.com

Effective Date March 31, 2023

Series 900 - Hotel, Hospital/Patient Care, Custodial Accessories

	Model No.	Description	Shipping Data		Price Each \$	
			Cu. Ft.	Wt. Lbs.		
	921	Soap Dish - Chrome Plated Zamac	1.03	0.31	\$ 10.00	BX
	921-60	Soap Dish with Drain Holes - Chrome Plated Zamac	0.02	0.35	\$ 19.00	
					\$ -	
	924	Tumbler/Toothbrush Holder - Chrome Plated Zamac	0.02	0.34	\$ 13.00	
	926	926-18" Towel Bar - Round, Chrome Plated Zamac	0.07	0.69	\$ 19.00	
		926-24" Towel Bar - Round, Chrome Plated Zamac	0.09	0.76	\$ 20.00	
	927	927-11" Towel Bar - Square, Chrome Plated Zamac	0.04	1.50	\$ 32.00	
		927-12" Towel Bar - Square, Chrome Plated Zamac	0.05	1.50	\$ 34.00	
		927-18" Towel Bar - Square, Chrome Plated Zamac	0.07	0.55	\$ 19.00	BX
		927-24" Towel Bar - Square, Chrome Plated Zamac	0.09	0.50	\$ 20.00	BX
	9301-18"	Towel Shelf With Bar - Chrome Plated Zamac	0.46	2.47	\$ 114.00	
	9301-24"	Towel Shelf With Bar - Chrome Plated Zamac	0.01	2.67	\$ 117.00	
	*931	931 Single Robe Hook - Chrome Plated Zamac	0.01	0.19	\$ 6.00	BX
		9311 Towel Hook - Chrome Plated Zamac	0.02	0.30	\$ 19.00	
		9314 Towel Hook - Satin Stainless Steel	0.01	0.32	\$ 13.00	BX
		9315 Towel Hook - Bright Polish	0.03	0.26	\$ 22.00	BX
	932	Double Robe Hook - Chrome Plated Zamac	0.01	0.18	\$ 6.00	BX
	*933	9334 Towel Ring - Satin Stainless Steel	0.03	0.47	\$ 19.00	BX
		9335 Towel Ring - Bright Polish	0.03	0.46	\$ 22.00	BX
	934	Towel Ring - Chrome Plated Zamac	0.04	0.28	\$ 13.00	BX
	*935	9352 Soap Dish - Recessed, Bright Polish	0.09	0.69	\$ 32.00	
		9353 Soap Dish - Recessed, Stainless Steel	0.10	0.69	\$ 32.00	
		9362 Soap Dish With Bar - Bright Polish	0.10	1.40	\$ 34.00	
	*OPTIONS	-55 Back clamp for gypsum wallboard mounting	0.00	0.00	*	

Prices subject to change without notice.
 Items may be changed or discontinued without notice
 and without incurring obligation.











Washroom Accessories Division

TEL: 1-800-BRADLEY FAX: 262-251-5817

Web Site: www.bradleycorp.com

Effective Date March 31, 2023

Series 900 - Hotel, Hospital/Patient Care, Custodial Accessories

	Model No.	Description	Shipping Data		Price Each \$	
			Cu. Ft.	Wt. Lbs.		
	940	Soap Dish With Bar - Recessed, Stainless Steel, w/ Mortar Lugs	0.10	1.31	\$49.00	
	9401	Soap Dish - Recessed, Stainless Steel, with Mortar Lugs	0.07	0.93	\$41.00	
	9401-US	Domestic 9401	0.07	0.93	\$94.00	
	9402	Soap Dish With Bar - Recessed, with wall clamp	0.16	1.80	\$53.00	
	9403	Soap Dish - Recessed, with wall clamp	0.08	2.50	\$38.00	BX
	9403-US	Domestic 9403	0.08	2.50	\$172.00	
	947	Retractable Clothesline	0.02	0.52	\$26.00	
	949	Cup Dispenser - Surface-Mtd.	0.80	3.75	\$571.00	
	9495	Cup Dispenser - Surface-Mtd., Stainless Steel	0.39	2.74	\$143.00	
	9522	9522-060 Shower Rod Ceiling Support - required for rods longer than 72" Chrome Plated Brass, For 1 1/4" O.D. Rod, 6" St'd *Other sizes are available.	0.01	0.24	\$63.00	
	9530	9530-60 Curved Shower Curtain Rod - 60" Satin Finish	0.59	2.50	\$86.00	BX
		9530-6078 Curved Shower Curtain Rod - 60" High Polish Finish	0.59	2.50	\$84.00	BX
		9530-72 Curved Shower Curtain Rod - 72" Satin Finish	0.71	3.30	\$101.00	
		9530-7278 Curved Shower Curtain Rod - 72" High Polish Finish	0.71	3.30	\$99.00	
	9536	9536 Shower Curtain Hook, each	0.01	0.01	\$1.00	BX
		9536-US Domestic 9536	0.01	0.01	\$2.00	
		9540 Shower Curtain Hook with Roller, each	0.01	0.02	\$1.00	BX
	953	953 Shower Rod - 18 Gauge Stainless Steel, Exposed Flange				
	O.D.	953-036 Shower Rod - 36" Length	0.14	1.65	\$38.00	BX
		953-048 Shower Rod - 48" Length	0.18	2.26	\$46.00	BX
		953-060 Shower Rod - 60" Length	0.23	2.63	\$51.00	BX
		953-072 Shower Rod - 72" Length	0.27	3.09	\$66.00	BX
	9538	9538 Shower Rod - 18 Gauge Stainless Steel, Concealed Flange				
	O.D.	9538-036 Shower Rod - 36" Length	0.17	1.79	\$42.00	BX
		9538-042 Shower Rod - 42" Length	0.20	2.06	\$55.00	BX
		9538-048 Shower Rod - 48" Length	0.23	2.31	\$53.00	BX
		9538-060 Shower Rod - 60" Length	0.28	2.91	\$61.00	BX
		9538-072 Shower Rod - 72" Length	0.34	3.34	\$73.00	BX
	9531	9531 Shower Rod - 18 Gauge Stainless Steel, Exposed Flange				
	O.D.	9531-036 Shower Rod - 36" Length	0.17	2.01	\$38.00	BX
		9531-042 Shower Rod - 42" Length	0.20	2.44	\$41.00	BX
		9531-048 Shower Rod - 48" Length	0.23	2.66	\$42.00	BX
		9531-060 Shower Rod - 60" Length	0.28	3.36	\$52.00	BX
		9531-072 Shower Rod - 72" Length	0.27	3.77	\$63.00	
	9539	9539 Shower Rod - 18 Gauge Stainless Steel, Concealed Flange				
	O.D.	9539-036 Shower Rod - 36" Length	0.17	2.18	\$63.00	BX
		9539-042 Shower Rod - 42" Length	0.17	3.41	\$73.00	
		9539-048 Shower Rod - 48" Length	0.23	2.95	\$70.00	BX
		9539-060 Shower Rod - 60" Length	0.28	3.46	\$71.00	BX
		9539-072 Shower Rod - 72" Length	0.34	4.08	\$88.00	BX
	OPTIONS	-4 Bright Polish Finish			*	

Models 953, 9531, 9538, 9539

Notes *For information on options on this page please contact your local Sales Representative or Customer Service

Prices subject to change without notice.
Items may be changed or discontinued without notice and without incurring obligation.





Washroom Accessories Division

TEL: 1-800-BRADLEY FAX: 262-251-5817
 Web Site: www.bradleycorp.com

Effective Date March 31, 2023

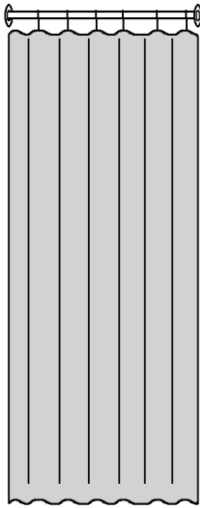
Series 900 - Hotel, Hospital/Patient Care, Custodial Accessories

	Model No.	Description	Shipping Data		Price Each \$	
			Cu. Ft.	Wt. Lbs.		
	13*	9533 Shower Curtain - 6 Ga. Vinyl, White				
		9533-3672 Shower Curtain - 6 Ga. Vinyl, White - 36"x72"	0.03	0.63	\$ 22.00	BX
		9533-4272 Shower Curtain - 6 Ga. Vinyl, White - 42"x72"	0.03	0.74	\$ 23.00	BX
		9533-4872 Shower Curtain - 6 Ga. Vinyl, White - 48"x72"	0.03	0.84	\$ 23.00	BX
		9533-6072 Shower Curtain - 6 Ga. Vinyl White - 60"x72"	0.05	1.05	\$ 28.00	BX
		9533-7272 Shower Curtain - 6 Ga. Vinyl, White - 72"x72"	0.05	1.26	\$ 28.00	BX
		35 9535 Shower Curtain - 10 oz. Nylon/Vinyl, Green				
		9535-3672 Shower Curtain - 10 oz. Nylon/Vinyl, - 36"x72"	0.09	1.19	\$ 49.00	
		9535-4272 Shower Curtain - 10 oz. Nylon/Vinyl, - 42"x72"	0.09	1.39	\$ 57.00	
		9535-4872 Shower Curtain - 10 oz. Nylon/Vinyl, - 48"x72"	0.09	1.59	\$ 59.00	
		9535-6072 Shower Curtain - 10 oz. Nylon/Vinyl, - 60"x72"	0.11	1.98	\$ 81.00	
		9535-7272 Shower Curtain - 10 oz. Nylon/Vinyl, - 72"x72"	0.11	2.38	\$ 81.00	
		37 9537 Shower Curtain - 10 oz. Nylon/Vinyl, White				
	9537-3672 Shower Curtain - 10 oz. Nylon/Vinyl, - 36"x72"	0.09	1.19	\$ 42.00	BX	
	9537-4272 Shower Curtain - 10 oz. Nylon/Vinyl, - 42"x72"	0.09	1.39	\$ 49.00	BX	
	9537-4872 Shower Curtain - 10 oz. Nylon/Vinyl, - 48"x72"	0.09	1.59	\$ 57.00	BX	
	9537-6072 Shower Curtain - 10 oz. Nylon/Vinyl, - 60"x72"	0.11	1.98	\$ 70.00	BX	
	9537-7272 Shower Curtain - 10 oz. Nylon/Vinyl, - 72"x72"	0.11	2.38	\$ 70.00	BX	
*Shower Curtain Sizes	Widths	36", 42", 48", 60" or 72"			*	
	Heights	72" or 78"			*	
	954	954 Shower Seat Hinged Corner - Stainless Steel	0.10	5.47	\$ 364.00	
		9541 Shower Seat Fixed Corner - Stainless Steel	0.16	4.52	\$ 249.00	
	956	9562 Folding Shower Seat - White, Phenolic, Barrier Free	0.47	22.40	\$ 785.00	BX
		9569 Reversible Shower Seat - White, Phenolic, Barrier Free	0.47	22.40	\$ 559.00	BX
		957 Bariatric Shower Seat - Phenolic, White, Left Hand	3.13	28.00	\$ 1,183.00	
		9571 Bariatric Shower Seat - Phenolic, White, Right Hand	3.13	28.00	\$ 1,123.00	
	958	958 Bariatric Shower Seat - Phenolic, White, Bench	3.13	27.00	\$ 1,382.00	
	959	9591 Folding Shower Seat - White, Phenolic	1.25	12.90	\$ 637.00	BX
		9592 Folding Shower Seat - White, Bradmar	1.25	14.65	\$ 668.00	BX
		9593 Folding Shower Seat - White, Bradmar, Barrier Free	2.88	22.76	\$ 745.00	BX
	9594 Reversible Shower Seat - White, Bradmar, Barrier Free	2.88	29.07	\$ 941.00	BX	
	962	962 Stainless Steel Baby Changing Station - Recessed	3.28	55.00	\$ 2,314.00	BX
		962-11 Stainless Steel Baby Changing Station - Surface-Mtd.	3.28	65.00	\$ 3,094.00	BX
	963	963 Baby Changing Station - Surf-Mtd, Gray/White Speckled, Rect.	1.68	17.40	\$ 444.00	BX
		9631 Baby Changing Station - Surf-Mtd, Light Grey, Rectangular	1.68	17.40	\$ 444.00	BX
		9632 Baby Changing Station - Surf-Mtd, Cream, Rectangular	1.68	17.40	\$ 503.00	BX
	964	964 Toddler Seat - Light Grey	0.53	5.71	\$ 169.00	BX

*For information on options on this page please contact your local Sales Representative or Customer Service

Notes

Prices subject to change without notice.
 Items may be changed or discontinued without notice
 and without incurring obligation.







Washroom Accessories Division

TEL: 1-800-BRADLEY FAX: 262-251-5817
Web Site: www.bradleycorp.com

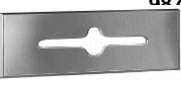
Effective Date March 31, 2023

Series 900 - Hotel, Hospital/Patient Care, Custodial Accessories

	Model No.	Description	Shipping Data		Price Each \$	
			Cu. Ft.	Wt. Lbs.		
	9661	Medicine Cabinet - Recessed, 16" x 22", Polystyrene	1.78	9.00	\$ 146.00	BX
	9663	Medicine Cabinet - Recessed, 16" x 26"	2.69	16.20	\$ 128.00	BX
	9664	Medicine Cabinet - Surface-Mtd., 16" x 22"	1.05	13.50	\$ 148.00	BX
	175	Medicine Cabinet - Recessed, Stainless Steel	1.92	28.54	\$ 594.00	BX
	175-10	Medicine Cabinet - Semi-Recessed, Stainless Steel	1.92	31.00	\$ 747.00	
	175-11	Medicine Cabinet - Surface-Mtd., Stainless Steel	1.92	31.67	\$ 777.00	
175 Optional Features	-22	Tempered glass in lieu of float glass			*	
	-23	#8 stainless steel mirror in lieu of float glass			*	
	-21	Satin stainless steel door in lieu of float glass			*	
	-75	430 stainless steel mirror in lieu of float glass			*	
9813	9813	Specimen Pass-Thru Cabinet	1.56	11.42	\$ 416.00	BX
		987	Facial Tissue Dispenser - Recessed, Satin Finish	0.11	1.72	\$ 50.00
987-78		Facial Tissue Dispenser - Recessed, Polished	0.11	2.00	\$ 50.00	
987-11		Facial Tissue Dispenser - Surface-Mtd.	0.28	2.09	\$ 68.00	
987-36		Facial Tissue Dispenser - Recessed, Large Capacity	0.18	2.12	\$ 50.00	BX
	989	Needle Disposal - Recessed, Satin Finish	1.18	11.50	\$ 357.00	BX
	989-11	Needle Disposal - Surface-Mtd. Satin Finish	1.18	13.20	\$ 577.00	
	990	LeakProof Bed Pan Storage Cabinet - Recessed	3.24	21.50	\$ 727.00	
	990-11	LeakProof Bed Pan Storage Cabinet - Surface-Mtd.	3.24	23.15	\$ 1,031.00	
	9905	Bed Pan/Urinal Holder - Surface-Mtd.	2.63	10.00	\$ 191.00	
	991	Corner Guard - 40"	0.46	5.07	\$ 107.00	
	991-48	Corner Guard - 48"	0.64	6.00	\$ 135.00	
	991-60	Corner Guard - 60"	0.80	8.00	\$ 124.00	
	991-72	Corner Guard - 72"	1.00	10.00	\$ 144.00	
		*Other sizes are available				*
993	9933	Utility Shelf - Surface-Mtd., 34"	4.49	19.14	\$ 327.00	BX
	9934	Utility Shelf - Surface-Mtd., 44"	4.49	24.80	\$ 462.00	
994	9943	Hat and Coat Rack - Surface-Mtd., 24"	0.58	3.00	\$ 103.00	BX
	9944	Hat and Coat Rack - Surface-Mtd., 36"	1.00	3.81	\$ 114.00	
	9945	Hat and Coat Rack - Surface-Mtd., 48"	1.00	4.36	\$ 147.00	
	9946	Hat and Coat Rack - Surface-Mtd., 60"	1.48	5.64	\$ 176.00	
995	9953	Mop and Broom Holder - Surface-Mtd., 24"	0.43	2.50	\$ 107.00	BX
	9954	Mop and Broom Holder - Surface-Mtd., 36"	0.43	4.00	\$ 123.00	BX
	9955	Mop and Broom Holder - Surface-Mtd., 48"	0.46	4.91	\$ 139.00	
998	9983	Utility Shelf - Surface-Mtd., 30"	1.93	9.38	\$ 255.00	
	9984	Utility Shelf - Surface-Mtd., 36"	2.20	10.00	\$ 255.00	BX
	9985	Utility Shelf - Surface-Mtd., 42"	1.93	14.62	\$ 275.00	
	9986	Utility Shelf - Surface-Mtd., 48"	1.93	16.43	\$ 339.00	

Notes

*For information on options on this page please contact your local Sales Representative or Customer Service

Prices subject to change without notice.
Items may be changed or discontinued without notice
and without incurring obligation.









Washroom Accessories Division

TEL: 1-800-BRADLEY FAX: 262-251-5817

Web Site: www.bradleycorp.com

Prison/Detention Center Accessories

Effective Date March 31, 2023

	Model No.	Description	Shipping Data		Price Each \$	
			Cu. Ft.	Wt. Lbs.		
SECURITY MIRRORS 	SA01-1	12" x 16", Type 304 #8 Stainless Steel Mirror, Chase Mtd.*	0.52	10.00	\$ 264.00	
	SA01-2	12" x 16", Type 430, Brite Annealed Mirror, Chase Mtd.*	0.14	7.53	\$ 251.00	
	SA01-5	12" x 16", Plexiglass Mirror, Chase Mtd.*	0.78	18.00	\$ 398.00	
	SA03-1	12" x 16", Type 304 #8 Stainless Steel Mirror, Front Mtd.	0.52	6.73	\$ 212.00	
	SA03-2	12" x 16", Type 430, Brite Annealed Mirror, Front Mtd.	0.52	6.72	\$ 198.00	
	SA03-5	12" x 16", Plexiglass Mirror, Front Mtd.	0.59	18.00	\$ 281.00	
INTEGRAL MIRRORS	SA05	Integral Framed Stainless Steel Mirror, 11-1/4" x 17-1/4"	0.56	5.00	\$ 198.00	
TOILET TISSUE HOLDER 	SA09	Chase Mtd.*	0.06	3.00	\$ 160.00	
	SA10	Front Mtd.	0.40	2.00	\$ 81.00	
	SA11	Chase Mtd.*	0.22	5.00	\$ 169.00	
	SA12	Front Mtd.	0.12	3.00	\$ 155.00	BX
	SA13	Chase Mtd.*	0.06	4.00	\$ 266.00	
	SA14	Front Mtd.	0.21	4.00	\$ 190.00	
SOAP DISH 	SA16	Chase Mtd.*	0.16	2.00	\$ 97.00	
	SA22	Front Mtd.	0.03	1.00	\$ 55.00	
SAFETY TOWEL HOOK	SA30	Chase Mtd.*	0.03	1.23	\$ 242.00	
	SA31	Front Mtd.	0.04	0.91	\$ 113.00	BX
	SA35	Chase Mtd.*	0.02	1.00	\$ 191.00	
	SA36	Front Mtd.	0.04	0.87	\$ 129.00	BX
SAFETY CLOTHES HOOK STRIP 	SA32	Chase Mtd.*	0.19	6.00	\$ 419.00	
	SA33	Front Mtd.	0.50	4.50	\$ 392.00	
	SA37	Front Mtd.	0.01	0.41	\$ 42.00	BX
	SA38	Chase Mtd.*	0.38	5.00	\$ 357.00	
	SA39	Front Mtd.	0.50	4.43	\$ 219.00	
	SA41	Front Mtd.	0.52	7.00	\$ 455.00	
SHELF 	SA47	Chase Mtd.*	0.31	6.00	\$ 406.00	
	SA49	Chase Mtd.*	0.12	8.00	\$ 275.00	
	SA50	With Toothbrush Holders.*	0.13	8.00	\$ 310.00	
BOOKSHELF 	SA51	With Clothes Hooks - Stainless Steel, Chase Mtd.*	1.56	11.00	\$ 777.00	
	SA52	With Clothes Hooks - Stainless Steel, Front Mtd.	1.56	15.00	\$ 733.00	
	SA53	With Clothes Hooks - Chase Mtd.*	1.25	16.00	\$ 715.00	
	SA54	With Clothes Hooks - Front Mtd.	1.56	16.00	\$ 553.00	
	SA55	Chase Mtd.*	0.63	8.00	\$ 387.00	
	SA56	Front Mtd.	0.63	8.00	\$ 369.00	
SECURITY GRAB BAR	SA70-00118	Security Grab Bar, Front Mtd.	0.13	3.50	\$ 166.00	BX
	SA70-00124	Security Grab Bar, Front Mtd.	0.17	3.67	\$ 177.00	BX
	SA70-00136	Security Grab Bar, Front Mtd.	0.24	5.26	\$ 181.00	BX
	SA70-00142	Security Grab Bar, Front Mtd.	0.28	6.01	\$ 208.00	BX
	SA70-00260	Security Grab Bar, Front Mtd.	0.39	8.75	\$ 467.00	BX

NOTES

*All Chase Mtd. items are priced for a 6" wall.

Prices subject to change without notice.
 Items may be changed or discontinued without notice
 and without incurring obligation.